

Kaweah Project, FERC Project No. 298

CUL 1 – Cultural Resources Built Environment Final Technical Study Report

December 2019



Southern California Edison Company
Regulatory Support Services
1515 Walnut Grove Avenue, Rosemead, CA 91770

Table of Contents

1	Introduction	1
1.1	Regulatory Context.....	1
2	Study Objectives	2
3	Extent of Study Area	2
4	Study Approach.....	7
4.1	Research Methods	7
4.2	Survey Methods.....	8
4.3	Personnel Qualifications.....	8
5	Study Results	8
5.1	Survey Population	8
5.2	Records Research.....	10
5.3	Historical Context for Development.....	10
5.3.1	Contextual Overview	10
5.3.2	Growth of Hydroelectric Capacity in California	11
5.3.3	Mount Whitney Power Company: Hydroelectricity and Agricultural Development	13
5.3.4	Physical Development of the Kaweah System	15
5.3.5	Industry Consolidation and Absorption by SCE	31
5.3.6	Kaweah Project Operations under SCE Ownership	32
5.3.7	Context Summary	34
5.4	Updated National Register of Historic Places Inventory	35
5.4.1	Kaweah No. 1 Development	35
5.4.2	Kaweah No. 2 Development	43
5.4.3	Kaweah No. 3 Development	47
5.4.4	Built Environment Resources Associated with General Project Operations.....	59
5.5	Updated and New National Register of Historic Places Evaluation	61
5.5.1	Evaluative Framework.....	61
5.5.2	Previous Resource Evaluations	62
5.5.3	Updated Resource Evaluation	63
6	Conclusions.....	73
6.1	Findings	73
6.2	Continuing Documentation Efforts.....	73
7	Literature Cited.....	74

List of Appendices

Appendix A	Architectural Area of Potential Effects (APE)
Appendix B	Department of Parks and Recreation (DPR) Forms
Appendix C	History and Significance Evaluation of the Kaweah Hydroelectric System (1989)
Appendix D	Archival Drawings and Plans

List of Tables

Table CUL 5-1	Historic Period Built Environment Survey Population.....	9
Table CUL 5-2	SCE Kaweah Stream Gages	60
Table CUL 5-3	Updated NRHP Status of Built Environment Resources Associated with the Kaweah No. 1 Development	65
Table CUL 5-4	Updated NRHP Status of Built Environment Resources Associated with the Kaweah No. 2 Development	66
Table CUL 5-5	Updated NRHP Status of Built Environment Resources Associated with the Kaweah No. 3 Development	67
Table CUL 5-6	NRHP Status of Built Environment Resources Associated with General Project Operations	72

List of Figures

Figure CUL 5-1	Founders of Mount Whitney Power Company, Hammond, Maddox, Wishon (l-r), ca. 1908.....	13
Figure CUL 5-2	Promotional Power Brochure, 1920.....	14
Figure CUL 5-3	Kaweah Powerhouse No. 1, 1904	15
Figure CUL 5-4	Interior of Powerhouse No. 1, circa 1900	15
Figure CUL 5-5	Kaweah No. 1 Diversion Dam, 1904.....	16
Figure CUL 5-6	Overview of Kaweah No. 1 Diversion Dam with Catwalk leading to Flume (l-r), 1908	16
Figure CUL 5-7	Representative Trestle Section of Kaweah No. 1 Flume, circa 1908	17
Figure CUL 5-8	Kaweah No. 1 Flume at Powerhouse No. 1 Penstock, circa 1908.....	17
Figure CUL 5-9	Kaweah No. 2 Powerhouse, 1904	19
Figure CUL 5-10	Interior of Powerhouse No. 2, circa 1908	19
Figure CUL 5-11	Kaweah No. 2 Diversion, 1908	20
Figure CUL 5-12	Kaweah No. 2 Concrete Ditch and Flume Section, circa 1908	21
Figure CUL 5-13	Kaweah No. 2 Forebay, 1908	21
Figure CUL 5-14	Monarch Lake Masonry Section, 1951	22
Figure CUL 5-15	Mount Whitney Power Company Demand Graph, 1913	23
Figure CUL 5-16	Kaweah No. 3 Powerhouse, 1920	24

Figure CUL 5-17 Kaweah No. 3 Powerhouse Interior Generating Room, 1920 25

Figure CUL 5-18 Middle Fork Diversion Dam, circa 1912..... 26

Figure CUL 5-19 Marble Fork Diversion Dam, circa 1913 26

Figure CUL 5-20 Marble Fork Flowline, circa 1912..... 27

Figure CUL 5-21 Marble Fork Siphon, circa 1912..... 28

Figure CUL 5-22 Middle Fork Flowline, circa 1912 29

Figure CUL 5-23 Kaweah No. 3 Forebay, 1947 30

Figure CUL 5-24 SCE's Kaweah Powerhouse No. 1, 1940 32

Figure CUL 5-25 SCE Crews Rebuilding Kaweah No. 1 Flume, 1947 33

Figure CUL 5-26 Rebuilt Kaweah No. 1 Flume, 1948 33

Figure CUL 5-27 Kaweah No.1 Flume Damage from “Mother Nature” 34

Figure CUL 5-28 Broken Section of Kaweah No. 1 Flume, 2018..... 34

Figure CUL 5-29 Kaweah No. 1 Powerhouse, camera facing west 36

Figure CUL 5-30 Kaweah No. 1 Penstock alignment, camera facing south 36

Figure CUL 5-31 Kaweah No. 1 Switchyard, camera facing northeast..... 37

Figure CUL 5-32 Kaweah No. 1 Diversion Dam and Sandbox, camera facing east..... 38

Figure CUL 5-33 Section of Kaweah No. 1 Flowline, camera facing southeast 38

Figure CUL 5-34 Kaweah No. 1 Forebay Tank, camera facing northeast 39

Figure CUL 5-35 Kaweah No. 1 Powerhouse Campus, camera facing northeast..... 40

Figure CUL 5-36 Eagle Lake Dam 41

Figure CUL 5-37 Lady Franklin Dam..... 41

Figure CUL 5-38 Upper Monarch Lake 42

Figure CUL 5-39 Crystal Lake Dam 42

Figure CUL 5-40 Kaweah No. 2 Powerhouse, camera facing west 43

Figure CUL 5-41 Kaweah No. 2 Penstock, camera facing north 44

Figure CUL 5-42 Kaweah No. 2 Switchyard, camera facing south 44

Figure CUL 5-43 Kaweah No. 2 Diversion Dam, camera facing west 45

Figure CUL 5-44 Kaweah No. 2 Flowline, camera facing west..... 46

Figure CUL 5-45 Flume Section of Kaweah No. 2 Flowline, camera facing west..... 46

Figure CUL 5-46 Kaweah No. 2 Forebay and Trash Rack, camera facing west 47

Figure CUL 5-47 Kaweah No. 3 Powerhouse, camera facing north 48

Figure CUL 5-48 Kaweah No. 3 Penstock, camera facing west 48

Figure CUL 5-49 Kaweah No. 3 Powerhouse Garage, camera facing northwest..... 49

Figure CUL 5-50 Kaweah No. 3 Powerhouse Bridge, camera facing west 49

Figure CUL 5-51 Marble Fork Diversion Dam, camera facing north..... 51

Figure CUL 5-52 Marble Fork Diversion Dam Sandbox, camera facing south 51

Figure CUL 5-53 Marble Fork Flowline flume section, camera facing southwest 52

Figure CUL 5-54 Marble Fork Flowline ditch section, camera facing southwest 52

Figure CUL 5-55 Marble Fork Siphon Headbox, camera facing southeast 53

Figure CUL 5-56 Marble Fork Siphon, camera facing east 53

Figure CUL 5-57 Junction of Marble Fork Siphon and Middle Fork Flowline 54

Figure CUL 5-58 Middle Fork Diversion Dam, camera facing east 55

Figure CUL 5-59 Middle Fork Diversion Dam Sandbox, camera facing west 55

Figure CUL 5-60 Middle Fork Flowline concrete box flume section, camera facing southwest 56

Figure CUL 5-61 Middle Fork Flowline concrete ditch section, camera facing south 57

Figure CUL 5-62 Middle Fork Flowline, representative buttress and pier, camera facing west 57

Figure CUL 5-63 Kaweah No. 3 Forebay, camera facing east 58

Figure CUL 5-64 Terminus of Kaweah No. 3 / Middle Fork Flowline at Kaweah No. 3 Forebay,
camera facing west 59

Figure CUL 5-65 Kaweah No. 3 Forebay Outlet, camera facing south 59

Figure CUL 5-66 Kaweah Stream Gage 201, camera facing south 59

Figure CUL 5-67 Kaweah Powerhouse No. 3 to Three Rivers Substation Transmission Line,
camera facing south 60

Figure CUL 5-68 Kaweah No. 1 Forebay Tank Communication Line, camera facing east 61

List of Maps

Map CUL 1-1 Kaweah Project Location 3

Map CUL 1-2 Kaweah Project Land Jurisdictions 5

Map CUL 5-1 Kaweah No. 3 Hydroelectric System NRHP Historic District Boundary 69

List of Acronyms

AC	Alternating Current
APE	Area of Potential Effects
BLM	Bureau of Land Management
CFR	Code of Federal Regulations
CRHR	California Register of Historical Resources
CRMP	Cultural Resource Management Plan
DC	Direct Current
DPR	Department of Parks and Recreation
FERC	Federal Energy Regulatory Commission
hp	Horsepower
HPD	Historic Properties Data File
ILP	Integrated Licensing Process
IOP	Institute of Physics
kV	kilovolt
kW	kilowatts
MW	megawatts
NAHC	Native American Heritage Commission
NHPA	National Historic Preservation Act
NPS	National Park Service
NR	National Register
NRHP	National Register of Historic Places
O&M	Operation and Maintenance
OHP	Office of Historic Preservation
PG&E	Pacific Gas and Electric Company
PLPC	Pacific Light and Power Company
PQS	Professional Qualification Standards
Project	Kaweah Hydroelectric Project
PSP	Proposed Study Plan
RSP	Revised Study Plan
SCE	Southern California Edison Company
SHPO	State Historic Preservation Officer
SJVIC	San Joaquin Valley Information Center
SNF	Sierra National Forest
SNP	Sequoia National Park
SOI	Secretary of the Interior

SUP	Special Use Permit
TSP	Technical Study Plan
TSR	Technical Study Report
TWG	Technical Working Group
USGS	United States Geological Survey

1 INTRODUCTION

Southern California Edison Company (SCE or Licensee) is seeking a new license for the existing Kaweah Hydroelectric Project (Project), Federal Energy Regulatory Commission (FERC) Project No. 298, located on the Kaweah River and East Fork Kaweah River near the community of Three Rivers in Tulare County, California (Map CUL 1-1). The Project is located on private lands and public lands administered by the Bureau of Land Management (BLM). The Project also utilizes non-FERC Project diversions and flowlines located within the Sequoia National Park (SNP) operated under a Special Use Permit (SUP) issued by the National Park Service (NPS).

The Kaweah Project (also referred to in this report as the “Kaweah System”) consists of three developments: Kaweah No. 1, Kaweah No. 2, and Kaweah No. 3, which commenced operation in June 1899, February 1905, and May 1913, respectively. The Project has limited storage capacity and is operated in a “run-of-river” mode. The total generating capacity is 8.85 megawatts (MW) (Map CUL 1-2).

SCE currently operates the Project under a 30-year license that was issued by FERC on January 31, 1992. The current license expires on December 31, 2021. SCE is seeking renewal of its license to continue operation and maintenance (O&M) of the Project. SCE has elected to use the Integrated Licensing Process (ILP), as defined in eighteen Code of Federal Regulations (CFR) Part 5, to relicense the Project. As a component of the ILP, the Licensee consulted with a variety of Interested Parties to develop and implement Technical Study Plans (TSP) addressing resources that may be affected by ongoing O&M of the Project.¹ On May 24, 2017, SCE filed its Proposed Study Plan (PSP) with FERC, which contained fifteen TSPs addressing aquatic resources, water quality, geomorphology, special-status amphibians and reptiles, terrestrial resources, land use, recreation, and cultural resources. SCE subsequently held a Study Plan Meeting with the Interested Parties on June 21, 2017, and filed its Revised Study Plan (RSP) on September 19, 2017². On October 24, 2017, FERC approved the SCE’s RSP in a Study Plan Determination pursuant to 18 CFR Part 5.13(c).

The FERC-approved CUL 1 – Cultural Resources TSP includes three study elements covering the built environment, archaeological and ethnographic resources. This Technical Study Report (TSR) documents the historic period built environment study components of the CUL 1 – TSP. Archaeological and ethnographic resources are documented independently, in two separate TSRs.

1.1 Regulatory Context

This TSR was prepared as part of the Licensee’s ILP process to comply with Section 106 of the National Historic Preservation Act (NHPA) (16 U.S.C. § 470f) and its implementing regulations in 36 CFR Part 800, which requires that Federal agencies consider the effect of undertakings on cultural resources. This TSR was developed on behalf of the Licensee as a component of the CUL 1 – TSP, and was developed in collaboration with a Cultural Resources Technical Working Group (TWG) that includes representatives from FERC, the California State Historic Preservation Officer (SHPO), the BLM, Tribes and Tribal Representatives identified by the Native American Heritage Commission (NAHC), and through SCE’s tribal outreach. As described above, this TSR addresses only the historic period built environment components of the CUL 1 – TSP, with the archaeological and ethnographic portions of the CUL 1 – TSP addressed in separate TSRs. For the purposes of this TSR, historic period built environment resources

¹ Under 18 CFR Part 5, FERC designated SCE as the Commission’s non-federal representatives for carrying out informal consultation under Section 106 of the NHPA in a Notice of Intent, February 10, 2017.

² Three comments were filed on the PSP, however, they did not result in revisions to any of the study plans. Therefore, on September 19, 2017, SCE filed a Revised Study Plan which stated that the PSP, without revision, constituted its RSP.

are considered to include all buildings, structures, and objects that were identified as over 45 years of age at the time of 2018 inventory, in accordance with the documentation requirements of the NHPA.³

2 STUDY OBJECTIVES

As documented in the FERC-approved CUL 1 – TSP, O&M of the Project could potentially affect building, structures, and objects that are listed in, or potentially eligible for listing in the National Register of Historic Places (NRHP), and as such affect historic properties as defined under Section 106 of the NHPA (as codified in 36 CFR Part 800). Because Section 106 requires FERC to ensure that their undertakings do not adversely affect historic properties, the objective of this TSR is to provide information regarding historic period built environment resources that will enable FERC, and the Licensee, to manage historic period built environment resources in the Project and avoid adverse effects to historic properties as defined in Section 106 of the NHPA. To this end, background research and field documentation undertaken as part of this TSR inventoried and evaluated all historic period built environment resources associated with the Project to determine if any appeared to be eligible for the NRHP, and as such appeared to be historic properties under Section 106 of the NHPA. The technical information included in this TSR will serve to support the development of appropriate management measures for historic properties that will be developed in consultation with the Interested Parties as part of the ILP.

3 EXTENT OF STUDY AREA

The Study Area for the CUL 1 – TSP was developed in accordance with the requirements of Section 106 of the NHPA, as codified in 36 CFR Part 800, which requires FERC to develop an Area of Potential Effect (APE) for the Project. Under 36 CFR Part 800, an APE is defined as “the geographic area or areas within which an undertaking may cause changes in the character or use of historic properties” (36 CFR 800.16[d]). An undertaking may have an adverse effect on historic properties when it directly or indirectly alters any of the characteristics of a historic property that qualify the property for inclusion in the NRHP in a manner that would diminish the integrity of the property’s location, design, setting, materials, workmanship, feeling, or association. Adverse effects can include but are not limited to: physical destruction of or damage to all or part of a historic property; alteration of a historic property that is not consistent with the Secretary of the Interior’s Standards for the Treatment of Historic Properties (36 CFR Part 68); removal of a historic property from its historic location; change of the character of the historic property’s use; introduction of visual, atmospheric, or audible elements that undermine the integrity of the property; neglect of a historic property; and transfer, lease, or sale of a property out of Federal ownership (36 CFR Part 800.5).

In order to determine the potential for direct or indirect effects on historic period built environment resources associated with the Project, qualified personnel under the Secretary of the Interior’s Professional Qualification Standards (SOI PQS) for Architectural History established an Architectural APE for the Project, in compliance with § 800.16(d) of 36 CFR Part 800. The Architectural APE includes the geographic areas within which operations of the FERC Project may directly or indirectly cause alterations in the character or use of built environment historic properties. The Architectural APE aligns with the FERC boundary for the Project, as O&M under the FERC license is limited to facilities within the FERC boundary. Mapping of the Architectural APE for the Project is included in Appendix A of this TSR.

³ Although the National Register of Historic Places (NRHP) and NHPA identify historic period built environment resources as those properties that are over 50 years of age, the threshold for this TSR was placed at 45 years of age to account for the consultation and review process. All built environment resources that were identified as over 45 years of age were considered in the “Survey Population”

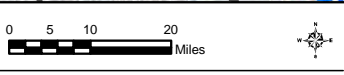
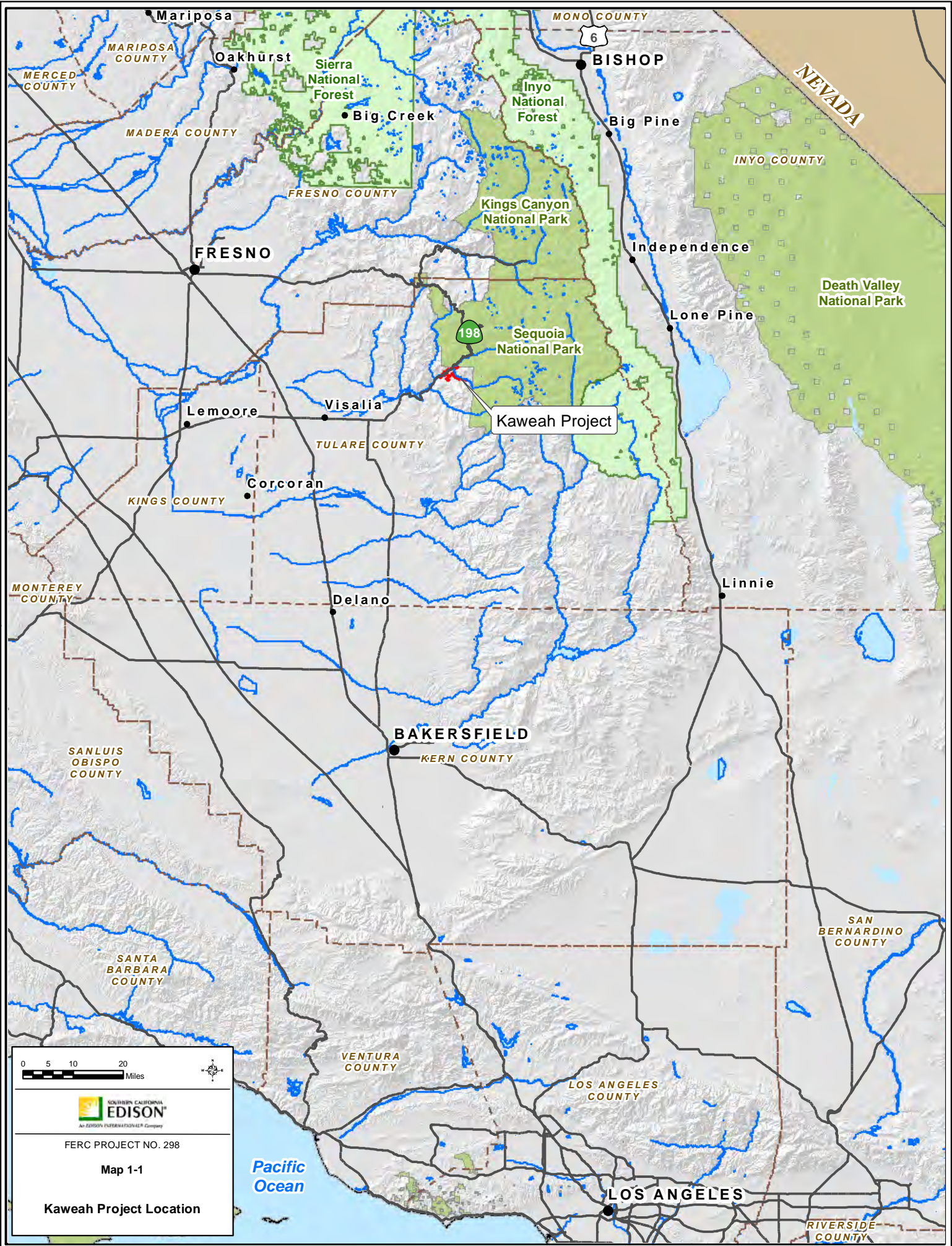

FERC PROJECT NO. 298

Map 1-1

Kaweah Project Location

C:\GIS\Cardinal\30735240_SCE_EasternHydro\map\Kaweah\SCE_Eastern_KAWEAH_Location_8111_01.mxd

This Page Intentionally Left Blank

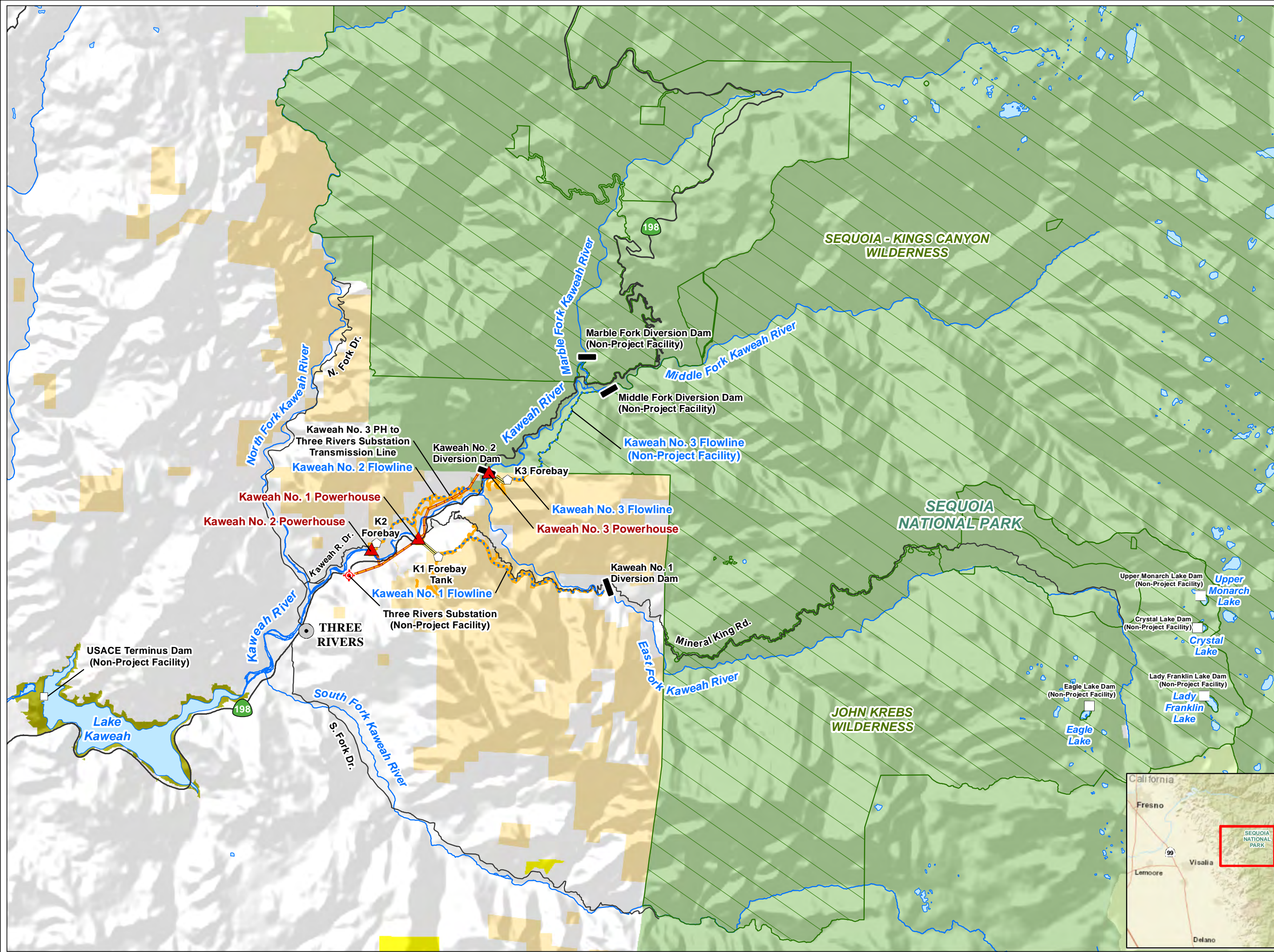

- ### Facilities
- Powerhouse
 - Diversion
 - Utility
 - Forebay
 - Gage
 - Flowline
 - Penstock
 - Transmission Line
 - Project FERC Boundary
- NOTE: The Marble and Middle Fork Diversion Dams are not in designated Wilderness

- ### Other Features
- City/Town
 - Highway/Road
 - Watercourse
 - Water Body

- ### Land Jurisdiction*
- Bureau of Land Management
 - U.S. Army Corps of Engineers
 - National Park Service
 - U. S. Forest Service
 - Private (Blank)
- *SOURCE: BLM 2012

- ### Land Management
- National Wilderness Area



**SOUTHERN CALIFORNIA
EDISON**
An EDISON INTERNATIONAL® Company

FERC Project No. 298

Map 1-2

**Kaweah Project
Land Jurisdictions**



Date: 10/10/2018

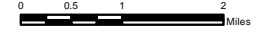

0 0.5 1 2 Miles

Projection: UTM Zone 11
Datum: NAD 83

Southern California Edison (SCE) has no reason to believe that there are any inaccuracies or defects with information incorporated in this work and make no representations of any kind, including, but not limited to, the warranties of merchantability or fitness for a particular use, nor are any such warranties to be implied, with respect to the information or data, furnished herein. No part of this map may be reproduced or transmitted in any form or by any means, electronic or mechanical, including photocopying and recording system, except as expressly permitted in writing by SCE.

Copyright 2018 by Southern California Edison Company

This Page Intentionally Left Blank

While the Architectural APE for the Project is limited to the FERC Project boundary, this TSR included analysis and documentation of SCE Kaweah Hydroelectric facilities that are located outside of the FERC Project boundary, on lands located within the SNP and operated under a SUP issued by the NPS, referred to herein as the SNP Study Area. Although these features are not under FERC jurisdiction and are instead managed under an NPS SUP, because the facilities are physically and contextually associated with contributing elements of the NRHP-eligible Kaweah No. 3 Hydroelectric System Historic District located in the FERC Project boundary, this analysis included inventory and NRHP evaluation of the facilities in order to provide contextual information for management of historic properties in the APE. This documentation approach was developed in collaboration with SHPO and representatives of the OHP.⁴

The Architectural APE is buffered by a 1-mile Record Search Study Area, within which qualified personnel under the SOI PQS conducted a formal review of records held by the OHP San Joaquin Valley Information Center (SJVIC) and the BLM. While this Study Area was not subject to inventory as part of the CUL 1 -TSR, the information was utilized for contextual purposes in development of the TSR.

4 STUDY APPROACH

4.1 Research Methods

Qualified personnel conducted background research and property investigation from January to August of 2018, accounting for all built environment buildings, structures, and objects identified in this TSR. Background research included review of the following sources:

- SCE facilities records;
- Previous cultural resource reports on file with SCE and the SJVIC;
- SCE archival drawings, plans, and photographs;
- SCE Cultural Resources Management Documents, including the *Cultural Resources Management Plan for the Kaweah Hydroelectric Project* and the *SCE Historic-Era Electrical Infrastructure Management Program Document*;
- Historic period United States Geological Survey (USGS) topographic maps;
- Archival records stored at the Three Rivers Historical Museum, Three Rivers, CA;
- Digital Library of the Huntington Library;
- Archival records of the Tulare County Historical Society, Visalia, CA;
- Interviews with Kaweah Hydroelectric Project personnel;
- Engineering periodicals; and
- Contextual sources on California hydroelectric development.

This archival and secondary research was used to create a development and evaluative context for the historic period built environment resources located in the Architectural APE. Research focused on the development history of resources documented in this report, as well as the general thematic development context for the Architectural APE, specifically late nineteenth and early twentieth century hydroelectric development in California's Sierra Nevada and the development of hydroelectric capacity for agricultural irrigation.

⁴ SHPO provided comments on the Study Area and proposed APE in a letter dated May 3, 2018, Reference Number: FERC_2018_0309_001. In addition, a representative of the Office of Historic Preservation (OHP) attended a March 20, 2018, Cultural Resources TWG meeting and provided verbal comments requesting the consideration of historic period built environment facilities associated with the Kaweah Hydroelectric Project located in the SNP for contextual purposes.

In addition to this comprehensive archival and secondary research, Interested Parties with knowledge of the resources in the Architectural APE were consulted in accordance with the requirements of Section 106. On March 20, 2018, SCE convened a TWG meeting addressing cultural resources, including built environment resources. Representatives of the BLM, OHP, and other interested individuals were in attendance at the meeting and were invited to provide comments and information regarding built environment resources. Representatives of the Tulare County Historical Society and the Three Rivers Historical Society were invited to the meeting and are on the distribution list for the Cultural Resources TWG, but to date neither organization has provided comments or information regarding built environment resources. This TSR will be distributed to all Interested Parties for review, and comments will be addressed in the Final TSR, as appropriate.

4.2 Survey Methods

All built environment resources (buildings, structures, objects) that were determined to be over 45 years of age were included as part of the Survey Population and subject to intensive field inventory and evaluation, which is documented in detail on the California Department of Parks and Recreation (DPR) Records contained in Appendix B of this TSR. Field surveys were conducted in April and May 2018. The inventory consisted of comprehensive written and photographic documentation of all historic period built environment resources located within the APE and SNP Study Area. For those properties that had been previously inventoried and evaluated and had formal OHP status, the survey effort focused on assessing each property relative to the previous documentation recording any changes that may have occurred. For multi-component resources, including powerhouse complexes with multiple related buildings and structures, and linear water conveyance alignments with multiple integrated features, the survey effort included documentation of each individual building, structure, or object within the multi-component resource.

4.3 Personnel Qualifications

SCE contracted with Cardno, Inc. (Cardno) to prepare this TSR. This TSR was prepared under the supervision of Senior Architectural Historian and Cultural Resources Task Lead, Polly Allen (MS and 16 years of experience), who also conducted research and fieldwork in support of the Project and authored this report. Architectural Historian Matt Walker (MA and 6 years of experience) conducted fieldwork and archival research and authored the DPR 523 forms contained in Appendix B. Both personnel meet the SOI PQS in History and Architectural History (36 CFR Part 61) and have extensive experience documenting and evaluation hydroelectric properties in California. All analysis included in this TSR was conducted under the supervision of SCE Senior Archaeologist, Audry Williams, who also meets the SOI PQS. Senior GIS Specialist Eric Lee created all mapping and graphics included in this TSR.

5 STUDY RESULTS

The following section summarizes the results of implementation of the TSP and the findings of this TSR, with detail regarding the Survey Population, research undertaken, historic context for the APE, and built environment inventory and evaluation analysis.

5.1 Survey Population

The Project APE and SNP Study Area includes 18 historic period built environment resources that are all associated with ongoing hydroelectric development of the Kaweah River by SCE and nineteenth century predecessor company, Mount Whitney Power Company. These resources, collectively referred to herein as the Survey Population, was developed based on background review of the Project APE and SNP Study Area, as described in Section 4: Study Approach. The features and facilities that comprise the Survey Population are identified in Table CUL 5-1, and described in detail in Section 5.3: Resource Inventory and NRHP Evaluation and in the DPR 523 forms included in Appendix B. Please note, the Survey Population includes select resources that have multiple functionally and physically related

components that were documented as a single related multi-component property, as discussed in Section 4 and Appendix B.

Table CUL 5-1 Historic Period Built Environment Survey Population

Resource Name	Construction Date	Previous NRHP Evaluation OHP Status Codes
Kaweah No. 1 Facilities		
Kaweah No. 1 Powerhouse and Penstock	1898; 1928-1929	6Y (Determined ineligible for NRHP by consensus through Section 106 process, not evaluated for CRHR or local listing.)
Kaweah No. 1 Diversion Dam	1898; 1940	6Y
Kaweah No. 1 Flowline	1947 (reconstruction from original 1899 flowline)	6Y
Kaweah No. 1 Forebay Tank	1947 (reconstruction from original 1899 forebay)	6Y
Kaweah No. 1 Powerhouse Campus	1927; circa 1950; 1990	6Y
Mineral King Dams	1903-1905	6Y
Kaweah No. 2 Facilities		
Kaweah No. 2 Powerhouse and Penstock	1905	6Y
Kaweah No. 2 Diversion Dam	1905; 1938; 2012-2013	6Y
Kaweah No. 2 Flowline	1905; 1948; 1984	6Y
Kaweah No. 2 Forebay	1905; 1946	6Y
Kaweah No. 3 Facilities		
Kaweah No. 3 Powerhouse and Penstock	1913	2D2; 2S2 (2D2: Contributor to a District determined eligible for the NRHP by consensus through Section 106 process, listed in the CRHR; 2S2: Individual property determined eligible for the NRHP by consensus through Section 106 process, listed in the CRHR)
Marble Fork Diversion Dam	1913	6Y
Marble Fork Flowline and Siphon	1913	2D2
Middle Fork Diversion Dam	1913	6Y
Middle Fork / Kaweah No. 3 Flowline	1913; 1946	2D2
Kaweah No. 3 Forebay	1913; 2012	2D2
Project Support Facilities		
Kaweah Hydroelectric Project Stream Gages	1952-2005	Unevaluated
Kaweah Transmission Lines: <ul style="list-style-type: none"> • Kaweah No. 3 Powerhouse to Three Rivers Substation • Kaweah No. 1 Tap Line 	1913; replacement ongoing with most recent transmission structures added circa 2012	Unevaluated

Resource Name	Construction Date	Previous NRHP Evaluation OHP Status Codes
Kaweah No. 1 Facilities		
<ul style="list-style-type: none"> • Kaweah No. 2 Tap Line • Kaweah Distribution and Fiber Lines 		

Note: Refer to California OHP Reply: FERC890210A for formal SHPO concurrence regarding eligibility of all resources in the built environment Survey Population. All California Historical Resource Status Codes taken from Tulare County Historic Properties Data File (HPD), 04-05-2012.

5.2 Records Research

All records pertaining to the Survey Population held on file at the SJVIC, the BLM, and at SCE were formally reviewed as part of this study. The records research revealed that the majority of built environment resources located within the Project APE and SNP Study Area had been subject to previous documentation in 1989 as part of the previous relicensing effort. As part of this previous documentation effort, the majority of facilities associated with the Kaweah Hydroelectric Project were documented in a comprehensive single report: *A History and Significance Evaluation of the Kaweah Hydroelectric System, Tulare County, California*, authored by Lehman et al. (Appendix C).

The analysis conducted for the 1989 report determined that built environment features associated with the Kaweah No. 1 and Kaweah No. 2 developments appeared ineligible for listing in the NRHP due to a lack of integrity as defined by the seven aspects of integrity, precluding the resources' ability to convey significance. However, the analysis found that select components of the Kaweah No. 3 development appeared eligible for listing in the NRHP as contributors to a Kaweah No. 3 Hydroelectric System Historic District under Criteria A and C because of their pioneering hydroelectric design and their associations with the development of hydroelectric capacity for agricultural pump irrigation. These eligible components include: Kaweah No. 3 Powerhouse; Marble Fork Flowline and Siphon; Middle Fork Flowline / Kaweah No. 3 Flowline; and the Kaweah No. 3 Forebay. The remaining Kaweah No. 3 facilities, including the Middle Fork and Marble Fork Diversion Dams, were found ineligible because of a lack of integrity to the original design. SHPO concurred with all findings of this analysis in a letter dated March 21, 1990 (Reference: FERC890210A).

While the previous 1989 documentation analyzed most built environment components of the Kaweah Hydroelectric Project, the documentation did not formally inventory several support facilities, including associated transmission lines and Project Stream Gages. As such, these components of the Survey Population have no formal previous evaluation status, as documented in Table CUL 5-1.

5.3 Historical Context for Development

5.3.1 Contextual Overview

The 1989 *History and Significance Evaluation of the Kaweah Hydroelectric System* presented a comprehensive portrait of the development and operations of the Kaweah Hydroelectric Project, documenting the establishment of the Project by Mount Whitney Power Company as well as providing a contextual narrative of continued Project developments under SCE. This previous report is included in Appendix C for reference and provides a wealth of detailed information regarding development of the Kaweah Hydroelectric Project.

This updated historical development context summarizes the primary development narrative established by the previous 1989 inventory and evaluation, and presents additional analysis and contextual information to inform the updated inventory and NRHP evaluation. The updated analysis provides

additional contextual material regarding the broad development themes of hydroelectric expansion in late nineteenth and early twentieth century California, to augment the previous analysis. This additional material serves to situate the Kaweah Hydroelectric Project within the larger context of hydroelectric development across the state in order to determine the system's ability to convey significant themes of development under the NRHP.

5.3.2 Growth of Hydroelectric Capacity in California

By the closing decades of the nineteenth century, the development and consumption of electricity had come to define the possibilities of modernity for both California and the nation. Ushering in a host of modern marvels, including widespread civic and residential lighting, public transportation, industrial and agricultural development, and a radically altered commercial and domestic sphere, the advent of electricity became a singular fixation, transforming the lives of millions in mere decades. In its initial years of popular advancement, however, the nascent industry was defined as much by its constraints as its possibilities, with seemingly intractable physical and technological barriers preventing widespread development and public adoption of electricity. Overcoming these barriers to mass production and consumption became the central theme of early electrical expansion, with engineers, financiers, and an engrossed public marking every advancement with fanfare, pomp, and a seemingly universal conviction of electricity's ultimate transformative power.⁵

In large, California's nineteenth century electrical industry was hampered by two primary material deficiencies, with the first stemming from a paucity of readily exploited fuels. While areas of the state boasted abundant forests, much of the state was devoid of extensive tree cover. In addition, the state lacked critical coal deposits and other readily utilized natural resources, with oil exploration still in relative infancy. As a result, early electrical generation schemes were limited in both scalability and reach, with only isolated, if high profile, municipal success stories involving gas, coal, wood, and other traditional fuel sources.⁶

Although California failed in these measures of material abundance, the state's nascent electrical industry soon turned to the vast untapped potential of a seemingly limitless resource of mountain water. In particular, the waters that thundered down the steep flanks of the Sierra Nevada. Unlike the largely flat rivers of the East and Midwest, the rivers of the Sierra Nevada were characterized by widely disseminated watersheds with astonishingly steep descents, with a snowpack that continuously relayed flows to the valleys below via an intricate network of abundant rivers and streams. Within this geographic context, the system presented ideal generation conditions, which required sharp drops and sustained flows to produce hydroelectric power.⁷

In many senses, the commercial exploitation of hydro power was not wholly new, and owed much to California's intensive mining era. Primitive hydroelectric systems had emerged from California's mining industry as early as the 1870s, with a number of mines producing sufficient supplies for private use, thereby increasing efficiencies and yield. In addition, the commercial expansion of the hydroelectric industry was founded upon basic mining principles that had been in use for decades, including tunnel driving and hydraulic engineering. The profound shift that vaulted commercial hydroelectric development to the forefront of electrical advancement, however, related to the solution of the state's second material constraint: the development of effective transmission methods over large-scale distances.⁸

⁵ Joseph Wetzler, "The Electric Railway of Today," *Scribner's Magazine*, April 1890, 7; James C. Williams, *Energy and the Making of Modern California* (Akron, OH: The University of Akron Press, 1997), 168-236; *The Telegraphic Journal and Electrical Review*, "Electricity in the United States," July 4, 1885, 13.

⁶ James C. Williams, *Energy and the Making of Modern California*, 168-236.

⁷ James C. Williams, *Energy and the Making of Modern California*, 168-236; James C. Williams, "California's First High Head Turbine Installation," *The Journal of the Society for Industrial Archaeology*, Vol. 22, No. 1, 1996.

⁸ James C. Williams, *Energy and the Making of Modern California*, 168-236; James C. Williams, "California's First High Head Turbine Installation," *The Journal of the Society for Industrial Archaeology*, Vol. 22, No. 1, 1996.

While the towering wall of the Sierra had long been known to present lucrative opportunities for hydro-generation, the great distances separating the mountains from the state's major coastal population centers had always precluded viable statewide development. As late as the 1880s, effective transmission was largely limited to an approximately 10-mile sphere, with available direct current (DC) technologies precluding reliable service delivery outside of an exceedingly limited radius. Solving the transmission puzzle became the defining electrical pursuit of the late nineteenth century, leading to the revolutionary adoption of alternating current (AC) systems, which phased and stepped power along the transmission corridor to conserve and maintain voltage levels. AC experimentation began in Europe in the 1870s, and by the 1890s had proved to be vastly superior to DC current.⁹

By the early 1890s, three-phase AC electrical transmission had been implemented at a number of early hydroelectric plants in California, including Redlands Electric Light and Power Company's Mill Creek Power Plant, the Sacramento Electric Power and Light Company's Folsom Powerhouse, and the San Joaquin Electric Company's Powerhouse No. 1 on the San Joaquin River. At Mill Creek, AC transmission sent 2,400 volts of power 7.5 miles to the City of Redlands; at Folsom, 2 years later, transmission length had jumped to 22 miles, with an output of 11,000 volts; the same year, the San Joaquin Powerhouse sent 11,000 volts 37 miles to Fresno. While these distances and voltages seem modest in scale related to modern applications, they proved revolutionary in establishing the commercial viability of AC hydroelectric generation in California. By 1895, the burgeoning long-distance hydroelectric industry was central to California's conception of future growth, with the *San Francisco Call* summarizing the phenomenon:

A new kind of hustler has arisen within the past three or four months, he has been rapidly multiplying and filling the earth. He is the promoter of new electrical enterprises, and especially the promoter of schemes for the long-distance transmission of electric power. The air of the whole Pacific Coast has all at once been filled with talk about setting up water wheels in lonely mountain places and making them give light and cheaply turn other wheels in towns miles away.¹⁰

Thus, by 1900, hydroelectricity had become one of the central tenets of California's physical growth and economic expansion. As chronicled by James C. Williams, a central historian of the development of energy in California, "before the mid-twentieth century, electric power in California meant hydroelectricity," with energy development and hydroelectric expansion virtually synonymous. With the ready abundance of ideal natural watersheds coupled with the radical strides in AC transmission technology, the state became an ideal proving ground for advancements in the industry, with both engineers and investors flocking to the rapidly evolving arena.¹¹

By the 1910s, California led the nation in hydroelectric development, with a number of previously unimaginable mega-projects powering the rapidly growing urban sphere and shaping the Sierra. The projects spanned the state, with major facilities developed in Southern California, most notably Pacific Light and Power Company's gargantuan Big Creek, as well as the northern reaches of the state, including Pacific Gas and Electric Company's (PG&E) Pit River Development in Shasta County as well as a host of developments proposed or planned along Northern California's more abundant mountain waterways. The projects, located in far-flung and little developed mountain areas, utilized the suite of technological principles that had been rapidly perfected over the previous decades, including increasingly efficient turbines, massive improved generators and electrical governing equipment, and, perhaps most critically, newly perfected long-distance transmission technologies. By the early 1920s this widespread technological and physical development had transformed community and economic life across the state and the nation. A 1921 lecture of the San Francisco Electrical Development League succinctly conveyed

⁹ Thomas P. Hughes, *Networks of Power: Electrification in Western Society: 1880-1930* (Baltimore: Johns Hopkins University Press, 1983), 278-280; Thomas P. Hughes, "An Incident in the AC-DC Controversy," *The Business History Review*, Vol. 32, No. 2, Summer 1958.

¹⁰ Darrell W. Heinrich, "Mill Creek No. 1: Pioneering Commercial Electric Power," *Hydro Review*, October 2002; *San Francisco Call* Article quoted in *Energy and the Making of Modern California*, 177.

¹¹ James C. Williams, *Energy and the Making of Modern California*, 168-236; *Journal of Electricity*, "Applying the Self-Interest Story," Volume 46, No. 1, January 1, 1921.

this radically altered sphere, opining on the centrality of electricity, “Of all the agencies that contribute to the comforts and conveniences of this twentieth century civilization, electricity is undoubtedly the greatest. It enters into nearly every phase of our domestic and business life: transportation, communication, food production and preparation, light, heat, and the production of all of our necessities and luxuries.”¹²

5.3.3 Mount Whitney Power Company: Hydroelectricity and Agricultural Development

Within this context of rapid hydroelectric expansion, the Mount Whitney Power Company emerged as an early electrical innovator in Tulare County, establishing one of the state’s earliest three-phase AC hydroelectric plants on the Kaweah River in the mountains east of Visalia. The hydroelectric project was the brainchild of Ben Maddox, a Tulare County booster who was editor of the Visalia Times and a substantial agricultural landowner, farming 600 acres of plums north of Visalia. Observing the spate of hydroelectric advances that characterized the 1880s and 1890s, Maddox theorized that hydroelectric development could transform Tulare County’s arid dry-farmed lands into a verdant agricultural enclave, allowing farmers to efficiently access a deep wellspring of ground water through pump irrigation and free themselves from the punishing Mediterranean climate cycle. Maddox was well situated to realize his goal, having both a vocal editorial platform in the Visalia Times from which to tout the virtues of electrical irrigation and a cadre of associates who were well versed in the technical and economic development of hydroelectric schemes. By the mid-1890s Maddox was in partnership with William Henry Hammond, a Tulare County Clerk and real estate promoter, and Albert G. Wishon, a fellow real estate promoter with a

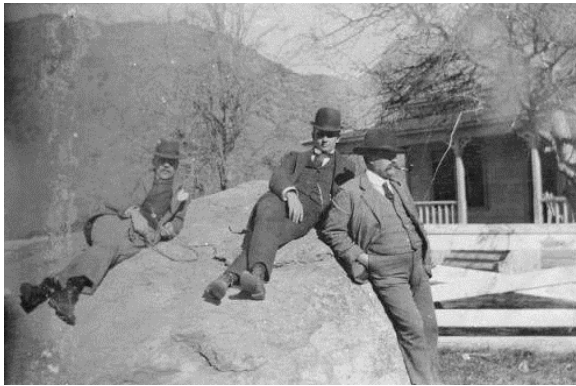

Courtesy of the Huntington Digital Library, Southern California Edison Company Photograph Collection, Call Number 04 - 00716

Figure CUL 5-1 Founders of Mount Whitney Power Company, Hammond, Maddox, Wishon (l-r), ca. 1908

particular interest in and affinity for agricultural irrigation schemes (Figure CUL 5-1). Initially, the three formed the Kaweah Electric Light and Power Company, securing financing and rights-of-way to develop a hydro plant at the present site of Terminus Dam below Three Rivers. Ultimately this plan was scrapped; however, as Wishon studied the rapid technological advances of the period and realized the full possibility of high head hydroelectric development further up the Kaweah River. By 1898 the group had reorganized as the Mount Whitney Power Company and construction had begun on the company’s first powerhouse in Three Rivers, Kaweah Powerhouse No. 1. Funding for the venture was supplied by William Henry Hammond’s brother, John Hays, a London-based mining magnate who joined the three founders as a key financier for the duration of Project development.¹³

Mount Whitney Power Company was notable in that the company’s exclusive focus on agriculture departed markedly from the hydroelectric business model pursued to date. The state’s earliest plants, most notably Redlands, Folsom, and San Joaquin, oriented to California’s burgeoning cities, supplying electricity for urban lights, streetcars, industry, and a growing array of personal urban consumption. By recognizing and capitalizing on the tremendous market potential of irrigated agriculture, Mount Whitney laid the foundation for a comprehensive campaign of rural and agricultural electrification that characterized the first decades of the twentieth century in California, a campaign that ultimately served to create the intensive irrigated agricultural landscape that defines the state to the present. As recorded in a *Journal of Electricity*

¹² *Journal of Electricity*, “Applying the Self-Interest Story,” Volume 46, No. 1, January 1, 1921.

¹³ Earl A. McKee, Jr., Gaynor B. McKee, and Carol Nadine McGrew, *Echoes of Three Rivers: Landmarks and Lore* (Spokane, WA: Kaweah Echoes Press, 2017), 71-83; “Hydroelectric Power Development and Transmission in California,” *Association of Engineering Societies*, Vol. XXXIV, No. 3, March 1905, 8-98.

retrospective of the Project in 1913, “The idea of pumping the underground waters for irrigation was a conception originating with this Project. Nowhere else had such a plan been considered feasible.”¹⁴

By the 1890s, California farmers and real estate promoters were well acquainted with the intractable geographic conundrum that limited the state’s potential. On the one hand, California boasted a premier growing season and climate that allowed for production of virtually any crop. On the other, the state’s climate regime was characterized by penetrating summers with no rain and spiking temperatures—a pattern which precluded extensive cultivation in many sections of the state. Period agricultural publications expressed settler’s frustration—and even dread, as in an 1899 *Pacific Rural Press* article which lamented, “We are well out of the rainy months and well into the long, dry season. The heat is rising; the sun takes a longer, steadier gaze at our place on the earth’s surface; occasional puffs of hot, dry wind give a foretaste of what soon will be for months to come.” Within this context, successful delivery of water was the key to unwrapping both agricultural plenty and economic growth—as vast tracts of arid land could be transformed to marketable agricultural property. As concluded by the *Journal of Electricity, Power, and Gas*, “The east half of the San Joaquin Valley of Central California is a vast plain of tillable, productive land, whose potential value manifests itself in the prolific outpourings of its hidden resources only by the application of a constant supply of water...unlocking this has remained for the magic power of electricity to make possible the modern reality of quenching the thirst of this otherwise favored area.”¹⁵

Mount Whitney’s pioneering efforts in electrical irrigation provided an early model for the transformative impact of pump irrigation—providing electricity to large sections of Tulare County and allowing for extensive agricultural expansion and diversification. By the early years of the twentieth century, other electrical concerns followed suite, with virtually all of the state’s nascent electrical companies accessing the agricultural market. In large, this market served as a complement to the steady electrical expansion in the urban realm, with secondary transmission and distribution lines emanating from the major trunk transmission corridors that connected cities such as Los Angeles and San Francisco. By 1909, over 2 million acres of California agricultural land were irrigated. By 1930 this number had risen 2 over 5 million, a number which has continued to expand to the present. By 1920, the total agricultural load of California’s leading electrical companies was reported at nearly 300 MW, almost entirely from California’s hydro systems. This massive increase was largely predicated on the steady expansion of electrical infrastructure, coupled with a drumbeat of marketing and advertising that saturated the state’s agricultural press and real estate marketing channels (Figure CUL 5-2). With the water problem seemingly solved, California was marketed as a veritable Eden—with a mild climate, rich soils, and abundant water supplies that overcame all of the state’s earlier climatic limitations.¹⁷

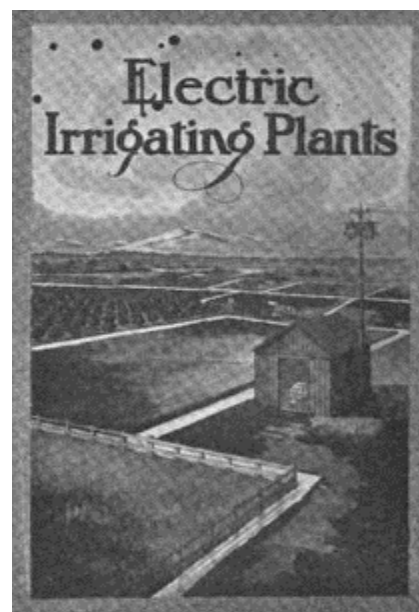

Figure CUL 5-2 Promotional Power Brochure, 1920¹⁶

¹⁴ “Hydroelectric Power Development and Transmission in California,” *Association of Engineering Societies*, Vol. XXXIV, No. 3, March 1905, 8-98; James C. Williams, *Energy and the Making of Modern California*, 218-236; System of the Mount Whitney Power and Electric Company,” *Journal of Electricity, Power, and Gas*, Vol. XXXI, No. 26, December 27, 1913.

¹⁵ “Cultivation and Irrigation,” *Pacific Rural Press*, May 13, 1899; “Use of Electricity for Irrigation on the Farm,” *Journal of Electricity, Power, and Gas*, June 29, 1912; “System of the Mount Whitney Power and Electric Company,” *Journal of Electricity, Power, and Gas*, Vol. XXXI, No. 26, December 27, 1913.

¹⁶ Graphic published in *Journal of Electricity*, Vol. 45, November 15, 1920, 459.

¹⁷ “System of the Mount Whitney Power and Electric Company,” *Journal of Electricity, Power, and Gas*, Vol. XXXI, No. 26, December 27, 1913.

5.3.4 Physical Development of the Kaweah System

This section provides an overview of the physical development of the Kaweah River system, followed by a detailed discussion of ongoing operations and alterations to the system through the present. The 1989 *History and Significance Evaluation of the Kaweah Hydroelectric System* included in Appendix C provides an extensive detailed narrative of the development of the Kaweah River System from 1899, with the completion of Powerhouse No. 1, to 1920, when the holdings of Mount Whitney Power Company were officially absorbed by SCE.

5.3.4.1 Kaweah No. 1 Development

After securing water rights and rights-of-way between 1896 and 1898, the Kaweah No. 1 Powerhouse and its associated hydroelectric infrastructure were developed in 9 months, with construction beginning in October of 1898 and the plant coming on-line in June of 1899. System components included the powerhouse; a diversion dam on the East Fork of the Kaweah River; an approximately 30,000-foot-long redwood flume conveying water from the diversion to the penstock; and a 3,300-foot-long penstock with a vertical head of 1,300 feet—one of the highest developed to date. Mount Whitney Power Company retained San Francisco Engineer Robert McF. Doble to design all system components. Doble was associated with the San Francisco Abner Doble Company, a family concern that had staked a major claim in the burgeoning hydroelectric development market with their development of improved elliptical water turbines that reduced inefficiencies and problematic bucket wear of the standard Pelton Wheel.¹⁹

As described by period press, the Kaweah Powerhouse No. 1 was a, “plain but substantial structure,” measuring 30 feet by 50 feet and 20 feet in height. The building was rectangular in plan and was constructed of Oregon pine sheathed in corrugated iron. The spare and utilitarian design was generally reflective of California’s nineteenth century hydro plants, which were limited in their ornamentation and architectural treatment (Figure CUL 5-3).²⁰

As designed, the powerhouse had a capacity of 2,000 horsepower (hp) and was noted for its, “compact and logical arrangement,” containing three Doble Tangential water wheels, three Westinghouse Kodak type three-phase AC generators, and four Westinghouse oil insulated air cooled transformers which stepped up power from 440 volts to 17,300 volts for transmission (Figure CUL 5-4). The transmission system included 42 miles of redwood pole line to Porterville, and 41 miles to Tulare—with substations in Visalia, Tulare, Exeter, Lindsay, and Porterville. The powerhouse’s penstock was fabricated and laid by the Lacy Manufacturing Company of Los Angeles and descended approximately 1,300 feet from the terminus of the flume on the steep canyon above the powerhouse. The



Courtesy of the Huntington Digital Library, SCE Photograph Collection, Call Number 04 - 00041

Figure CUL 5-3 Kaweah Powerhouse No. 1, 1904

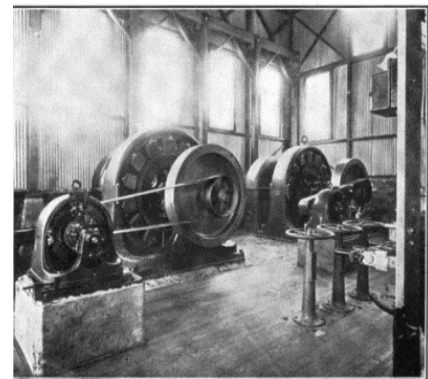

Figure CUL 5-4 Interior of Powerhouse No. 1, circa 1900¹⁸

¹⁸ “Hydroelectric Power Development and Transmission in California,” *Association of Engineering Societies*, Vol. XXXIV, No. 3, March 1905, 86.

¹⁹ B.J. Lewis, J.M. Cimbala, A.M. Wouden, “Major Historical Developments in the Design of Water Wheels and Francis Hydroturbines,” paper presented at the IOP Conference Series: Earth and Environmental Science. Accessed online, September 11, 2018, <http://iopscience.iop.org/article/10.1088/1755-1315/22/1/012020/pdf>; “The Mount Whitney Water Power Electric Plant and Light Regulating Device,” *Engineering News*, Vol. XLII, No. 10, September 7, 1899, 151

²⁰ “System of the Mount Whitney Power and Electric Company,” *Journal of Electricity, Power, and Gas*, Vol. XXXI, No. 26, December 27, 1913.

penstock was constructed with riveted steel and trenched for the bulk of the alignment, with a starting diameter of 50 inches, tapering to approximately 20 inches at the powerhouse.²¹

Water for the powerhouse was diverted from the East Fork of the Kaweah River, with a small masonry diversion dam constructed approximately 5 miles above the confluence of the East and Middle Forks of the Kaweah River. The simple dam conveyed water into a 47-foot-long drilled rock tunnel and subsequently to the redwood flume below (Figures CUL 5-5 and 5-6). As described by Project engineers, “The diversion dam was located at the outlet of a natural basin where a small granite masonry dam maintains the water level for the intake to the conduit. The tunnel runs through a jutting rock spur, delivering the water from this basin to a timber flume, which follows the very precipitous mountain side of the south slope of the canyon.”²²



Courtesy of the Huntington Digital Library, Southern California Edison Company Photograph Collection, Call Number 04 - 00043

Figure CUL 5-5 Kaweah No. 1 Diversion Dam, 1904



Courtesy of the Huntington Digital Library, Southern California Edison Company Photograph Collection, Call Number 04 - 00720

Figure CUL 5-6 Overview of Kaweah No. 1 Diversion Dam with Catwalk leading to Flume (l-r), 1908

The Kaweah No. 1 flume was constructed of redwood and followed the south bank of the river canyon, running for 30,723 feet, or 6 miles, to its terminus above the powerhouse. The flume, “followed the common practices in California at the time it was built,” and was 3 feet wide in section and 2 feet deep. The flume body was supported by redwood posts, which varied in height depending on ground contour, ranging from heights of 6 to 50 feet. The capacity of the flume was 17 cubic feet per second (Figures CUL 5-7 and 5-8).

²¹ “Hydroelectric Power Development and Transmission in California, “*Association of Engineering Societies*, Vol. XXXIV, No. 3, March 1905, 80-90; “The Mount Whitney Water Power Electric Plant and Light Regulating Device,” *Engineering News*, Vol. XLII, No. 10, September 7, 1899, 151; “System of the Mount Whitney Power and Electric Company,” *Journal of Electricity, Power, and Gas*, Vol. XXXI, No. 26, December 27, 1913.

²² “System of the Mount Whitney Power and Electric Company,” *Journal of Electricity, Power, and Gas*, Vol. XXXI, No. 26, December 27, 1913.



Courtesy of the Huntington Digital Library, Southern California Edison Company Photograph Collection, Call Number 04 - 00721

Figure CUL 5-7 Representative Trestle Section of Kaweah No. 1 Flume, circa 1908



Courtesy of the Huntington Digital Library, Southern California Edison Company Photograph Collection, Call Number 04 - 00724

Figure CUL 5-8 Kaweah No. 1 Flume at Powerhouse No. 1 Penstock, circa 1908

Upon completion of the initial Kaweah development, Maddox's *Visalia Times* proclaimed, "The long-distance electric plant which begins today to furnish power will make the wheels of manufacturing establishments turn, irrigating plants multiply, and darkness light." Despite this proclamation, securing the Tulare County load for the system was a somewhat protracted endeavor, with initial consumption limited. Although the intended consumers were primarily farmers, many were reticent to purchase the required pumps and equipment. As such, during the first years of operation, growth was somewhat slow, with approximately 700 hp of the available 2,000 utilized. Additionally, the earliest contracts were generally non-agricultural in nature, with service extending to commercial concerns including the county's ice plants, hotels, newspapers, and other commercial entities. Recognizing the need for incentives and demonstrating a strong acuity for marketing, Albert Wishon ultimately secured funds to purchase pumps himself, offering them to farmers on credit. With this substantial buy-in hurdle cleared, adoption rates climbed. By 1903 Mount Whitney Power Company had 710 subscribers, primarily agricultural—a number which soared to thousands in the span of a decade.²³

Even as Mount Whitney Power Company continued to expand as a major force for development of Tulare County, quarrels over the company's scope of development ultimately led to the defection of founding partner Albert Wishon. While Wishon had a grand view of development which encompassed virtually all of the major watersheds of central California, Hammond and Maddox were more regional in focus, with a smaller lens that only included more modest developments in Tulare County. In 1902, Wishon left the company, forming San Joaquin Light and Power Company in Fresno with a cadre of business partners. At San Joaquin Light and Power Company, Wishon continued his emphasis on agricultural irrigation, creating a formidable rival in the Central California region.²⁴

5.3.4.2 Kaweah No. 2 Development

As consumer adoption climbed, Mount Whitney Power Company turned to expansion of the system, with planning and construction of a second powerhouse initiated in the first years of the twentieth century. By 1904, Powerhouse No. 2 was under construction, located across the Kaweah River from Powerhouse No. 1, approximately 1 mile downstream. In contrast to most California hydroelectric plants constructed at the time and to the present, the powerhouse was considered a "low-head" installation, fed by a small penstock with static head of only 351 feet. Associated system components included a diversion dam on the Kaweah River, approximately 1 mile above its confluence with the East Fork; an approximately 4-mile-long canal extending to the powerhouse, of which most was concrete-lined ditch with some components timber flume; a small regulating forebay; and the 1,000-foot penstock leading to the powerhouse.²⁵

The company used a utilitarian design similar to the Kaweah No. 1 Powerhouse, with a rectangular-plan building of wood-frame construction and corrugated iron sheathing (Figure CUL 5-9). The building measured approximately 30 feet by 50 feet and was initially developed with three General Electric generating units and Victor Girard Type Turbine, each with a capacity of 500 kilowatts (kW) (Figure CUL 5-10). Within several years, two of these units were removed and replaced with a single 1,500 kW General Electric Generator attached to a Francis-type turbine. Seven transformers were housed in a concrete extension attached to the powerhouse, with a transmission voltage of 35,000 volts.²⁶

²³ *Visalia Times*, "Kaweah Hydroelectric Development," June 29, 1899; "System of the Mount Whitney Power and Electric Company," *Journal of Electricity, Power, and Gas*, Vol. XXXI, No. 26, December 27, 1913.

²⁴ Earl A. McKee, Jr., Gaynor B. McKee, and Carol Nadine McGrew, *Echoes of Three Rivers: Landmarks and Lore*, 71-83; James C. Williams, *Energy and the Making of Modern California*, 180-224; William A. Meyers, *Iron Men and Copper Wires, A Centennial History of the Southern California Edison Company* (Glendale, CA: Trans-Anglo Books, 1947, 86-91.

²⁵ "System of the Mount Whitney Power and Electric Company," *Journal of Electricity, Power, and Gas*, Vol. XXXI, No. 26, December 27, 1913.

²⁶ "System of the Mount Whitney Power and Electric Company," *Journal of Electricity, Power, and Gas*, Vol. XXXI, No. 26, December 27, 1913.



Courtesy of the Huntington Digital Library, Southern California Edison Company Photograph Collection, Call Number 04 - 00069

Figure CUL 5-9 Kaweah No. 2 Powerhouse, 1904

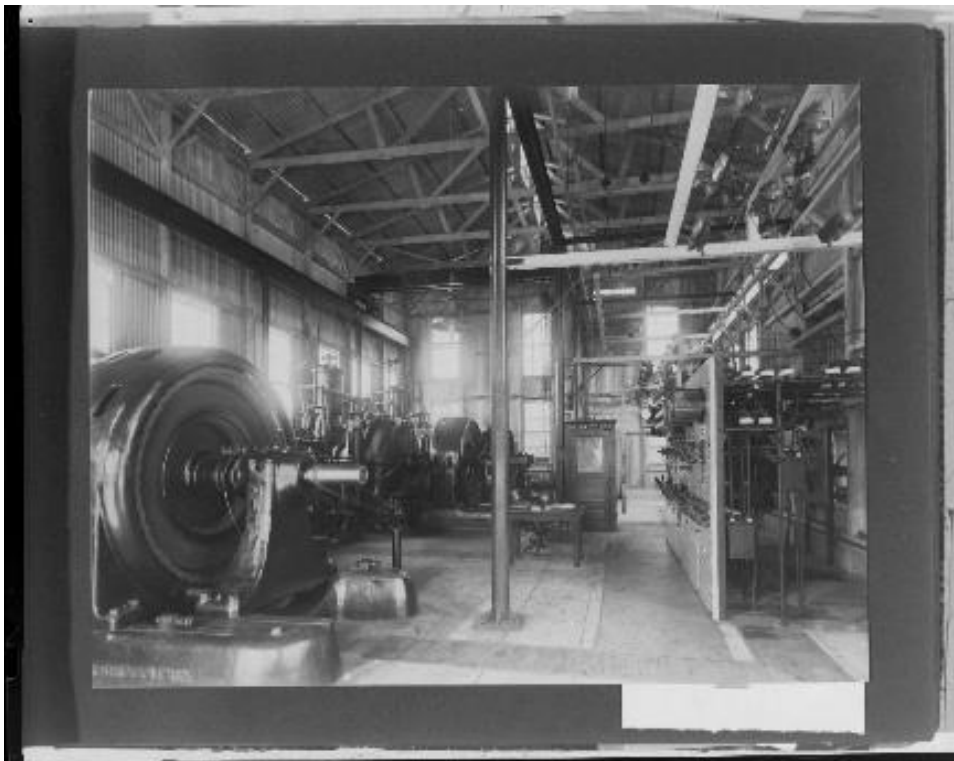

Courtesy of the Huntington Digital Library, Southern California Edison Company Photograph Collection, Call Number 04 - 00735

Figure CUL 5-10 Interior of Powerhouse No. 2, circa 1908

The Kaweah No. 2 Diversion paralleled that of Kaweah No. 1 Diversion in design, in that the dam was of a low-form granite masonry construction that utilized the natural curvature of the river's flanking ledges (Figure CUL 5-11). The maximum height of the dam was 8 feet. Four hand operated sluice gates controlled flow into the canal. Slightly over 3 miles of the canal was concrete-lined ditch, with 0.75 mile of timber flume where conditions precluded ditching (Figure CUL 5-12). The Kaweah No. 2 Forebay was modest in scale, with a length of 270 feet, a width of 12 feet, and a depth of 9 feet (Figure CUL 5-13). From the forebay, the penstock extended 1,000 feet to the turbines of Powerhouse No. 2 below.



Courtesy of the Huntington Digital Library, Southern California Edison Company Photograph Collection, Call Number 04 - 00034

Figure CUL 5-11 Kaweah No. 2 Diversion, 1908



Courtesy of the Huntington Digital Library, Southern California Edison Company Photograph Collection, 04 - 00732

Figure CUL 5-12 Kaweah No. 2 Concrete Ditch and Flume Section, circa 1908



Courtesy of the Huntington Digital Library, Southern California Edison Company Photograph Collection, Call Number 04 - 00071

Figure CUL 5-13 Kaweah No. 2 Forebay, 1908

As Mount Whitney Power Company added capacity with the development of Powerhouse No. 2, they also sought to stabilize flow for the Kaweah No. 1 development. The company's studies indicated that the geologic and geographic setting of the Kaweah System precluded the siting of large reservoirs, with the system largely dependent on run-of-the-river flows. While flows were deemed adequate much of the year, the late season cessation of flows coincided with the time of heightened demand for agricultural irrigation, thus stressing the system supply. To supplement flows, Mount Whitney Power Company incorporated several natural high Sierra lakes into the system. Termed the Mineral King Lakes, the small reservoirs included Lady Franklin Lake, Silver (Crystal) Lake, Eagle Lake, and Monarch Lake. The small lakes were damned with low masonry dams between 1903 and 1905 and served to modestly augment flows along the East Fork of the Kaweah River and in turn Kaweah Powerhouse No. 1, adding 1,153 acre feet of storage to the system (Figure CUL 5-14).²⁷ Note that the Mineral Kings Lakes are located within the boundaries of the SNP and are therefore not included in the FERC license.



Courtesy of the Huntington Digital Library, Southern California Edison Company Photograph Collection, Call Number 02 - 30795

Figure CUL 5-14 Monarch Lake Masonry Section, 1951

5.3.4.3 Kaweah No. 3

As more farmers adopted pump irrigation, expanded cultivated acreage, and diversified their holdings, even the additional generation provided by the Kaweah No. 2 development quickly proved inadequate to meet demand. A company graphic from the period demonstrates the steady growth curve, with yearly demand threatening to outstrip generation output (Figure CUL 5-15). By 1906, Mount Whitney Power Company had applied for permits to construct a third power plant, Kaweah No. 3, which would divert water from the Marble and Middle Forks of the Kaweah River. System components included the powerhouse, two diversion dams, and a Y-shaped flowline and siphon that traversed approximately 7 miles of rugged terrain. Permitting was

²⁷ "System of the Mount Whitney Power and Electric Company," *Journal of Electricity, Power, and Gas*, Vol. XXXI, No. 26, December 27, 1913; Earl A. McKee, Jr., Gaynor B. McKee, and Carol Nadine McGrew, *Echoes of Three Rivers: Landmarks and Lore*, 71-83.

complicated by the fact that portions of the proposed project were located within the boundary of the newly established SNP, including both diversions and much of the flowline. Thus, Mount Whitney Power Company applied for permits from both the Secretary of the Interior and Secretary of Agriculture, accounting for the flanking jurisdictions of the SNP and Sierra National Forest (SNF). The company received a permit from the Secretary of the Interior in 1907, with a temporary permit from the Secretary of Agriculture in 1909; this permit was superseded by a permit issued by the Federal Power Commission in 1924, the antecedent of the current FERC.²⁸

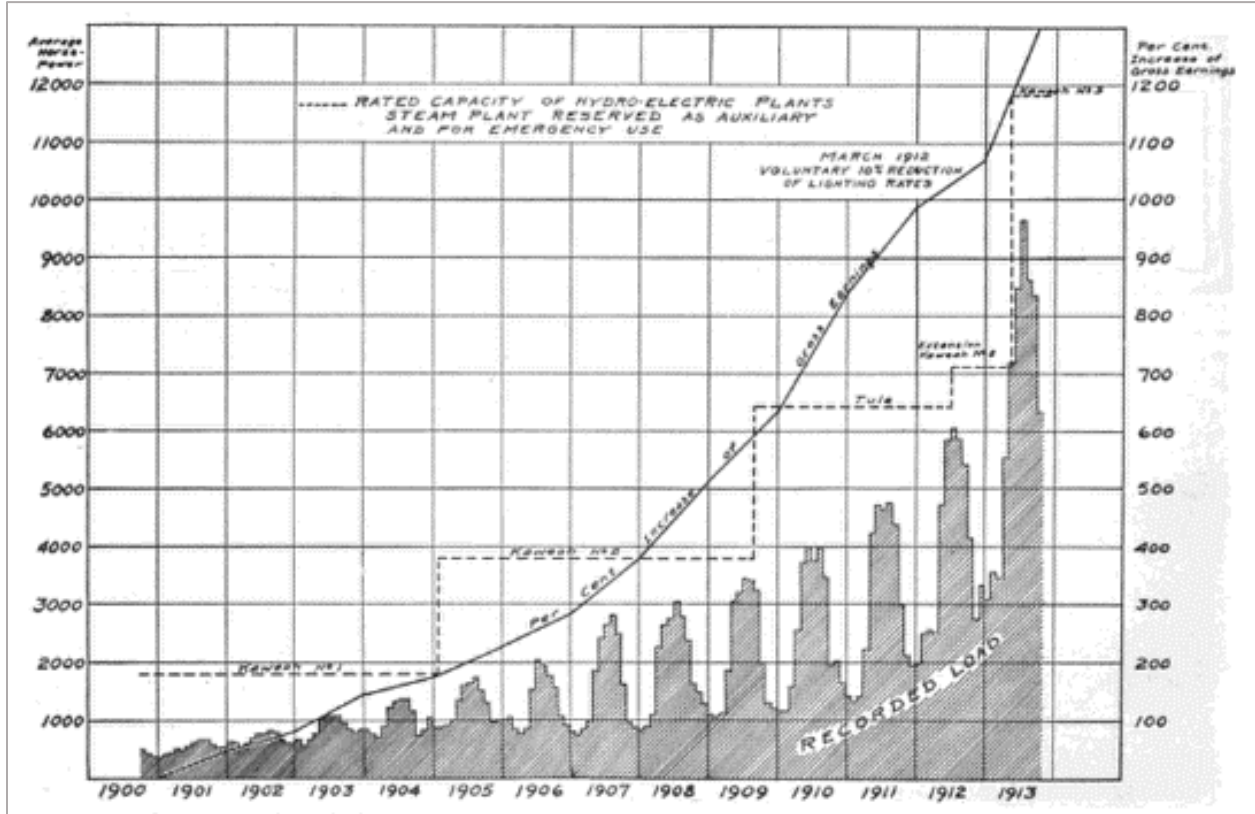

Figure CUL 5-15 Mount Whitney Power Company Demand Graph, 1913²⁹

In contrast to the utilitarian corrugated metal design of the system’s first two powerhouses, Kaweah Powerhouse No. 3 was of a far more substantial reinforced concrete design, measuring 50 feet by 50 feet and reflective of a heightened yet spare classical design sensibility (Figure CUL 5-16). The design was reflective of both the company’s stature as a major regional utility and the overall tone of monumental design that came to characterize powerhouse construction in the 1910s and 1920s. In contrast to the earliest plants, which were often designed with little attention to architectural allusion, the plants of the early twentieth century took on an increasingly monumental tone, as utility companies sought to convey the stature of the industry through architectural form.

²⁸ Earl A. McKee, Jr., Gaynor B. McKee, and Carol Nadine McGrew, *Echoes of Three Rivers: Landmarks and Lore*, 71-83; James C. Williams, *Energy and the Making of Modern California*, 180-224; William A. Meyers, *Iron Men and Copper Wires, A Centennial History of the Southern California Edison Company* (Glendale, CA: Trans-Anglo Books, 1947, 86-91.

²⁹ “System of the Mount Whitney Power and Electric Company,” *Journal of Electricity, Power, and Gas*, Vol. XXXI, No. 26, December 27, 1913.



Courtesy of the Huntington Digital Library, Southern California Edison Company Photograph Collection, Call Number 02 - 06179

Figure CUL 5-16 Kaweah No. 3 Powerhouse, 1920

The powerhouse was situated directly above the diversion intake for the Kaweah No. 2 Powerhouse, so that outflow from Powerhouse No. 3 fed directly to the diversion. The interior of the powerhouse was characterized by a main generating room floor with two Westinghouse generators, with a transverse interior partition separating the generating facilities from the four transformers and high tension bus. The three-phase generators were rated at 2,300 volts. The two single-jet single-overhung turbines were of the Pelton-Doble design and were supplied by the Pelton Water Wheel Company (Figure CUL 5-17). Power from the plant was transmitted at 35,000 volts, connecting to the main transmission line extending from Powerhouse No. 1 via a 2.5-mile-long wood pole line.³⁰

³⁰ "System of the Mount Whitney Power and Electric Company," *Journal of Electricity, Power, and Gas*, Vol. XXXI, No. 26, December 27, 1913.

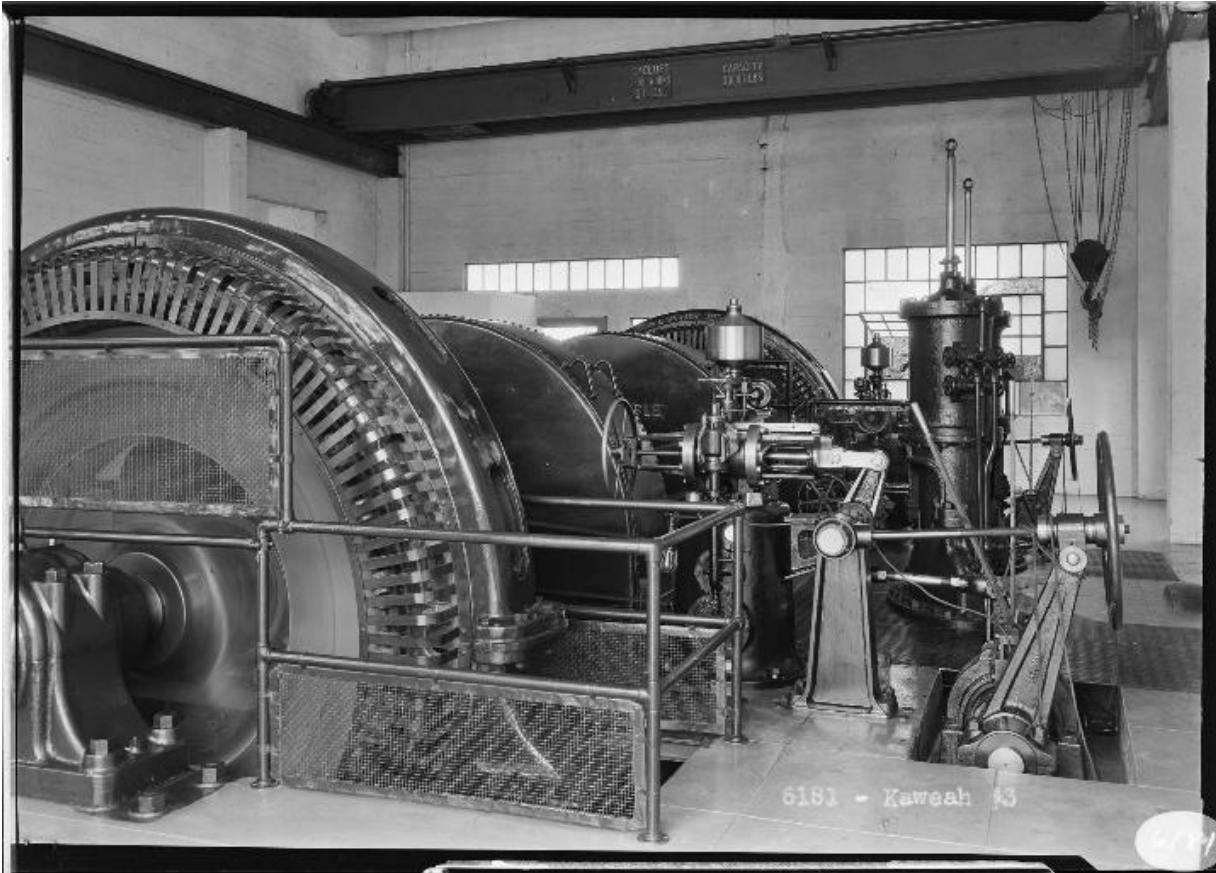

Courtesy of the Huntington Digital Library, Southern California Edison Company Photograph Collection, Call Number 02 – 06181

Figure CUL 5-17 Kaweah No. 3 Powerhouse Interior Generating Room, 1920

The Powerhouse No. 3 Penstock descended 3,000 feet from the termination of the Kaweah No. 3 Flowline, with a static head of 776 feet. The penstock was constructed with riveted steel with a 42-inch diameter that tapered to 36 inches. The pipe was trenched for the majority of the alignment, with reinforced concrete anchor blocks at vertical angles to secure the pipe to the bedrock below. A tramway was developed along the alignment to support construction of the pipeline and the forebay above, which has since removed from the site.

The Middle and Marble Fork diversion dams were relatively diminutive in size and scale, mirroring earlier system construction. The Middle Fork was of concrete construction with an Ogee spillway section. The intake was on the south bank, forming a canal wall leading to sluice gates that manually operated to control flow into the canal (Figure CUL 5-18). The Marble Fork Diversion Dam was of a similar design, with a concrete box canal diverting water to sluice gates and thence to the Marble Fork Flowline and Siphon (Figure CUL 5-19).



Courtesy of the Huntington Digital Library, Southern California Edison Company Photograph Collection, Call Number 04 - 00212

Figure CUL 5-18 Middle Fork Diversion Dam, circa 1912



Courtesy of the Huntington Digital Library, Southern California Edison Company Photograph Collection, Call Number 04 - 00259

Figure CUL 5-19 Marble Fork Diversion Dam, circa 1913

The Y-shaped integrated flowline connecting the Middle and Marble Fork diversions with Powerhouse No. 3 garnered engineering praise upon construction, with period engineering commentators noting the efficiency of the line’s inverted siphon and the advanced design of the 4-mile concrete canal:

This conduit line has a number of points of interest to engineers as it is quite unique in its design and method of construction and represents the latest engineering effort along this line. From the Marble Fork Diversion the canal is carried along the north bank of the Marble to above the junction of the two branches of the river...this terminus acts as a head box for a steel inverted siphon, which carries the flow of this canal across the Middle Fork, rising to a junction with the canal from the Middle Fork Diversion. The waters of the two branches are thus mingled and then carried in a combined canal which follows the east slope of the Middle Fork to its terminus at a forebay reservoir for Powerhouse No. 3. The ground surface followed by this conduit line is very rough and uneven, requiring a major construction effort.³¹

Depending on the terrain, the flowline sections were constructed using concrete-lined ditch or put-in-place concrete slabs, with either single slabs or double slabs set on low concrete rubble piers (Figures CUL 5-20 and 5-21). All concrete was made on site, with a crushing plant located at the confluence of the two forks of the river and a small rail track ascending to the flowline grade for transport. The inverted siphon, which carried water from the Marble Fork across the Middle Fork Kaweah River Canyon, was buried, even as it crossed the Middle Fork Kaweah River stream bed (Figure CUL 5-22). The buried siphon at the stream bed was anchored in solid concrete and buried so as to avoid damage from any flooding events. Interestingly, a second section of siphon pipe was laid next to the first under the Middle Fork Kaweah River stream bed, as at the time of construction Mount Whitney Power Company contemplated adding a second inverted siphon to the system, which ultimately never came to fruition. Because of the arduous construction techniques and the time consuming placement of the jointed concrete slab forms, construction of the siphon was estimated at approximately \$40,000 per mile.³²



Courtesy of the Huntington Digital Library, Southern California Edison Company Photograph Collection, Call Number 04 – 00276

Figure CUL 5-20 Marble Fork Flowline, circa 1912

³¹ “System of the Mount Whitney Power and Electric Company,” *Journal of Electricity, Power, and Gas*, Vol. XXXI, No. 26, December 27, 1913.

³² “System of the Mount Whitney Power and Electric Company,” *Journal of Electricity, Power, and Gas*, Vol. XXXI, No. 26, December 27, 1913.



Courtesy of the Huntington Digital Library, Southern California Edison Company Photograph Collection, Call Number 04 - 00137

Figure CUL 5-21 Marble Fork Siphon, circa 1912

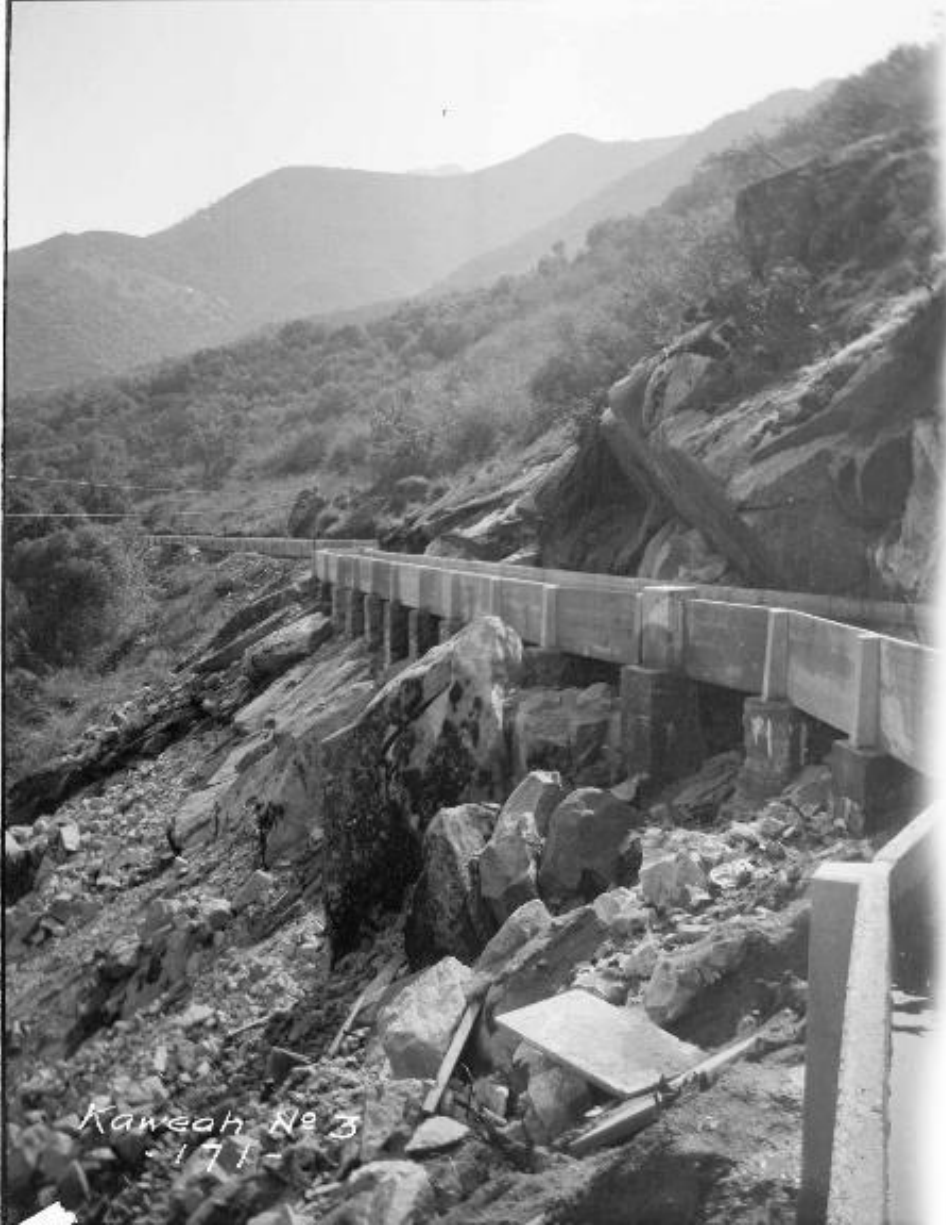

Courtesy of the Huntington Digital Library, Southern California Edison Company Photograph Collection, Call Number 04-00171

Figure CUL 5-22 Middle Fork Flowline, circa 1912

When the Kaweah No. 3 Powerhouse came on-line in May of 1913, the Kaweah No. 3 Flowline flowed directly to a steel pressure pipe leading to the powerhouse penstock, with the planned regulating forebay not yet complete. Under this interim design, the flowline terminated at a steel pipe that ran horizontally 839 feet across the hillside, leading to a stand pipe that regulated the steep descent of the vertical penstock. Upon completion of the Kaweah No. 3 Forebay, the largest of the Kaweah System with an 11 acre-foot capacity, a large section of the horizontal pipeline was abandoned, and flows were regulated by the forebay reservoir before running into a shortened section of horizontal pipe (Figure CUL 5-23). At present, an abandoned section of steel pipe is still evident on the hillside below the Kaweah No. 3 Forebay.³³

³³ "System of the Mount Whitney Power and Electric Company," *Journal of Electricity, Power, and Gas*, Vol. XXXI, No. 26, December 27, 1913.



Courtesy of the Huntington Digital Library, Southern California Edison Company Photograph Collection, Call Number 02 - 27826

Figure CUL 5-23 Kaweah No. 3 Forebay, 1947

With completion of the Kaweah No. 3 Powerhouse, the Mount Whitney Power Company cemented its regional role as the preeminent utility in Tulare County, with an invested capital of over 5 million dollars, a connected load of over 14,000 kW, and 179 miles of transmission lines that coursed through the region's towns and agricultural fields. In addition to the three hydroelectric plants the company held at Kaweah, the Mount Whitney Power Company had purchased the Globe Light and Power Company's Tule River Hydroelectric Plant in 1909 to bolster supplies, with additional steam-powered plants in Visalia and Tulare adding to the company's portfolio. Mount Whitney Power Company's central role in the physical and economic development of the region was a vaunted point of fact for California's agricultural press, with Pacific Rural Press noting in 1914 "No other factor has had a greater influence on [agricultural] development in Tulare County in recent years than the pumping plant, our larger sections today are almost wholly indebted to this new form of water supply for their recent progress." Thus, less than twenty years after initial surveys and planning, the hydroelectric supplies developed by Mount Whitney Power Company had become an inextricable component of the region's physical and economic landscape, with electricity generated by the company creating a patchwork of new development across the San Joaquin Valley, development which in and of itself spurred the need for more electrical supplies. As observed by a period commentator, electrical engineer Putnam Bates, "It is hard to tell whether the power companies made the irrigated farms or farms guaranteed the success of the power companies, the interests seem to have worked together."³⁴

³⁴ James C. Williams, *Energy and the Making of Modern California*, 225; Water Development in Tulare County," *Pacific Rural Press*, March 21, 1914, 365.

5.3.5 Industry Consolidation and Absorption by SCE

Despite Mount Whitney Power Company's strong regional market position, the company was subject to a number of serious development pressures by the mid-1910s, both specific to the company itself and related to trends of industry-wide consolidation that characterized the period. First, while the company dominated the Tulare County market, further physical growth was largely hampered by the rival developments of former partner Albert G. Wishon, whose San Joaquin Light and Power Company had developed extensively in the regions surrounding Mount Whitney Power Company's territory, and who at times seemed personally motivated to curtail Mount Whitney's success. In essence, as San Joaquin Light and Power developed facilities in the towns and watersheds surrounding Mount Whitney Power Company's facilities, the Mount Whitney Power Company became increasingly landlocked in their growth potential—with both supplies and market expansion increasingly constrained. As such, by 1916, the Mount Whitney Power Company was facing something of a crisis of supply, with even their auxiliary steam plants barely providing sufficient backup, little room for new development, and a hostile rival edging closer. In addition to this imminent crisis, by this period the larger energy context in California was in a state of upheaval. Although the period was a time of great expansion for the electrical industry as a whole, the period was also one of escalating industry consolidation, driven by both geographic considerations and increased financial pressures. While the industry was largely born of small, geographically-focused entities like Mount Whitney Power Company, by the 1910s improvements in transmission technology and capital consolidation had winnowed the field substantially—ushering in the development of a small cadre of large utilities that differed markedly from the isolated companies that had characterized the first wave of hydroelectric development. Against this backdrop, the first wave of small utilities was steadily absorbed by a small number of larger companies.³⁵

In response to these pressures, an aging John Hays Hammond, brother of William Henry Hammond and majority stockholder in the Mount Whitney Power Company, relinquished control of the Mount Whitney Power Company in 1916, selling all of his shares to Los Angeles industrial magnate Henry E. Huntington. For Huntington, the purchase served as a key chess-piece for his own hydroelectric developments, operated as Pacific Light and Power Company (PLPC). In 1913, Huntington's PLPC had completed initial developments on the San Joaquin River at Big Creek, one of California's largest and most innovative hydroelectric projects of the period. The 150 Kilovolt (kV) transmission lines of the Big Creek Hydroelectric System ran directly through the Mount Whitney Power Company's service territory as they extended to their primary market of Los Angeles. Thus, Huntington simultaneously purchased new regional supplies, and perhaps more importantly, purchased a booming Tulare County consumer market to offload the Big Creek Hydroelectric System's abundant electrical supplies.³⁶

In a testament to the rapidity of the consolidation of the period, by 1917 the former holdings of the Mount Whitney Power Company had changed hands yet again, with PLPC in turn purchased in whole by one of the state's growing electrical behemoths—SCE. The sale was completed in 1917, with the holdings of PLPC continuing to independently operate as subsidiaries of SCE until 1920. In that year, the holdings were officially absorbed, with the masthead of SCE garnering the former facilities of Mount Whitney Power Company. SCE has continued to operate the Kaweah River system in the nearly one hundred years since acquisition, with the 8.85 MW Kaweah River Hydroelectric plants serving as a small component of the utility's current 1,176 MW hydroelectric network.³⁷

³⁵ William A. Meyers, *Iron Men and Copper Wires, A Centennial History of the Southern California Edison Company* (Glendale, CA: Trans-Anglo Books, 1947, 86-91; James C. Williams, *Energy and the Making of Modern California*, 225.

³⁶ William A. Meyers, *Iron Men and Copper Wires, A Centennial History of the Southern California Edison Company* (Glendale, CA: Trans-Anglo Books, 1947, 86-91

³⁷ William A. Meyers, *Iron Men and Copper Wires, A Centennial History of the Southern California Edison Company* (Glendale, CA: Trans-Anglo Books, 1947, 86-91; "Historic-Era Electrical Infrastructure Management Program," drafted by Southern California Edison Company, August 2015.

5.3.6 Kaweah Project Operations under SCE Ownership

The most significant change to the Kaweah Project was the 1929 demolition and removal of the Mount Whitney Power Company's original 1899 Kaweah No. 1 Powerhouse. The corrugated metal powerhouse was considered functionally obsolete and replaced with a modest reinforced concrete structure located several hundred feet upstream, with a spare classical tone that mirrors both that of Kaweah Powerhouse No. 3 and general powerhouse design of the period (Figure CUL 5-24). The powerhouse was equipped with a single, single-jet, single-overhung Allis-Chalmers impulse turbine, with a rated capacity of 2.2 MW, which remains in operation today. In order to incorporate the new powerhouse, the original Kaweah No. 1 Powerhouse penstock was lengthened and realigned, with an extension linking in SCE's new facility. The powerhouse was equipped with an outdoor switchyard, reflecting general advances in switchyard design. Concurrent with the construction of the new Kaweah No. 1. Powerhouse, SCE replaced the last original generating unit in the Kaweah No. 2 Powerhouse with an Allis-Chalmers Unit, with this 1929 replacement in turn removed in 1947.³⁸



Courtesy of the Huntington Digital Library, Southern California Edison Company Photograph Collection, Call Number 02 - 23088

Figure CUL 5-24 SCE's Kaweah Powerhouse No. 1, 1940

While the Kaweah Project has continued to operate largely as designed under SCE ownership, many system components have undergone substantial material changes over the past century. These changes primarily correspond to technological innovations in hydroelectric engineering and operations as well as ongoing material alterations to address functional life spans of system components—a necessary and vital component of hydroelectric operations.

Other 1920s changes included upgrades to all system powerhouses that allowed for semi-automatic operation, thus allowing for generation without full-time station operators at each powerhouse. By the 1930s, the powerhouses were fully automatic, with all functions centrally managed. Additionally, SCE removed the original wood pole transmission lines, with the entire system upgraded to 66 kV lines and much of it carried by new steel cross-arm structures. The voltage was modest for the period and reflected the system's diminutive capacity in comparison to SCE's more substantial projects, most notably the Big Creek Hydroelectric System, which ran at 225 kV during the period.³⁹

The next major change to the system came in 1947, when the entirety of the 6-mile Kaweah No. 1 Flume was dismantled and reconstructed (Figures CUL 5-25 and 5-26). The reconstruction came after years of ongoing maintenance to the original 1899 structure, with sections repaired on a yearly basis in nearly all years between 1925 and 1940. While the original flume was of a redwood design, with redwood planks joined by batten, the new flume was built of sheet metal coated in water durable asphalt, with a redwood substructure.

³⁸ SCE Archives, Kaweah No. 1 Library, Three Rivers, SCE Drawing, "Kaweah No. 1 Station".

³⁹ SCE Archives, Kaweah No. 1 Library, Three Rivers, SCE Drawing, "Kaweah No. 2 Station" (GWO 10438); SCE Archives, Kaweah No. 1 Library, Three Rivers, SCE Drawing, "Kaweah No. 3 Station" (GWO 10439); SCE Archives, Kaweah No. 1 Library, Three Rivers, SCE



Courtesy of the Huntington Digital Library, Southern California Edison Company Photograph Collection, Call Number 02 - 27839

Figure CUL 5-25 SCE Crews Rebuilding Kaweah No. 1 Flume, 1947



Courtesy of the Huntington Digital Library, Southern California Edison Company Photograph Collection, Call Number 02 - 27830

Figure CUL 5-26 Rebuilt Kaweah No. 1 Flume, 1948

The 1947 sheet metal structure remains in place; however, changes through the present have been extensive—many stemming from environmental damage, or as termed by one observer, “mother nature” (Figure CUL 5-27). In 1986, handrails were added to the alignment, which have been serviced and replaced over time. In 1987, a forest fire burned 800 feet of the alignment. Between 1989 and 1991 much of the wood framing was rebuilt along the entirety of the alignment, with new stringers, legs, bracing, and pony bents. In 1991, a 30-foot section was washed out in a flood. Most recently, in 2018, sections of the alignment were damaged from a landslide, necessitating the rebuild of some sections, which has yet to occur (Figure CUL 5-28). As such, the alignment is an amalgamation of materials dating from 1947-2018, following an alignment that was established in 1899. The wood portions of the Kaweah No. 2 Flume have also been replaced in this manner, with only the concrete sections reflective of the original materials.⁴⁰

Drawing, “Kaweah No. 3 Station” (GWO 026023); Polly Allen and Linda Pollack, National Register of Historic Places Nomination: Big Creek Hydroelectric System Historic District, written on behalf of SCE, 2016.

⁴⁰ SCE Archives, Kaweah No. 1 Library, Three Rivers, Kaweah No. 1 Flume Files.

DAMAGE TO COMPANY'S PROPERTY	If more than one person's property was damaged, list name and address and description of damage on separate sheets.	
	What was damaged? KAWEAH NO. 1 FLUME	
	Nature and extent of damage ROCK SLIDE CRUSHED 30' OF FLUME	
	Estimated cost to: (1) Repair property (2) Replace property 3000.00	Are other repairs or replacements to be made as part of this job? <input type="checkbox"/> Yes <input checked="" type="checkbox"/> No
	Name of person causing damage MOTHER NATURE	Telephone Number
	Address	City
	Cause of damage	
	Check one of the following: <input type="checkbox"/> The facilities damaged are not within the project area. <input type="checkbox"/> The facilities damaged are within the project area.	

Southern California Edison Company Kaweah No. 1 Library, Three Rivers

Figure CUL 5-27 Kaweah No.1 Flume Damage from “Mother Nature”

In the latter decades of the twentieth century, maintenance has been continuous and ongoing throughout the system, with virtually all facilities continuously altered and upgraded to ensure operability. These physical changes are discussed in greater detail in Section 5.4 and in the DPR 523 forms in Appendix B, and generally relate to all facets of the system’s operation—from reconstruction of system diversions, flowlines, forebay apparatus, and generation and transmission equipment, to re-sheathing of the only



Photograph Taken by Cardno

Figure CUL 5-28 Broken Section of Kaweah No. 1 Flume, 2018

remaining metal-clad powerhouse, Kaweah No. 2 Powerhouse. Such changes have served to keep the Kaweah Project operating efficiently and in accordance with current technological standards—and illustrate a system that is representative of both its nineteenth and early twentieth century development history and twenty-first century functions.

5.3.7 Context Summary

While material alterations under SCE ownership have done much to shape the physical components of the Kaweah Project over the last century, perhaps equally notable is the transition of the system from a nearly wholly dedicated regional agricultural utility to its current role as a minor component of the sprawling SCE energy grid, which is characterized by interconnected transmission corridors that link vast areas of California. In large, this transition is reflective of the evolution of the utility industry as a whole, as the consumption of energy supplies has evolved from a regional context to a large and interconnected statewide pool. At present, the 8.85 MW Kaweah Project is a small component of an SCE system that includes a 50,000 square-mile service territory, upwards of 15 million customers, and over 1,100 MW of power reserves. Within this modern utility context, however, the agricultural antecedents of the Kaweah Project

remain a significant representation of California’s historical development, with the nineteenth century vision of the Mount Whitney Power Company founders defining the transformative potential of irrigated agriculture. This vision remains a central component of California’s physical identity to the present, with the San Joaquin Valley’s sprawling fields, orchards, and dairies illustrative of the state’s complex technological relationship

with water. The importance of this significant development theme is well summarized by the 1989 evaluation of the Kaweah System, which concludes:

The transformation of a sparsely populated, dry farming region to an area of prosperous plots planted with fruit trees and olive groves was looked on as nothing short of miraculous by Tulare County residents. The credit, with ample justification, went to the electrical energy made available through the Mount Whitney Power Company...The Kaweah System, constructed by Mount Whitney, was undoubtedly the single most important factor in the establishment of the type of agriculture practiced in Tulare County today. Although relatively small and similar in design to other systems developed at the same time, this gives it a significant place among the pioneer efforts.⁴¹

5.4 Updated National Register of Historic Places Inventory

As discussed in Section 4.2, all built environment resources (buildings, structures, objects) that were determined to be over 45 years of age were included as part of the Survey Population (refer to Table CUL 5-1) and subject to intensive field inventory and evaluation, all of which are documented in detail on the DPR 523 forms included in Appendix B and summarized herein. All documented resources are generally related to hydroelectric development, with all developed by Mount Whitney Power Company, or SCE in the years following system acquisition. In general, this property type is industrial and utilitarian in nature and includes resources related to water storage, conveyance, and electrical generation, as well as general operational support. All resources are summarized below, organized by system development (i.e., Kaweah No. 1, Kaweah No. 2, and Kaweah No. 3 developments). All photographs were taken by Cardno in April and May of 2018 unless otherwise noted.

5.4.1 Kaweah No. 1 Development

This section describes the built environment resources associated with the Kaweah No. 1 Development as they currently exist.

Kaweah No. 1 Powerhouse, Penstock, and Switchyard

The Kaweah No. 1 Powerhouse is a small, single story building located on the south bank of the Kaweah River. The rectangular-plan powerhouse was constructed in 1929 and is constructed of reinforced, board formed concrete and measures approximately 28 feet long by 24 feet wide (Figure CUL 5-29). Fenestration consists of bands of metal sash, multi-light industrial windows with central hopper windows situated near the base of the parapet on all sides. The building's primary entrance consists of a set of modern metal double doors with a metal security gate.

The Kaweah No. 1 Penstock extends 3,340 feet from the Kaweah No. 1 Forebay Tank, passing under State Route 198, entering the powerhouse on its south side (Figure CUL 5-30). The steel pipe varies in diameter from 19 to 48 inches, and is buried for the extent of the alignment. Portions of the pipe date to 1899, with other portions from 1929, 1967, 1984, and 1987. After the penstock enters the powerhouse, water passes through a single Allis-Chalmers impulse turbine.

The Kaweah No. 1 Powerhouse Switchyard is a modern switchyard located on a ridge just above the powerhouse. The outdoor facility contains support equipment for electrical transfer, including an overhead bus structure, three oil circuit breakers and associated single phase lightning arresters, and a single three-phase transformer. All equipment is stationed on concrete foundations and the yard is enclosed by a 6-foot galvanized cyclone fence (Figure CUL 5-31). Equipment in the switchyard has been regularly replaced and upgraded to the present. Power from the switchyard is transmitted from the Project via the 66 kV Kaweah No. 1 Tap Line and the No. 3 Powerhouse to Three Rivers Substation

⁴¹ BioSystems Analysis, Inc., A History and Significance Evaluation of the Kaweah Hydroelectric System, Tulare County, California. Submitted to the Environmental Affairs Division of SCE, 1989.

Transmission Line. The Three Rivers Substation and Transmission Line are considered Non-Project facilities, and are therefore not included in the FERC license for the Kaweah Project.



Figure CUL 5-29 Kaweah No. 1 Powerhouse, camera facing west



Figure CUL 5-30 Kaweah No. 1 Penstock alignment, camera facing south



Figure CUL 5-31 Kaweah No. 1 Switchyard, camera facing northeast

Kaweah No. 1 Diversion Dam

The Kaweah No. 1 Diversion Dam is located in the steep, rocky canyon of the East Fork Kaweah River, approximately 5 miles east of the Kaweah No. 1 Powerhouse at an elevation of 2,583 feet. The dam is a simple 6-foot tall overflow concrete gravity dam with a crest length of 20 feet (Figure CUL 5-32). The dam impounds water for diversion through a 6-foot tall by 3-foot wide unlined granite tunnel, with flow controlled by a manually operated iron slide gate. The tunnel extends approximately 50 feet west and empties into a sandbox, or sediment trap. The sandbox has board formed concrete walls, with a rock wall section and an ungated overflow spillway crest. A small concrete diversion structure projects from the hillside near the center of the sandbox. Two manually controlled sluice gates near the structure's east and west ends allow control of the water level within the sandbox. Water passes through a metal radial slide gate into the Kaweah No. 1 Flowline. The sandbox is accessed using a board platform with tubular metal hand railings, with a short flight of stairs leading to the intake control. The dam was originally constructed in 1899, with the sandbox rebuilt circa 1940 and utility features including railings, access boards, and electrical conduit replaced on an ongoing basis.

Kaweah No. 1 Flowline

The Kaweah No. 1 Flowline spans approximately 5.8 miles above the East Fork of the Kaweah River, carrying water from the Kaweah No. 1 Diversion Dam to the Kaweah No. 1 Forebay Tank for electrical generation at the Kaweah No. 1 Powerhouse. In 1947, the original redwood box flume was replaced by this half-round metal flume and the support structure completely reconstructed. As currently constructed, the metal flume is braced by a simple redwood post and beam support structure. The flume is fixed on either side to horizontal beams, supported by dual knee braces. Vertical, cross-braced posts anchored by concrete footings, ranging in height as required by the diverse terrain, elevate the flume structure to allow the flowline to maintain its gradually sloping trajectory (Figure CUL 5-33). Various sections have been replaced to the present as maintenance needs and environmental damage dictates.



Figure CUL 5-32 Kaweah No. 1 Diversion Dam and Sandbox, camera facing east



Figure CUL 5-33 Section of Kaweah No. 1 Flowline, camera facing southeast

Kaweah No. 1 Forebay Tank

The Kaweah No. 1 Forebay Tank serves as the terminus of the Kaweah No. 1 Flowline and the holding facility for electrical generation at Kaweah No. 1 Powerhouse. Located on a hillside ridge approximately 0.6 mile east of the powerhouse, the Kaweah No. 1 Forebay Tank consists of a 24-foot diameter steel tank standing 15 feet above ground level with a capacity of 0.18-acre foot (Figure CUL 5-34). Water enters the forebay tank through an ungated connection with the Kaweah No. 1 Flowline on its east side and exits the tank by passing through a large metal trash rack before entering the Kaweah No. 1 Penstock. An approximately 100-foot long overflow spillway chute extends from the tank's south side and a manually operated gate controls flow to the penstock. The spillway consists of a trestled half round metal flume with wood bracing. Water from the spillway chute falls into a natural drainage channel and flows downslope into the Kaweah River just south of the powerhouse. The existing Kaweah No. 1 Forebay Tank was constructed in 1947, replacing the original tank.

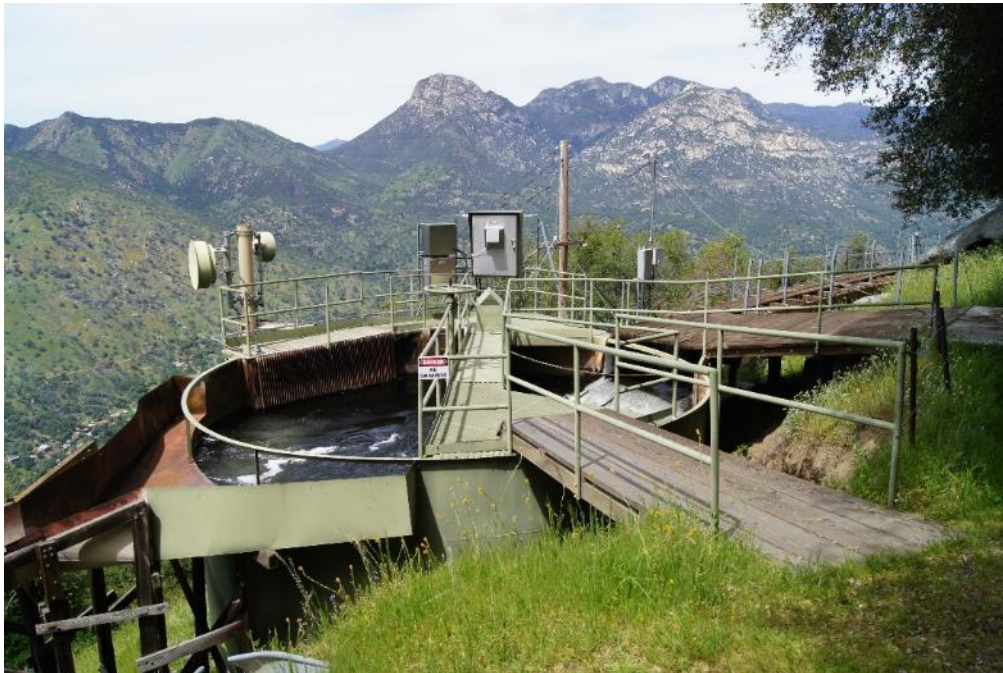

Figure CUL 5-34 Kaweah No. 1 Forebay Tank, camera facing northeast

Kaweah No. 1 Powerhouse Campus

The Kaweah No. 1 Powerhouse Campus is an assemblage of utilitarian buildings that serve as the administrative and maintenance center for the Kaweah Hydroelectric Project (Figure CUL 5-35). The campus is located on the north side of State Route 198 adjacent to Kaweah Powerhouse No. 1 and includes several historic-period buildings, including the Kaweah Office, Operator's Office, Workshop, Communication House, as well as a large, modern prefabricated Maintenance Building situated at the east end of the campus constructed circa 2011. The Kaweah Office is a single story concrete block building that was originally constructed circa 1950 and expanded in 1990. The Operators Office and Workshop are vernacular wood-frame side-gable buildings that were both built in 1927. The Communication House is a small corrugated building with a rectangular plan that was built circa 1950. Several support buildings that were developed in the 1920s were demolished and removed from the site upon construction of the 2011 garage. An above-ground domestic water supply tank that is associated with the complex is located upslope from the complex across State Route 198.



Figure CUL 5-35 Kaweah No. 1 Powerhouse Campus, camera facing northeast

Mineral King Dams

The Kaweah No. 1 Project is supported by four small high elevation reservoirs, collectively known as Mineral King Lakes, which regulate flows into small tributaries of the East Fork of the Kaweah River. These four reservoirs are located outside of the FERC Project boundary and are operated under a SUP with the SNP. Built environment features associated with the reservoirs include four small concrete masonry dams: Eagle Lake Dam, Lady Franklin Dam, Upper Monarch Lake Dam, and Crystal Lake Dam.

Eagle Lake Dam is 286 feet in length, 15 feet in height, and 5 feet in width, and is composed of stone set in cement mortar, with a concrete face (Figure CUL 5-36). The dam holds 209 acre feet at maximum capacity. The dam was originally constructed in 1904, with mortar repaired and cement added to the face on an ongoing basis to the present.

Lady Franklin Dam is 393 feet in length, 20 feet in height, and 4 feet in width, and is composed of stone set in cement mortar, with a concrete face and rockfill on the downstream side (Figure CUL 5-37). The dam holds 467 acre feet at maximum capacity and is controlled by a single manually operated gate valve. The dam was originally constructed in 1905, with mortar repaired and cement added to the face on an ongoing basis to the present.

Upper Monarch Lake Dam is 263 feet in length and 22.5 feet high and of buttressed stone masonry construction (Figure CUL 5-38). Loose rockfill is placed between the buttresses on the downstream face and a mortar cap covering the upstream face. Flow is controlled by a manually operated gate valve and the dam has an uncontrolled spillway, located on the right side of the structure. The dam impounds a maximum capacity of 314 acre feet. The dam was originally constructed in 1905, with mortar repaired, cement added to the face, and rockfill added on an ongoing basis to the present.

Crystal Lake Dam is 93 feet in length and 18 feet in height, with a width of 2 feet. The dam is composed of stone set in cement mortar, with a concrete face (Figure CUL 5-39). The dam holds 162 acre feet at maximum capacity and is controlled by a single manually operated gate valve. The dam was originally constructed in 1903, with mortar repaired and cement added to the face on an ongoing basis to the present.



Photograph SCE, 2018

Figure CUL 5-36 Eagle Lake Dam



Photograph SCE, 2018

Figure CUL 5-37 Lady Franklin Dam



Photograph SCE, 2018

Figure CUL 5-38 Upper Monarch Lake



Photograph SCE, 2018

Figure CUL 5-39 Crystal Lake Dam

5.4.2 Kaweah No. 2 Development

This section describes the built environment resources associated with the Kaweah No. 2 Development as they currently exist.

Kaweah No. 2 Powerhouse, Penstock and Switchyard

The Kaweah No. 2 Powerhouse is a utilitarian metal-clad building located just above the north bank of the Kaweah River, approximately 1 mile downstream of the Kaweah No. 1 Powerhouse. The rectangular, wood-frame building was originally constructed in 1905 and measures approximately 34 feet in width and 62 feet in length and is approximately 50 feet tall at its peak. The exterior is clad entirely with modern (circa 2000s) corrugated metal (Figure CUL 5-40). The building's primary entrance is located on the west side, with original large wood double doors replaced by a much smaller single metal door flanked by modern six-over-six double-hung metal sash windows, with matching windows directly above. Fenestration on the north wall consists of six identical six-over-six double-hung metal sash windows on the first floor level, with five similar windows on the east end in addition to a rear entrance consisting of a single metal door.



Figure CUL 5-40 Kaweah No. 2 Powerhouse, camera facing west

The Kaweah No. 2 Penstock extends 1,012 feet down the slope above the powerhouse from the Kaweah No. 2 Forebay and enters on the building's north side at an above-ground grade (Figure CUL 5-41). The buried steel pipe varies in diameter from 60 to 30 inches and was placed in 1905. After the penstock enters the powerhouse, water passes through a single Francis-type turbine. Water exits the powerhouse through a steel pipe just below the penstock entry and is diverted back to the Kaweah River through a 0.3-mile-long tailrace canal.

The Kaweah No. 2 Switchyard is located adjacent to the powerhouse on the west side of Kaweah River Drive (Figure CUL 5-42). The electricity generated in the powerhouse is transferred to the switchyard through underground conduit. The outdoor facility contains support equipment for electrical transmission, including an overhead bus structure, three oil circuit breakers and associated single phase lightning arrester, grounding switches, disconnecting switches, and a single three-phase transformer bank. All equipment is stationed on a concrete foundation and the yard is enclosed by an 8-foot chain-link fence.

Equipment in the switchyard has been regularly replaced and upgraded to the present. Power from the switchyard is transmitted from the Project via the 66 kV Kaweah No. 2 Tap Line and the Kaweah No. 3 Powerhouse to Three Rivers Substation Transmission Line.



Figure CUL 5-41 Kaweah No. 2 Penstock, camera facing north



Figure CUL 5-42 Kaweah No. 2 Switchyard, camera facing south

Kaweah No. 2 Diversion Dam

The Kaweah No. 2 Diversion Dam is located on the Kaweah River, approximately 1 mile above its junction with the East Fork and directly below Kaweah Powerhouse No. 3. The dam is situated at an elevation of 1,365 feet and is a simple, 7-foot tall masonry overflow gravity dam with a crest length of 161 feet (Figure CUL 5-43). The dam was designed to impound between 1 and 2 acre feet of water; however, over time, the diversion pool has filled in with sediment and currently has an approximately 0.2 acre-foot capacity. Impounded water is diverted through a metal trash rack near the upstream dam face and into the large, modern concrete intake structure. Head-gate valves control flow into a 54-inch diameter by 42-foot long underground steel pipe. An automated steel slide gate controls flow into the Kaweah No. 2 Flowline, and is accessed using a concrete flood control wall with a tubular metal guard rail. A modern concrete block control building is located just upslope from the outlet into the Kaweah No. 2 Flowline. The small, rectangular, single story building has a shed roof with wood fascia board and a single metal entrance door on its east side. Steel conduit runs from the building's south side, down the slight slope to the automated facility devices. While the dam was initially constructed in 1905, the intake was entirely reconstructed in 1938 and subsequently in 2012-2013.



Figure CUL 5-43 Kaweah No. 2 Diversion Dam, camera facing west

Kaweah No. 2 Flowline

The Kaweah No. 2 Flowline extends approximately 21,607 feet along the gently sloping hillside above the north side of the Kaweah River, carrying water from the Kaweah No. 2 Diversion to the Kaweah No. 2 Forebay. The approximately 4-mile-long flowline consists of 16,738 feet of simple concrete-lined ditch, 3,822 feet of steel flume, and a 1,047-foot-long steel siphon pipe. The concrete-lined ditch segments are generally slightly wider than the flume spans and rest just below ground level with rounded edges, narrowing at the end as they meet the flume spans (Figure CUL 5-44). These segments are essentially modern, with concrete poured in the 1980s. The steel flume segments are utilized where the flowline

alignment crosses open ravines. Originally the flume sections were comprised of redwood, which was reconstructed using half round metal flume in 1948 (Figure CUL 5-45). The thin, half round metal sheets are braced by metal crossbars every few feet. The original wood support structures have been replaced primarily by modern, riveted steel support structures with concrete footings, with only a few flume segments supported by replacement wood structures remaining. Flume segments are accessed using wood plank catwalks placed directly on top of the steel braces. A 50-inch diameter steel siphon pipe protected by a large metal trash rack carries the flowline under State Route 198.



Figure CUL 5-44 Kaweah No. 2 Flowline, camera facing west



Figure CUL 5-45 Flume Section of Kaweah No. 2 Flowline, camera facing west

Kaweah No. 2 Forebay

The Kaweah No. 2 Forebay serves as the terminus of the Kaweah No. 2 Flowline and the regulating facility for electrical generation at Kaweah No. 2 Powerhouse. The Forebay consists of a small, concrete reservoir with a holding capacity of 0.75 acre foot that is essentially a continuation of the Kaweah No. 2 Flowline, consisting of a linear section of canal body that measures 180 feet in length, 13 feet in width, and 14 feet in depth (Figure CUL 5-46). A large, automated metal trash rack structure prevents debris from entering the penstock, with the intake for the penstock approximately 20 feet from the west end of the reservoir. The forebay is entirely lined with a layer of replacement gunite, covering the original concrete reservoir body. A small corrugated metal auto control building stands adjacent to the reservoir.



Figure CUL 5-46 Kaweah No. 2 Forebay and Trash Rack, camera facing west

5.4.3 Kaweah No. 3 Development

This section describes the built environment resources associated with the Kaweah No. 3 Development as they currently exist. Note the diversion dams and flowlines associated with this development are considered Non-Project facilities because they are located within the SNP, are operated under a SUP and not under the FERC license. However, these facilities are described herein for contextual purposes, as requested by the NPS. The Kaweah No. 3 Powerhouse, penstock, and switchyard are located outside of the SNP and are therefore Project facilities, operated under the FERC license.

Kaweah No. 3 Powerhouse, Penstock, and Switchyard

The Kaweah No. 3 Powerhouse is located near the east bank of the Kaweah River, approximately 2 miles upstream from the Kaweah No. 1 Powerhouse. The rectangular building was constructed in 1913 and is of a two-story, reinforced concrete design with restrained classical detailing (Figure CUL 5-47). The powerhouse measures approximately 51 feet in length, 51 feet in width, and has a height of 35 feet, with a flat roof framed by a simple stepped parapet. Pilasters mark each corner of the building, with two additional pilasters spaced evenly across each wall, which extend to the top of the parapet wall. Bands of metal sash, multi-light industrial windows with central hopper windows are located just below the roofline on each side. A short concrete staircase with a tubular metal hand rail leads to the building's main entrance at the center of its south side.



Figure CUL 5-47 Kaweah No. 3 Powerhouse, camera facing north

The Kaweah No. 3 Penstock extends 3,151 feet down a steep rocky hillside above the powerhouse from the Kaweah No. 3 Forebay and enters the powerhouse on the building's east side (Figure CUL 5-48). The buried steel pipe varies in diameter from 36 to 42 inches. Several support structures, including older concrete structures and modern concrete block, support the pipe near its entrance into the powerhouse. After the penstock enters the powerhouse, water passes through two single-jet, single-overhung impulse turbines. Water exits the powerhouse through a short concrete tailrace canal, returning the discharged water to the Kaweah River. A modern chain-link metal fence encloses the tailrace canal.

The Kaweah No. 3 Switchyard is located adjacent to the powerhouse, near the building's west side (refer to Figure CUL 5-47). The outdoor facility contains support equipment for electrical transfer, including an overhead bus structure, one remotely operated oil circuit breaker and associated single phase lightning arrester, grounding switches, disconnecting switches, and a transformer bank consisting of four single phase transformers. One of the four transformers is inactive and serves as a spare. Equipment in the switchyard has been regularly replaced and upgraded to the

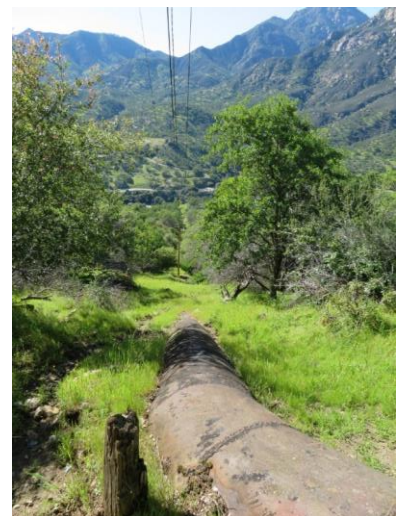

Figure CUL 5-48 Kaweah No. 3 Penstock, camera facing west

present. Power from the switchyard is transmitted from the Project via the 66 kV Kaweah No. 3 Powerhouse to Three Rivers Substation Transmission Line.

A single story garage building with a rectangular footprint, Building 0121, is located just southwest of the powerhouse (Figure CUL 5-49). The wood-frame building was constructed in 1948 and is topped with a moderately pitched side gable, corrugated metal roof with slight eave overhang and exposed rafter tails. The building is clad with corrugated metal and has a series of sliding wood barn doors on its east side.



Figure CUL 5-49 Kaweah No. 3 Powerhouse Garage, camera facing northwest

The powerhouse is accessed by a vehicular bridge crossing the Kaweah River (Figure CUL 5-50). The small bridge consists of steel girders carried by four concrete abutments, overlain by wood decking. The bridge was completed in 1957, following major flooding in 1955 that washed out the original access bridge.



Figure CUL 5-50 Kaweah No. 3 Powerhouse Bridge, camera facing west

Marble Fork Diversion Dam

The Marble Fork Diversion Dam is located on the Marble Fork of the Kaweah River, within the SNP approximately 0.5 mile north of State Route 198. Situated at an elevation of 2,180 feet, the dam is a simple 6-foot tall overflow concrete gravity dam with a crest length of approximately 50 feet (Figure CUL 5-51). Impounded water flows into an approximately 250-foot-long concrete sandbox, or sediment trap, located on the east side of the Marble Fork (Figure CUL 5-52). The west wall of the sandbox serves as an ungated overflow spillway, allowing excess water to flow freely back into the river. Three sluice gates along the west side of the structure, at the structure's north and south ends and in the center, allow for the release of water through iron pipes near the base of the sandbox. A modern grated steel walkway with tubular metal hand rails provides access to the central sluice gate. Before leaving the sandbox, water passes through a large trash rack structure, with flow into the Marble Fork Flowline controlled by dual manually operated iron slide gates set in a concrete structure. The dam was constructed in 1913 and is largely structurally unaltered with alterations limited to repair of concrete, maintenance, and in-kind replacement of control and safety features.

Marble Fork Flowline and Siphon

The Marble Fork Flowline extends along a winding, wooded ridge above the Marble Fork of the Kaweah River, carrying water from the Marble Fork Diversion Dam to the Middle Fork / Kaweah No. 3 Flowline via the Marble Fork Siphon. The approximately 2,800-foot long Marble Fork Flowline is composed of sections of concrete box flume and concrete-lined ditch (Figures CUL 5-53 and 5-54). Flow into the Marble Fork Flowline is controlled by large slide gates at the south end of the Marble Fork Diversion Sandbox, and the conduit begins with an extended flume section. The flume sections are built of thick, reinforced board form concrete slabs with approximately 5-foot tall walls supported by simple concrete buttresses. As the terrain along the ridge rises and falls, the conduit transitions from concrete flume to simple concrete-lined ditch to maintain its gradually sloped design. Concrete-lined ditch sections are slightly wider with rounded edges.

The terminus of the Marble Fork Flowline is located in a ditch segment, just above the Middle Fork of the Kaweah River, and serves as the headbox for diversion into the Marble Fork Siphon (Figure CUL 5-55). Water first passes through a metal trash rack on the south side of the ditch before flowing downhill into the Marble Fork Siphon, a 48-inch riveted steel pipe extending 1,085 feet from the terminus of the Marble Fork Flowline, connecting to the Middle Fork Flowline (Figure CUL 5-56). A layer of concrete protects the siphon where it crosses the bed of the Middle Fork of the Kaweah River, just east of the Middle Fork Bridge. After crossing the river the siphon continues uphill where it empties into the Middle Fork Flowline. The siphon is generally parabolic in design, with water plunging downhill from the Marble Fork Flowline, crossing the Middle Fork Kaweah River, and rising again to meet with the waters of the Middle Fork Flowline (Figure CUL 5-57). The majority of the siphon is buried or covered in cobble, with only isolated sections evident. The Marble Fork Flowline and Siphon remains largely as constructed in 1913, with some areas of concrete repair and resurfacing evident along the conduit.



Figure CUL 5-51 Marble Fork Diversion Dam, camera facing north



Figure CUL 5-52 Marble Fork Diversion Dam Sandbox, camera facing south



Figure CUL 5-53 Marble Fork Flowline flume section, camera facing southwest



Figure CUL 5-54 Marble Fork Flowline ditch section, camera facing southwest



Figure CUL 5-55 Marble Fork Siphon Headbox, camera facing southeast



Figure CUL 5-56 Marble Fork Siphon, camera facing east



Figure CUL 5-57 Junction of Marble Fork Siphon and Middle Fork Flowline

Middle Fork Diversion Dam

The Middle Fork Diversion Dam is located on the Middle Fork Kaweah River, just south of State Route 198 in SNP. The dam is similar in design to the Marble Fork Diversion Dam and was constructed concurrently to the Marble Fork Dam in 1912-1913. The dam is situated at an elevation of approximately 2,180 feet and is a simple 6-foot tall overflow concrete gravity dam with a crest length of approximately 50 feet. Impounded water is diverted into an approximately 300-foot-long concrete sandbox (Figure CUL 5-58). The west wall of the sandbox serves as an ungated spillway, allowing excess water to flow freely back into the river. Two manually operated slide gates located along the sandbox's north side allow for the release of excess water. One slide gate is situated near the structure's west end and is accessed using a grated metal platform with tubular metal hand rails, while a second slide gate is accessed using a modern grated steel walkway with tubular metal hand rails crossing the structure near the middle of the sandbox. Before leaving the sandbox, water passes through a large concrete trash rack structure, with flow into the Middle Fork Flowline controlled by dual manually operated iron slide gates (Figure CUL 5-59). The dam is largely structurally unaltered with alterations limited to repair of concrete along the sandbox, facility maintenance, and in-kind replacement of control and maintenance safety features.



Figure CUL 5-58 Middle Fork Diversion Dam, camera facing east



Figure CUL 5-59 Middle Fork Diversion Dam Sandbox, camera facing west

Middle Fork Flowline / Kaweah No. 3 Flowline

The Middle Fork Flowline extends approximately 4.5 miles along a winding, wooded ridge on a steep hillside above the Middle Fork Kaweah River, carrying water from the Middle Fork and Marble Fork Diversion Dams to the Kaweah No. 3 Forebay. The majority of the flowline is located in the SNP. The flowline is comprised primarily of extended spans of concrete box flume, with a short concrete-lined ditch segment (Figures CUL 5-60 and 5-61). After passing through two large slide gates at the south end of the Middle Fork Diversion Sandbox, diverted water enters a concrete box flume traveling gradually downslope in a generally westerly direction. The design of the extended flume segments of the Middle Fork Flowline mirrors that of the Marble Fork Flowline, with its thick, reinforced board form concrete slab construction with approximately 5-foot tall walls supported by simple concrete buttresses (Figure CUL 5-62). The concrete flume typically rests directly on the ground, however concrete footings are used where the ground is uneven. Several of these footings have been replaced in the years since constructions. Three short sections of modern wood box flume are supported by wood trellis structures where the original concrete box flowline has been washed out.

The flowline receives additional water from the Marble Fork Flowline via the Marble Fork Siphon, which travels across the Middle Fork Kaweah River Canyon. The riveted steel pipe penetrates the concrete flume walls of the Middle Fork Flowline at a sharp bend in the channel, approximately 3,230 feet from the Middle Fork Diversion Dam. From this junction, the flowline continues in its generally westerly direction toward the Kaweah No. 3 Forebay and consists of approximately 5200 feet of simple, concrete-lined ditch and 15,700 feet of concrete box flume. The Middle Fork Flowline has remained largely unaltered since construction, with the exception of routine maintenance and necessary repairs to footings and flume walls, and the addition of a one-half inch layer of gunite lining along the flowline added between 1946 and 1947.



Figure CUL 5-60 Middle Fork Flowline concrete box flume section, camera facing southwest



Figure CUL 5-61 Middle Fork Flowline concrete ditch section, camera facing south



Figure CUL 5-62 Middle Fork Flowline, representative buttress and pier, camera facing west

Kaweah No. 3 Forebay

The Kaweah No. 3 Forebay serves as the terminus of the Middle Fork / Kaweah No. 3 Flowline and the regulating and storage facility for electrical generation at Kaweah No. 3 Powerhouse (Figure CUL 5-63). Located on a man-made plateau approximately 0.4 mile east of the powerhouse, the Kaweah No. 3 Forebay is a gunite-lined embankment forebay with a capacity of approximately 11 acre feet. Water enters the oval-shaped reservoir by passing through a metal trash rack at the north end of the forebay, at its connection to the Middle Fork Flowline, with flow into the reservoir controlled by a pair of manually controlled iron slide gates (Figure CUL 5-64). Water exits the reservoir by passing through a metal trash rack, below water level, at the south side of the reservoir and into a metal pipe connecting to the Kaweah No. 3 Penstock. Flow into the drainage pipe is controlled by a manually operated slide gate. An approximately 75-foot-long concrete-lined spillway chute extends from the forebay's north end, at its connection with the Middle Fork Conduit, and discharges water into a natural drainage. The Kaweah No. 3 Forebay was completed in 1913, with the forebay relined with gunite in 1947 and 2012 (Figure CUL 5-65).



Figure CUL 5-63 Kaweah No. 3 Forebay, camera facing east



Figure CUL 5-64 Terminus of Kaweah No. 3 / Middle Fork Flowline at Kaweah No. 3 Forebay, camera facing west



Figure CUL 5-65 Kaweah No. 3 Forebay Outlet, camera facing south

5.4.4 Built Environment Resources Associated with General Project Operations

This section describes the ancillary structures and features associated with the Kaweah Project, including stream gages and transmission facilities, and several modern features. These ancillary structures and features are primarily used to support general Project operations.

Kaweah Hydroelectric Project Stream Gages

The Project utilizes eight stream gaging stations to measure the flow of water near its facilities along the Kaweah River. These stream gages are generally located just below the system’s dams and powerhouses. The gages typically consist of cylindrical riveted corrugated metal casings with conical tops. Small doors on the side of the gaging stations allow access to internal electronic gaging equipment (Figure CUL 5-66). While gages have been employed since Project inception, only one of the current gages, Gage 201, which is located below the Kaweah No. 3 Powerhouse, dates to the historic period, 1952. The other extant gages are modern-era replacements to original gages (Table CUL 5-2).



Figure CUL 5-66 Kaweah Stream Gage 201, camera facing south

Table CUL 5-2 SCE Kaweah Stream Gages

SCE Gage #	USGS Station #	Construction Date
201	USGS 11208730	1952
201a		1995
202		2002
200a	USGS 11208800	2002
203	USGS 11208600	1993
204a		2005
205a	USGS 11208818	2002
206a	USGS 11208565	2002

Kaweah Hydroelectric Project Transmission and Distribution Lines

The Kaweah Hydroelectric Project includes transmission, distribution, and communication lines to transmit electricity from the Project and to control operations throughout the system. The primary transmission line is the 66 kV Kaweah No. 3 Powerhouse to the Three Rivers Substation line that extends approximately 4 miles, running from the Project to the Non-Project distribution substation. Two short 66 kV tap lines from Kaweah No. 1 and No. 2 switchyards connect to this main transmission corridor. All transmission lines were constructed using wood poles, which have been replaced over time. At present, the transmission alignment is characterized by modern period tubular steel poles and a small number of wood poles from different development eras ranging from the mid-twentieth century to the 2000s (Figure CUL 5-67).



Figure CUL 5-67 Kaweah Powerhouse No. 3 to Three Rivers Substation Transmission Line, camera facing south

In addition to the three transmission lines, the Project includes 13 low voltage distribution lines that support internal Project operations as well as six fiber communication lines. These distribution and communication lines are carried by utilitarian wood and metal poles from a variety of periods (circa 1960s to 2010s) (Figure CUL 5-68).

Kaweah Hydroelectric Project Modern Facilities and Features

The Kaweah Project includes a variety of modern support features including cableways, satellite repeaters, solar panels, wildlife bridges and escape ramps along flowlines, several small footbridges, and Project gravel access road grades and trails without historic period environment infrastructural components (i.e., bridges, walls, retaining walls). All of these features are less than 45 years old. Since these features are less than 45 years old, by definition, they do not contain built environment buildings, structures, or objects that possess the potential for eligibility to the NRHP. Therefore, they were not recorded or documented as part of this study effort.



Figure CUL 5-68 Kaweah No. 1 Forebay Tank Communication Line, camera facing east

5.5 Updated and New National Register of Historic Places Evaluation

This section provides an evaluation of the Kaweah Hydroelectric Project facilities in relationship to the NRHP eligibility criteria codified in the NHPA. Each historic period built environment component located in the Project APE is evaluated both as an individual property and as a contributor to the Kaweah Hydroelectric District, which was identified during the previous relicensing effort.

5.5.1 Evaluative Framework

Based upon the research, outreach, and field survey undertaken as part of this study effort, qualified personnel under the SOI PQS analyzed all historic period built environment resources in the Survey Population for NRHP eligibility using the following criteria:

- **Criterion A:** Resources that are associated with events that have made a significant contribution to the broad patterns of our history.
- **Criterion B:** Resources that are associated with the lives of significant persons in our past.
- **Criterion C:** Resources that embody the distinctive characteristics of a type, period, or method of construction, or that represent the work of a master, or that possess high artistic values, or that represent a significant and distinguishable entity whose components may lack individual distinction.
- **Criterion D:** Resources that have yielded or may be likely to yield, information important in history or prehistory.

In addition to significance under one or more of the criteria listed above, a resource must also possess integrity, defined by seven aspects as follows:

- **Location:** the place where the historic property was constructed or the place where the historic event took place.
- **Design:** the composition of elements that constitute the form, plan, space, structure, and style of a property.
- **Setting:** the physical environment of a historic property that illustrates the character of the place.

- **Materials:** the physical elements combined in a particular pattern or configuration.
- **Workmanship:** the physical evidence of the crafts of a particular culture or people during any given period of history.
- **Feeling:** the quality that a historic property has in evoking the aesthetic or historic sense of a past period of time.
- **Association:** the direct link between a property and the event or person for which the property is significant.

NRHP analysis was based upon all pertinent cultural resources guidance and best practices including *National Register Bulletin 15: How to Apply the National Register Criteria for Evaluation*.⁴²

Because the criteria of the California Register of Historical Resources (CRHR) generally aligns with that of the NRHP, resources were also evaluated under this evaluative framework, which is codified at California Code of Regulations, Title 14, Division 3, Chapter 11.5, Section 4850 et seq.

5.5.2 Previous Resource Evaluations

As discussed in Section 5.2, the majority of built environment resources in the Survey Population were previously surveyed and evaluated in association with the previous Kaweah Project relicensing effort. The survey and evaluation results are documented in a comprehensive single report: *A History and Significance Evaluation of the Kaweah Hydroelectric System, Tulare County, California*, authored by Lehman et al., on behalf of SCE in 1989.

In the 1989 documentation, the historic built environment features associated with the Kaweah No. 1 and Kaweah No. 2 portions of the Project were found ineligible for listing in the NRHP, largely because of a lack of physical integrity to convey significance. Conversely, the documentation found that select components of Kaweah No. 3 possessed significance and integrity as contributors to a historic district under Criteria A and C of the NRHP because of their associations with the development of hydroelectric capacity for agricultural pump irrigation (Criterion A) and their pioneering hydroelectric design (Criterion C). The district was referred to as the Kaweah No. 3 Hydroelectric System Historic District.

As documented in 1989, the components that were identified as eligible for the NRHP included the Kaweah No. 3 Powerhouse and Penstock (also determined individually eligible), the Marble Fork Flowline and Siphon, Middle Fork/ Kaweah No. 3 Flowline, and the Kaweah No. 3 Forebay. Remaining Kaweah No. 3 facilities, including the Middle Fork and Marble Fork Diversion Dams, were found ineligible because of a lack of integrity. The SHPO concurred with all of the district eligibility findings in a letter dated March 21, 1990 (Reply: FERC890210A).

An excerpt from the 1989 significance evaluation is provided below. For further detail regarding the evaluation refer to the complete report included in Appendix C.

The Kaweah Hydroelectric System is composed of many historic buildings and structures. Several of these resources represent the pioneering efforts of Mount Whitney Power Company to introduce electric power into the rural agricultural setting. Other elements of the system represent not early development, rather they are tied to the long period of operation, maintenance, and modification which has resulted in the present day configuration of the system.

Kaweah No. 1. *Kaweah Powerhouse No. 1 is architecturally interesting, but not distinctive among other small powerhouse of its time of construction (1928-1929). While the powerhouse is the focal point of the Kaweah System, it is not representative of the original design or construction (either*

⁴² *National Register Bulletin 15: How to Apply the National Register Criteria for Evaluation*. National Park Service, 2002 Website accessed October 10, 2015: <http://www.nps.gov/nr/publications/bulletins/nrb15/>.

architecturally or technologically), since it replaced the original Powerhouse No. 1. As such these elements of the system do not appear to satisfy either Criterion A or Criterion C of the NRHP.

Kaweah No. 2. Built in 1905, Powerhouse No. 2 is also historically and architecturally interesting. The industrial architectural style of this structure is practical, and reflects the limited financial backing which Mount Whitney Power Company possessed in its early years. The construction materials are an interesting mix, with wood framing commonly used in industrial structures before 1900 and corrugated iron sheathing and roofing commonly used after 1900. It represents a transitional period in use of construction materials...While Powerhouse No. 2 is historically interesting it does not appear to embody the characteristics which would make it eligible under NRHP Criteria A or C. If particular importance are the many significant modifications made to the generation equipment since the original date of construction (1913, 1929, 1947). The remaining associated historic structures, while little modified are not distinctive individually.

Kaweah No. 3. Kaweah Powerhouse No. 3, constructed in 1913, is historically and architecturally interesting. The industrial architectural style of this structure is attractive, and a good representation of early 20th century reinforced concrete construction. It represents increased prosperity for the Mount Whitney Power and Electric Company, when compared to the building materials used for Kaweah No. 1 and Kaweah No. 2. The integrity of the structure is excellent and in fine condition, having undergone virtually no alterations. For the most part it also contains the original powerhouse equipment...Kaweah No. 3's Marble and Middle Fork Conduits [Flowlines] possess substantial historical significance. Virtually no alterations have been made to the conduits since their construction, although regular repairs to washed out and leaking sections have been made. The dam and intake structures of both conduits underwent repairs in 1968, and at the same time retaining walls along the conduit to Kaweah No. 3 were repaired, but the conduit repairs in no way damaged nor detract from the original construction. These are especially unique engineering features, embodying a distinctive method of construction as well as being associated with events that have made significant contributions to the broad patterns of hydroelectric and irrigation history in California. They should be nominated for listing on the National Register of Historic Places under Criteria A and C.

5.5.3 Updated Resource Evaluation

This section provides an updated evaluation of the Kaweah Hydroelectric Project, and considers all of the facilities included in the Survey Population identified in Table CUL 5-1. Note that the Survey Population includes facilities that were evaluated during the previous relicensing effort, and facilities that were not evaluated because they were not 50 years old at the time of the previous relicensing effort.

Overview

Because of the length of time that has passed since the previous recordation and the fact that the previous recordation did not formally inventory and evaluate some components of the Project because at the time the facilities were not yet 50 years of age, this inventory provides an updated NRHP evaluation to account for all historic period built environment resources in the Survey Population.

This updated evaluation generally agrees with the findings of the previous evaluation effort. As documented in the 1989 report, the development of the Kaweah Hydroelectric Project from 1898 to the sale of the Project by the Mount Whitney Power Company in 1916 is reflective of a significant phase of development in both Tulare County and in California's hydroelectric development as a whole. The Kaweah developments of the Mount Whitney Power Company are significant under Criterion A for their association with the broad and significant pattern of agricultural expansion and development in Tulare County and the surrounding region. Under Criterion C, the development of the Kaweah Project is reflective of a significant type, period, and method of construction as a late nineteenth and early twentieth century hydroelectric facility.

Within this significant development context, this evaluation also concurs with the previous analysis that only built environment resources associated with the Kaweah No. 3 development retain sufficient system integrity to convey these significant development associations. Conversely, resources associated with the Kaweah No. 1 and No. 2 developments lack sufficient physical integrity to the potential period of significance to convey significant development associations through integrity of location, design, workmanship, materials, setting, feeling, and association. As such, this evaluation finds that only the Kaweah No. 3 Hydroelectric System historic period built environment resources appear eligible for listing in the NRHP as a historic district, with a period of significance spanning from construction in 1913 to sale of the company in 1916 to PLPC and a regional level of significance reflecting its Tulare County and San Joaquin Valley development associations.

While this updated analysis generally concurs with the previous evaluation efforts, the analysis augments the earlier NRHP findings in several key areas, as itemized below and described in greater detail in the following sections.

- While the previous evaluation found that the Marble and Middle Fork Diversion Dams did not contribute to the Kaweah No. 3 Hydroelectric System NRHP Historic District and as such were ineligible for listing in the NRHP, this updated analysis finds that they do appear to contribute to the established historic district because of their contextual, functional, and operational associations and as such recommends that the resources be included as contributors to the Kaweah No. 3 Hydroelectric System Historic District.
- While the previous evaluation found that the Kaweah No. 3 Powerhouse appeared individually eligible for the NRHP as well as eligible as a contributor to the Kaweah Hydroelectric System NRHP Historic District, the updated evaluation finds that the powerhouse does not appear to be individually eligible for listing. Rather the NRHP significance of the resource is embodied in its functional, operational, and contextual relationship to the Kaweah No. 3 Hydroelectric System as a whole, and as such appears eligible for the NRHP as a contributor to the district under Criteria A and C and not additionally as an individual historic property.
- The updated evaluation provides NRHP analysis for Project facilities that were not formally addressed under the previous evaluation, finding that the Project's stream gages and transmission, distribution, and communication lines appear ineligible for listing in the NRHP as either components of the Kaweah No. 3 Hydroelectric System Historic District or as individual properties.

More detailed / updated NRHP analysis is included below, organized by development. For further analysis and documentation regarding all of the evaluated resources, please refer to the DPR 523 in Appendix B.

Kaweah No. 1 Development

Consistent with the 1989 NRHP evaluation, none of the built environment resources associated with the Kaweah No. 1 development appear to be eligible for listing in the NRHP or CRHR, as individual resources or as contributors to a district (Table CUL 5-3). Although the Kaweah No. 1 development was the first development undertaken by the Mount Whitney Power Company in 1898-1899, and as such holds significant historical and contextual associations, virtually all vestiges of this nineteenth century era of development have been removed. Specifically, the powerhouse was demolished and reconstructed in a different location and form in 1929; the penstock was lengthened and largely rebuilt in 1929, 1967, 1984, and 1987; the Kaweah No. 1 Diversion Dam was largely rebuilt in 1940; the Kaweah No. 1 Flowline and the Kaweah No. 1 Forebay Tank were entirely reconstructed in 1947. As such, while the Kaweah No. 1 development has antecedents that relate to the significant development history of the Mount Whitney Power Company and California's pioneering electrical development, extant elements lack sufficient physical or operational fabric to convey these development associations through cohesive integrity of design, workmanship, materials, feeling, and association.

Table CUL 5-3 Updated NRHP Status of Built Environment Resources Associated with the Kaweah No. 1 Development

Resource Name	Construction Date	Previous NRHP Evaluation Status	Updated NRHP Evaluation Status
Kaweah No. 1 Powerhouse and Penstock	1898; 1928-1929	6Y	6Z (Found ineligible for NR, CR or local designation through survey evaluation)
Kaweah No. 1 Diversion Dam	1898; 1940	6Y	6Z
Kaweah No. 1 Flowline	1947	6Y	6Z
Kaweah No. 1 Forebay Tank	1947	6Y	6Z
Kaweah No. 1 Powerhouse Campus	1927; circa 1950; 1990	6Y	6Z
Mineral King Dams	1903-1905	6Y	6Z

Notes: CR = California Register
NR = National Register

Under Criterion A, or CRHR Criterion 1, as a holistic operating system, the Kaweah No. 1 built environment resources are not physically associated with or representative of significant historical developments of the Mount Whitney Power Company or with the establishment of nineteenth century electrical systems in support of agricultural irrigation. Instead, the resources are largely reflective of multiple periods of twentieth century development under SCE. Within this twentieth century SCE context, the resources are not significant under Criterion A, as the maintenance and reconstruction of the Kaweah No. 1. Development was a small component of the company’s extensive hydroelectric portfolio during the period and as such is not indicative of significant patterns of development or historical themes associated with company development or utility development in general.

Under Criterion B, or CRHR Criterion 2, none of the Kaweah No. 1 development built environment resources are directly associated with significant individuals related to either the corporate development of the Mount Whitney Power Company or the development of SCE. Because much of the physical fabric is not original to the nineteenth century period, the resources lack direct physical or operational association with the pioneering founders of the Mount Whitney Power Company. Additionally, there is no indication that they are associated with any notable figures in SCE’s twentieth century development.

Under NRHP Criterion C, or CRHR Criterion 3, the Kaweah No. 1 built environment facilities are not reflective of a cohesive design or engineering that merits consideration under this Criterion in relation to individual or district eligibility. As discussed, virtually the entirety of the Kaweah No. 1 system was reconstructed between 1929 and the 1960s, with little engineering fabric that relates to initial development. Sole operational features that do relate to the initial Mount Whitney Power Company development period are limited to the Mineral King Dams, constructed in 1903-1905 to modestly augment flows. As such, as an operating whole, extant elements of the system, while contextually associated with initial nineteenth century development, exist as an amalgam of materials and design, with insufficient integrity of materials, workmanship, design, feeling, and association to convey cohesive engineering or design themes under Criterion C.

Lastly, under Criterion D, or CRHR Criterion 4, information potential is limited as most materials do not date to any significant development period. As such, it is unlikely that resources would convey information regarding hydroelectric construction techniques that is not readily available in the archival record.

Kaweah No. 2 Development

Consistent with the 1989 NRHP evaluation, none of the built environment resources associated with Kaweah No. 2 development do not appear to be eligible for listing in the NRHP or CRHR, as individual resources or as contributors to a district (Table CUL 5-4). Although the Kaweah No. 2 development was constructed in 1905 by the Mount Whitney Power Company, augmenting the generation capacity of the Powerhouse No. 1 development, a lack of cohesive physical integrity precludes eligibility for the NRHP or CRHR. While the powerhouse remains in the same location, the building has been entirely re-clad in modern metal siding and the original turbines and generators have been replaced, with generating equipment reconfigured and replaced in 1913, 1929, and 1947. The Kaweah No. 2 Diversion Dam was largely rebuilt in 1938 and 2012-2013, resulting in a dam that functions and appears as a modern diversion rather than the original granite masonry dam. While the Kaweah No. 2 Flowline follows the same alignment as constructed, the facility was rebuilt with new trestle structures and half-round metal in 1948, entirely replacing the original redwood flume design. As such, while this portion of the Project has some physical components that relate to the continuing development of the Mount Whitney Power Company in the early twentieth century, these extant elements lack sufficient physical or operational fabric to convey these development associations through cohesive integrity of design, workmanship, materials, feeling, and association.

Table CUL 5-4 Updated NRHP Status of Built Environment Resources Associated with the Kaweah No. 2 Development

Resource Name	Construction Date	Previous NRHP Evaluation Status	Updated NRHP Evaluation Status
Kaweah No. 2 Powerhouse and Penstock	1905	6Y	6Z
Kaweah No. 2 Diversion Dam	1905, 1938, 2012-13	6Y	6Z
Kaweah No. 2 Flowline	1905, 1948; 1984	6Y	6Z
Kaweah No. 2 Forebay	1905; 1946	6Y	6Z

Under Criterion A, or CRHR Criterion 1, as a whole, the Kaweah No. 2 built environment resources are not physically associated with or representative of significant historical developments of the Mount Whitney Power Company or with the establishment of early twentieth century electrical systems in support of agricultural irrigation. Instead, the resources are largely reflective of multiple periods of twentieth century development under SCE.

Within this twentieth century SCE context, the resources are not significant under Criterion A, as the maintenance and reconstruction of the Kaweah System was a small component of the company's extensive hydroelectric portfolio during the period and as such is not indicative of significant patterns of development or historical themes associated with company development or utility development in general.

Under Criterion B, or CRHR Criterion 2, none of the Kaweah No. 2 built environment resources are directly associated with significant individuals related to either the development of the Mount Whitney Power Company or the evolution of SCE. Because much of the physical fabric is not original to the initial development period, resources lack direct physical association with the pioneering founders of the Mount Whitney Power Company. Additionally, there is no indication that they are associated with any notable figures in SCE's twentieth century development.

Under NRHP Criterion C, or CRHR Criterion 3, the Kaweah No. 2 built environment facilities are not reflective of a cohesive design or engineering that merits consideration under this Criterion in relation to individual or district eligibility. As discussed, much of the Kaweah No. 2 system has been reconstructed through the mid-twentieth century to the present, with little engineering fabric that relates to initial development. As such, extant elements of the system exist as an amalgam of materials and design, with

insufficient integrity of materials, workmanship, design, feeling, and association to convey cohesive engineering or design themes under Criterion C.

Lastly, under Criterion D, or CRHR Criterion 4, information potential is limited as most materials do not date to any significant development periods. As such, it is unlikely that resources would convey information regarding hydroelectric construction techniques that is not readily available in the archival record.

Kaweah No. 3 Development

Consistent with the 1989 NRHP evaluation, the updated analysis finds that built environment resources associated with the Kaweah No. 3 development appear to be eligible for listing in the NRHP and CRHR individually and as contributors to the Kaweah No. 3 Hydroelectric System Historic District under Criteria A and C (CRHR Criteria 1 and 3) (summarized in Table CUL 5-5). Constructed by the Mount Whitney Power Company in 1913 as the final component of the Kaweah Hydroelectric System, Powerhouse No. 3 and its associated diversion and water conveyance facilities were representative of both a maturing Mount Whitney Power Company and a rapidly advancing utility industry as a whole, with the design and engineering of this era of the system representative of important advances in hydroelectric development. In addition to this overall historical and engineering significance, built environment resources associated with Kaweah No. 3 retain strong physical and operational integrity—with contributing facilities readily conveying their historical associations through their physical fabric and operational design. The powerhouse, two diversions, multi-component water conveyance flowline, and storage forebay all retain strong integrity of materials, workmanship, design, location, setting, feeling, and association that serves to convey their historical associations as an intact and integrated early twentieth century hydroelectric system (Map CUL 5-1).

Table CUL 5-5 Updated NRHP Status of Built Environment Resources Associated with the Kaweah No. 3 Development

Resource Name	Construction Date	Previous NRHP Evaluation Status	Updated NRHP Evaluation Status
Kaweah No. 3 Powerhouse and Penstock	1913	2D2; 2S2	2D2
Marble Fork Diversion Dam	1913	6Y	3D (Appears eligible for the NRHP as a contributor to a NR district through survey evaluation)
Marble Fork Flowline and Siphon	1913	2D2	2D2
Middle Fork Diversion Dam	1913	6Y	3D
Middle Fork / Kaweah No. 3 Flowline	1913; 1946	2D2	2D2
Kaweah No. 3 Forebay	1913; 2012	2D2	2D2

Under Criterion A, CRHR Criterion 1, the Kaweah No. 3 Hydroelectric System Historic District is associated with the significant Tulare County developments of the Mount Whitney Power Company, which transformed the region through their advancement of pump irrigation and provided a model for the utility industry that demonstrated the immense importance of the agricultural market in hydroelectric development. Prior to Mount Whitney Power Company’s development of the Kaweah Project, the nascent hydroelectric industry had focused largely upon urban and industrial development, with the earliest projects seeking to connect California’s growing urban sphere. In contrast to this emphasis, the Kaweah System developed by Mount Whitney focused almost exclusively upon agriculture, stemming from the belief that California’s Mediterranean Valley climate could be transformed through systematic application of electrically pumped water. By the 1910s, this pioneering effort had transformed swaths of

the San Joaquin Valley and permeated the business plans of the hydroelectric industry, with leading companies including SCE, PG&E, San Joaquin Light and Power Company, and others incorporating the agricultural market as a vital component of their consumer portfolio.

Under NRHP Criterion C, CRHR Criterion 3, the contributors of the Kaweah No. 3 Hydroelectric System Historic District are significant material representatives of 1910s hydroelectric engineering. In contrast to the earlier Powerhouse No. 1 and No. 2, Powerhouse No. 3 was designed as a substantial reinforced concrete classical powerhouse, evoking both the increased stature of the company and the heightened design sensibilities of the industry as a whole. By 1913, hydroelectric construction had acquired a far more advanced stylistic form, with powerhouses increasingly designed to evoke stability and civilizing forces through their architectural form. While Mount Whitney Power Company's Powerhouse No. 3 was spare and restrained in its design and modest in comparison to other notable developments during the period, the building conveys this important stylistic advancement. Similarly, the system's diversions and flowlines are representative of important innovations in water diversion and conveyance. The interconnected Marble Fork and Middle Fork Flowlines represented an increasingly complex conveyance engineering, with the waters of the Marble and Middle Forks intermingled through the placement of a comingling siphon and the flowlines constructed of jointed concrete panels for much of the alignment. This innovative concrete construction was a notable departure from the wood flumes developed in earlier eras and is representative of both improved concrete engineering and improved construction capacity, with all concrete developed in the field through an intensive process of site hauling and staging.

While the Kaweah No. 3 Hydroelectric System Historic District appears eligible under NRHP Criteria A and C, CRHR Criteria 1 and 3, it does not appear to be eligible under Criterion B or D. The district's significance does not stem from direct associations with significant individuals, with its significance instead derived from the agriculturally focused developments of the Mount Whitney Power Company and its hydroelectric design—both of which are better encapsulated under Criteria A and C. Under Criterion D, the contributing resources of the district are well documented in archival literature and engineering documentation and it does not appear that the resources have the potential to provide additional important information in this regard.

All contributing components of the district retain strong physical integrity in relation to all aspects of integrity recognized by the NRHP. The system retains strong integrity of *location*, with the contributing resources of the district remaining in the same location and exhibiting the same spatial and operating relationships as developed in the period of significance. The district retains high integrity of *design*, with all contributing resources conveying significant design features, through their physical form, structural and operational plan, and engineering design. Importantly, material alterations and maintenance have generally left key historic period design features in place, including massing, plan, and physical detailing, with contributing resources displaying integrity through their historic period engineering and aesthetic design features. The *setting* of the resources retains strong integrity, with the hydroelectric facilities integrated into the surrounding landscape in a way that reflects continuity of operation and design. The system's *materials* retain high integrity to the period of significance. The powerhouse was primarily constructed of concrete and steel; flowlines of concrete ditch and buttressed concrete panels; and dams of concrete, rock, and steel. In most senses, the bulk of this original material remains, with only modest alterations to that which was initially developed. The District's complex integration within the framing natural environment conveys a strong sense of *workmanship* that retains high integrity. The Project was designed to harness natural forces related to hydrology and environmental terrain to generate electricity. This energy transfer was accomplished by strategically placed diversions, flowlines, and a lower elevation powerhouse, which together continue to convey a sense of industrial workmanship in relation to this overall task. Lastly, because the Kaweah No. 3 development has continued to operate in much the same manner as it was designed with much of the same materials, the district readily conveys significance through strong integrity of *feeling* and *association*. Through this overall physical integrity, contributing elements of the district convey a strong sense of time and place and illustrate the system's significant themes of development.



FERC PROJECT NO. 298

Map CUL 5-1

Kaweah No. 3 Hydroelectric System NRHP Historic District Boundary

Projection: UTM Zone 11
Datum: NAD 83

Southern California Edison (SCE) has no reason to believe that there are any inaccuracies or defects with information incorporated in this work and make no representations of any kind, including, but not limited to, the warranties of merchantability or fitness for a particular use, nor are any such warranties to be implied, with respect to the information or data, furnished herein. No part of this map may be reproduced or transmitted in any form or by any means, electronic or mechanical, including photocopying and recording system, except as expressly permitted in writing by SCE.

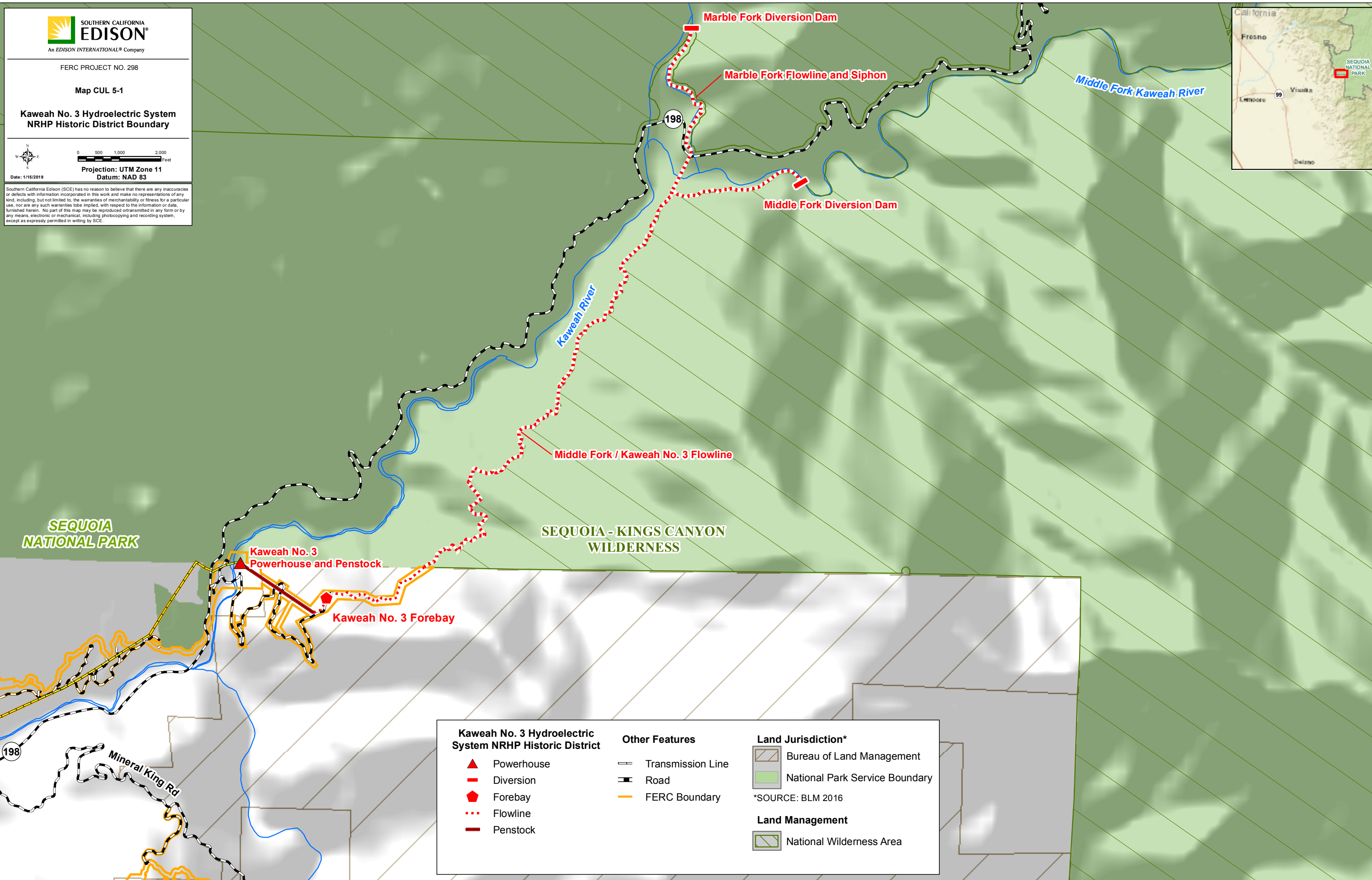

Kaweah No. 3 Hydroelectric System NRHP Historic District	Other Features	Land Jurisdiction*
Powerhouse	Transmission Line	Bureau of Land Management
Diversion	Road	National Park Service Boundary
Forebay	FERC Boundary	*SOURCE: BLM 2016
Flowline		Land Management
Penstock		National Wilderness Area

This Page Intentionally Left Blank

The Kaweah No. 3 Hydroelectric System Historic District retains a spectrum of key physical features, spatial relationships, and operational linkages that enable the district to convey significance as a 1910s hydroelectric development. The character defining features of the district are summarized below, with detailed character defining features for all contributing resources detailed on the District DPR 523 Form in Appendix B.

- Cohesive functional and operational linkages between hydroelectric resources.
- A surrounding terrain that is characterized by mountainous exposures, forested hillsides, and a generally rugged, undeveloped surrounding landscape context.
- An engineering and operational plan that is characterized by substantial distances between resources and a linear operational relationship that extends from the diversion facilities to the Kaweah No. 3 Powerhouse.
- A range of industrial property types, including diversions, a siphon, interconnected flowlines, a forebay, and the powerhouse and penstock that exhibit differing materials, massing, and structures but are bound by a common operating framework.
- A powerhouse design and form that fuses industrial mandates with key architectural allusions in the Classical Revival style.
- Project features that are deeply integrated to surrounding landscape, with diversions conforming to the river channels, flowlines following natural contours, and the powerhouse and penstock placement relating to the vertical distance of the framing hillside.

While the previous evaluation found that the Kaweah No. 3 Powerhouse was individually eligible in addition to being eligible as a contributor to the Kaweah No. 3 Hydroelectric System Historic District, this documentation finds that the building's significance is better conveyed through its district associations and that the resource does not appear to be individually eligible. In and of itself, the powerhouse is representative of a modest design and engineering that was not ground-breaking in its individual form or capacity. The powerhouse's turbines, generators, penstocks, and transmitting voltage were all in keeping with established norms of the period and do not convey any singular advances in operational design. Similarly, while the general classic overtones of the building represented an advance for Mount Whitney Power Company, they are not reflective of significant design advance, with concurrent construction, most notably PLPC's Big Creek No. 1 and No. 2 on the San Joaquin River, far more advanced in their design sensibilities. Within this larger context, the significance of the Kaweah No. 3 Powerhouse is its contributing role within the context of the Kaweah No. 3 development, which was constructed as a cohesive and interrelated water conveyance and generation system that diverted the waters of the Marble and Middle Forks of the Kaweah River for the region's growing agricultural consumption.

Lastly, while the previous evaluation found that the Marble and Middle Fork Diversion Dams did not contribute to the significance of the Kaweah No. 3 Hydroelectric System Historic District, this updated evaluation finds that the two diversion dams do contribute to the significance of the district through their functional design and development associations. The dams are an instrumental part of the operational system, acting as the conveyance entry point for flows that ultimately reach the powerhouse turbines. While they have been subject to limited concrete repair and maintenance, both dams are able to convey their significant associations through their intact physical form, as described in detail in Section 5.4.1.

Built Environment Resources Associated with General Project Operations

The Project includes two classes of historic period general support components that were documented and evaluated for NRHP and CRHR eligibility. These support components are identified in Table CUL 5-6 and documented in detail in Appendix B.

Table CUL 5-6 NRHP Status of Built Environment Resources Associated with General Project Operations

Resource Name	Construction Date	Previous NRHP Evaluation Status	Updated NRHP Evaluation Status
Kaweah Hydroelectric Project Stream Gages	1952-2005	Unevaluated	6Z
Kaweah Transmission Lines: <ul style="list-style-type: none"> • Kaweah No. 3 Powerhouse to Three Rivers Substation • Kaweah No. 1 Tap Line • Kaweah No. 2 Tap Line Kaweah Distribution and Fiber Lines	1913; replacement ongoing with most recent circa 2012	Unevaluated	6Z

The first class of resources consists of eight Project Stream Gages, which are dispersed throughout the Project to measure and record flows. While only one of these gages dates to the historic period, Gage 201, as a class of general support resources this property type appears ineligible for listing in the NRHP or CRHR under any of the criteria for listing. As a whole, the gages are standardized in construction and function and are regularly replaced and upgraded as monitoring requirements and technological upgrades dictate. Under Criterion A, CRHR Criterion 1, the gages are general utility support features that are not emblematic of or associated with significant late nineteenth or early twentieth century development of the Project. Under Criterion B, CRHR Criterion 2, they are not associated with significant individuals in either Mount Whitney Power Company's or SCE's development. Under Criterion C, CRHR Criterion 3, they are standardized in plan and entirely lack historic fabric that dates to any period of significance. Lastly, under Criterion D, CRHR Criterion 4, the gages are a well-documented utility type that possesses low information potential beyond their water gaging records.

The second class of resources consist of Project transmission, distribution, and fiber lines, which are dispersed throughout the Kaweah Project to transmit generated power from the Project and support Project operations. As a class of general support resources this property type appears ineligible for listing in the NRHP or CRHR under any of the criteria for listing. As a whole, the transmission, distribution, and fiber lines are standardized in construction and function and are regularly replaced and upgraded for continued operation, with appurtenant features including poles, conductors, and control switches ranging in age and materials from the mid-twentieth century to the 2010s. Under Criterion A, CRHR Criterion 1, the transmission, distribution, and fiber lines are general utility support features that are not emblematic of or associated with significant late nineteenth or early twentieth century development of the Project. Under Criterion B, CRHR Criterion 2, they are not associated with significant individuals in either Mount Whitney Power Company's or SCE's development. Under Criterion C, CRHR Criterion 3, they are standardized in plan and design. As initially developed, the transmission lines were wood pole lines that typified the era in which they were constructed with both the initial voltage for the Project and the transition to 66 kV not representative of innovative transmission capacities. Further, all original material that dates to the late nineteenth or early twentieth century has been replaced, with all extant towers and poles modern in materials. Lastly, under Criterion D, CRHR Criterion 4, this type of resource is a well-documented utility type that possesses low information potential related to transmission design or construction.

This evaluation of this property type is in keeping with evaluation standards developed for SCE transmission, subtransmission, and distribution property types, which delineates evaluation procedures and generally excludes wood pole transmission lines from NRHP or CRHR consideration.⁴³

⁴³ Historic-Era Electrical Infrastructure Management Program," drafted by Southern California Edison Company, August 2015, 86-91

6 CONCLUSIONS

6.1 Findings

The Project APE includes 18 historic period resources, some of which are multi-component with multiple related built environment building, structures, or objects. These eighteen historic period resources are referred to herein as the Survey Population. Of these, sixteen resources had been previously inventoried and evaluated for NRHP eligibility as part of previous relicensing efforts, with four of the resources determined eligible as contributing components of the Kaweah No. 3 Hydroelectric System Historic District, portions of which are located outside of the FERC Project boundary in the SNP: the Kaweah No. 3 Powerhouse and Penstock, Marble Fork Flowline and Siphon, Middle Fork Flowline / Kaweah No. 3 Flowline, and the Kaweah No. 3 Forebay. The remaining 12 previously documented historic period resources were determined to be ineligible for listing in the NRHP because of a lack of integrity to the original design. SHPO concurred with all findings of this analysis in a letter dated March 21, 1990 (Ref: FERC890210A).

Because of the length of time that has passed since this previous recordation, and the fact that the recordation did not formally inventory and evaluate some components of the Project because at the time the facilities were not yet 50 years of age, this inventory provided an updated NRHP evaluation to account for all historic period built environment resources in the Survey Population. This analysis found that the following six resources appear to be eligible for the NRHP as contributors to the Kaweah No. 3 Hydroelectric System Historic District:

- Kaweah No. 3 Powerhouse and Penstock
- Marble Fork Diversion Dam
- Marble Fork Flowline and Siphon
- Middle Fork Diversion Dam
- Middle Fork/Kaweah No. 3 Flowline
- Kaweah No. 3 Forebay

The remaining 12 historic period resources were inventoried and evaluated and do not appear eligible for listing in the NRHP because of either a lack of significance under any of the criteria for listing or a general lack of material integrity to convey any potential significance.

6.2 Continuing Documentation Efforts

This TSR is a component of CUL 1 – TSP, which was developed to study the effect of the Project on prehistoric and historic-era cultural resources and historic properties. The TSP is intended to assist the Licensee in developing cultural resource management practices and methods to avoid and minimize any adverse effects associated with ongoing management of the Project. Adverse effects could include, but are not limited to, alteration or removal of contributing hydroelectric features, upgrade, or rehabilitation of hydroelectric features, and placement of new features in the vicinity of contributing features. At the time of this writing, the Licensee is not proposing any additions or changes to Project facilities or operations, and as such there are no identified adverse effects associated with the relicensing. As a component of the Study Plan, the Licensee is developing a Draft Historic Properties Management Plan (HPMP) that will be included in the License Application for the Project and finalized in consultation with cultural stakeholders. The HPMP will update the existing Cultural Resource Management Plan (CRMP) and provide a framework for avoiding any potential adverse effects that may arise as part of ongoing operations under the new License.

7 LITERATURE CITED

- Association of Engineering Societies. 1905. "Hydroelectric Power Development and Transmission in California." Published March. Vol. XXXIV, No. 3.
- Engineering News. 1899. "The Mount Whitney Water Power Electric Plant and Light Regulating Device." Vol. XLII, No. 10. 151.
- Heinrich, Darrell W. 2002. "Mill Creek No. 1: Pioneering Commercial Electric Power". *Hydro Review*. Published October.
- Hughes, Thomas P. 1958. "An Incident in the AC-DC Controversy." *The Business History Review*. Vol. 32, No. 2.
- Hughes, Thomas P. 1983. *Networks of Power: Electrification in Western Society 1880-1930*. Johns Hopkins University Press. Baltimore, Maryland.
- Journal of Electricity, Power, and Gas. 1912. "Use of Electricity for Irrigation on the Farm." Published June 29. Volume XXX, No. 14.
- Journal of Electricity, Power, and Gas. 1913. "System of the Mount Whitney Power Company." Published December 27. Volume XXXI, No. 26.
- Journal of Electricity. 1921. "Applying the Self-Interest Story." Published January 1. Volume 46, No. 1.
- Lehman, Susan C., and James C. Williams, Robert A. Hicks, and Clinton M. Blount. 1989. *A History and Significance Evaluation of the Kaweah Hydroelectric System, Tulare County, California*. Submitted to the Environmental Affairs Division of SCE.
- Lewis, B.J., J.M. Cimbala, and A.M. Wouden. 2014. "Major Historical Developments in the Design of Water Wheels and Francis Hydroturbines." Paper presented at the IOP Conference Series: Earth and Environmental Science. Available at <http://iopscience.iop.org/article/10.1088/1755-1315/22/1/012020/pdf>
- McKee, Earl A. Jr., Gaynor B. McKee, and Carol Nadine McGrew. 2017. *Echoes of Three Rivers: Landmarks and Lore*. Kaweah Echoes Press. Spokane, Washington.
- Meyers, William. 1947. *Iron Men and Copper Wires, A Centennial History of the Southern California Edison Company*. Trans-Anglo Books. Glendale, California.
- Pacific Rural Press. 1899. "Cultivation and Irrigation." Published May 13. 129.
- Pacific Rural Press. 1914. "Water Development in Tulare County." Published March 21. 365.
- Southern California Edison Company (SCE). 2015. "Historic-Era Electrical Infrastructure Management Program," unpublished document drafted by SCE.
- The Telegraphic Journal and Electrical Review. 1885. "Electricity in the United States." Published July 4.
- Visalia Times. 1899. "Kaweah Hydroelectric Development." Published June 29.
- Wetzler, Joseph. 1890. "The Electric Railway of Today." *Scribner's Magazine*. Published April.
- Williams, James C. 1996. "California's First High-Head Turbine Installation." Published in *The Journal of the Society for Industrial Archaeology*, Vol. 22, No. 1.
- Williams, James C. 1997. *Energy and the Making of Modern California*. The University of Akron Press. Akron, Ohio.

APPENDIX A

Architectural Area of Potential Effects (APE)

This Page Intentionally Left Blank



0 500 1,000 2,000
Feet

Projection: UTM Zone 11
Datum: NAD 83

Southern California Edison (SCE) has no reason to believe that there are any inaccuracies or defects with information incorporated in this work and make no representations of any kind, including, but not limited to, the warranties of merchantability or fitness for a particular use, nor are any such warranties to be implied, with respect to the information or data, furnished herein. No part of this map may be reproduced or transmitted in any form or by any means, electronic or mechanical, including photocopying and recording system, except as expressly permitted in writing by SCE.

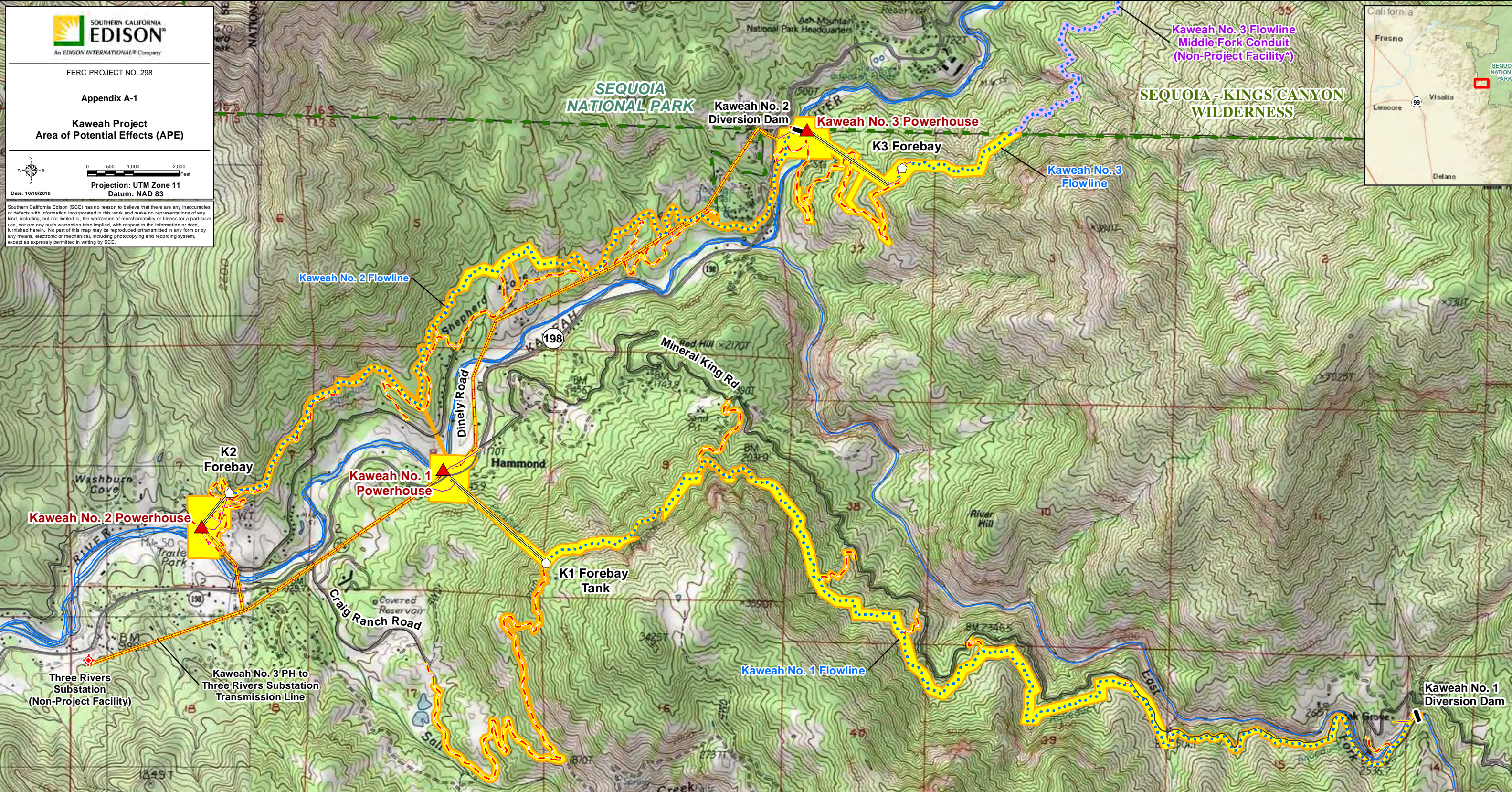

<p>Facilities</p> <ul style="list-style-type: none"> Powerhouse Diversion Utility Forebay Flowline Penstock Transmission Line Project Road Project Trail Communication / Powerline FERC Boundary 		<p>Land Jurisdiction*</p> <ul style="list-style-type: none"> National Park Service <p><small>*SOURCE: BLM 2016</small></p> <p>Land Management</p> <ul style="list-style-type: none"> National Wilderness Area 		<p>Cultural Resource Study</p> <ul style="list-style-type: none"> Area of Potential Effects 		<p>Historic Period Built Environment Hydroelectric Features in Sequoia National Park</p> <ul style="list-style-type: none"> Diversion Dam Flowline 	
---	--	---	--	--	--	---	--

NOTE: Non-FERC Project Facilities in Sequoia National Park (Marble Fork Diversion Dam and Conduit, Middle Fork Diversion Dam and Conduit, Kaweah No. 3 Flowline, and Mineral King Lakes) will be documented as part of the built environment survey population to account for Kaweah Hydroelectric System Historic District contributing resources outside of FERC jurisdiction.

This Page Intentionally Left Blank



0 500 1,000 2,000
Feet

Projection: UTM Zone 11
Datum: NAD 83

Southern California Edison (SCE) has no reason to believe that there are any inaccuracies or defects with information incorporated in this work and make no representations of any kind, including, but not limited to, the warranties of merchantability or fitness for a particular use, nor are any such warranties to be implied, with respect to the information or data, furnished herein. No part of this map may be reproduced or transmitted in any form or by any means, electronic or mechanical, including photocopying and recording system, except as expressly permitted in writing by SCE.

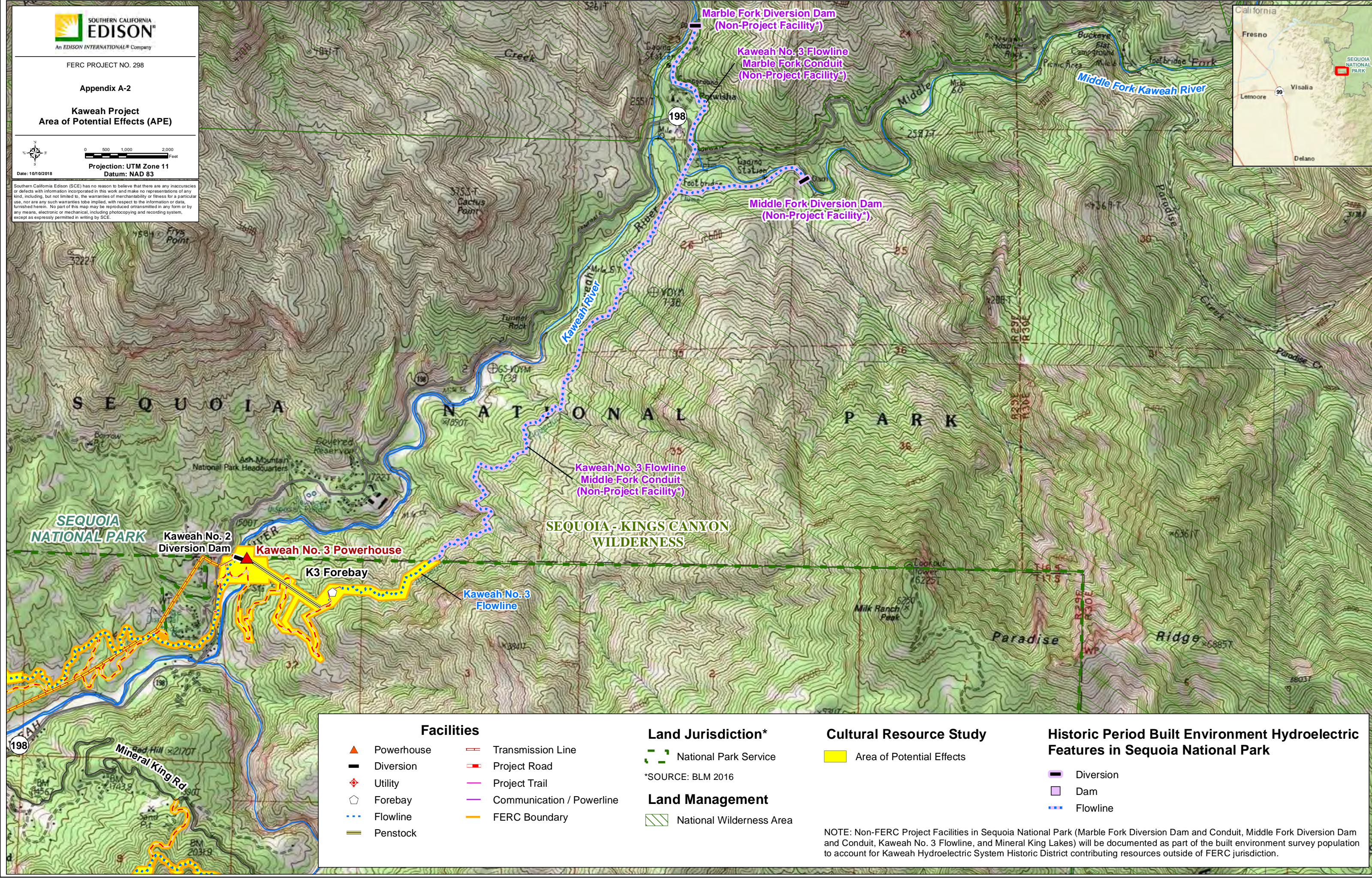

<p>Facilities</p> <ul style="list-style-type: none"> ▲ Powerhouse ▬ Diversion ⬢ Utility ◻ Forebay - - - Flowline ▬ Penstock ▬ Transmission Line ▬ Project Road ▬ Project Trail ▬ Communication / Powerline ▬ FERC Boundary 		<p>Land Jurisdiction*</p> <ul style="list-style-type: none"> - - - National Park Service <p><small>*SOURCE: BLM 2016</small></p> <p>Land Management</p> <ul style="list-style-type: none"> ▨ National Wilderness Area 	<p>Cultural Resource Study</p> <ul style="list-style-type: none"> ▭ Area of Potential Effects 	<p>Historic Period Built Environment Hydroelectric Features in Sequoia National Park</p> <ul style="list-style-type: none"> ▬ Diversion ▭ Dam - - - Flowline
--	--	---	--	--

NOTE: Non-FERC Project Facilities in Sequoia National Park (Marble Fork Diversion Dam and Conduit, Middle Fork Diversion Dam and Conduit, Kaweah No. 3 Flowline, and Mineral King Lakes) will be documented as part of the built environment survey population to account for Kaweah Hydroelectric System Historic District contributing resources outside of FERC jurisdiction.

This Page Intentionally Left Blank

Southern California Edison (SCE) has no reason to believe that there are any inaccuracies or defects with information incorporated in this work and make no representations of any kind, including, but not limited to, the warranties of merchantability or fitness for a particular use, nor are any such warranties to be implied, with respect to the information or data furnished herein. No part of this map may be reproduced or transmitted in any form or by any means, electronic or mechanical, including photocopying and recording system, except as expressly permitted in writing by SCE.



<p>Facilities</p> <ul style="list-style-type: none"> ▲ Powerhouse ▬ Diversion ⬢ Utility ◊ Forebay ⋯ Flowline ▬ Penstock ▬ Transmission Line ▬ Project Road ▬ Project Trail ▬ Communication / Powerline ▬ FERC Boundary 		<p>Land Jurisdiction*</p> <ul style="list-style-type: none"> ▬ National Park Service <p>*SOURCE: BLM 2016</p> <p>Land Management</p> <ul style="list-style-type: none"> ▬ National Wilderness Area 		<p>Cultural Resource Study</p> <ul style="list-style-type: none"> ▬ Area of Potential Effects 		<p>Historic Period Built Environment Hydroelectric Features in Sequoia National Park</p> <ul style="list-style-type: none"> ▬ Diversion ▬ Dam ⋯ Flowline 	
--	--	--	--	---	--	--	--

NOTE: Non-FERC Project Facilities in Sequoia National Park (Marble Fork Diversion Dam and Conduit, Middle Fork Diversion Dam and Conduit, Kaweah No. 3 Flowline, and Mineral King Lakes) will be documented as part of the built environment survey population to account for Kaweah Hydroelectric System Historic District contributing resources outside of FERC jurisdiction.

This Page Intentionally Left Blank

APPENDIX B

Department of Parks and Recreation (DPR) Forms

This Page Intentionally Left Blank

State of California - The Resources Agency
DEPARTMENT OF PARKS AND RECREATION
PRIMARY RECORD

Primary #
HRI #
Trinomial
NRHP Status Code

Other Listings _____
Review Code _____ Reviewer _____ Date _____

Page 1 of 199 *Resource Name or #: (Assigned by recorder) Kaweah Hydroelectric Project, FERC Project No. 298

*P2. Location: Not for Publication Unrestricted *a. County Tulare

and (P2c, P2e, and P2b or P2d. Attach a Location Map as necessary.)

*b. USGS 7.5' Quad Kaweah; Case Mountain; Giant Forest Date 1987; 1986; 1987

c. Address: 44511 Sierra Drive City Three Rivers, CA Zip 93271

d. UTM: (Give more than one for large and/or linear resources) Zone __, _____ mE/ _____ mN

e. Other Locational Data: (e.g., parcel #, directions to resource, elevation, decimal degrees, etc., as appropriate)

Project Administrative Address: P2. See accompanying DPR 523 A for location of each Project Facility documented.

*P3a. Description: (Describe resource and its major elements. Include design, materials, condition, alterations, size, setting, and boundaries)

This recordation documents hydroelectric facilities associated with Southern California Edison Company's (SCE) Kaweah Hydroelectric Project, Federal Energy Regulatory Commission (FERC) Project No. 298. Documented resources include 18 buildings and structures associated with the FERC Hydroelectric Project constructed between 1898 and 2002. This documentation provides an overall description of the operating hydroelectric system, develops a historic context relating to the development of the hydroelectric system as a whole, and includes a National Register of Historic Places (NRHP) and California Register of Historical Resources (CRHR) evaluation for individual and district eligibility for system components. Following this district analysis, individual Primary and Building, Structure, and Object (BSO) Records document each resource in detail.

*P3b. Resource Attributes: (List attributes and codes) HP11 – Engineering structure; HP21 – Dam

*P4. Resources Present: Building Structure Object Site District Element of District Other (Isolates, etc.)

*P5b. Description of Photo: (view, date, accession #) Kaweah No. 3 Powerhouse, facing north, 4/18/2018.



*P6. Date Constructed/Age and Source:

Historic Prehistoric Both
Project facilities constructed between 1898-2002.

*P7. Owner and Address:

SCE
1515 Walnut Grove Avenue
Rosemead, CA 91770

*P8. Recorded by: (Name, affiliation, and address)

Matt Walker and Polly Allen
Cardno, Inc.
2890 Gateway Oaks Dr., Suite 200
Sacramento, CA 95833

*P9. Date Recorded:

April 16-19, May 7-9, 2018

*P10. Survey Type: (Describe)

Intensive

*P11. Report Citation: (Cite survey report and other sources, or enter "none.")

CUL-1: Built Environment Technical Study Report, Kaweah Hydroelectric Project, FERC Project No. 298, January 2019

*Attachments: None Location Map Continuation Sheet Building, Structure, and Object Record

Archaeological Record District Record Linear Feature Record Milling Station Record Rock Art Record

Artifact Record Photograph Record Other (List):

Page 2 of 199

*NRHP Status Code:

***Resource Name or # (Assigned by recorder)**

D1. Historic Name: Kaweah Hydroelectric Project D2. Common Name: Kaweah Hydroelectric Project, FERC Project No. 298: Kaweah No. 3 Hydroelectric System Historic District

***D3. Detailed Description** (Discuss overall coherence of the district, its setting, visual characteristics, and minor features. List all elements of district.):

The Kaweah Hydroelectric Project includes three operationally interrelated hydroelectric developments: Kaweah No. 1, Kaweah No. 2, and Kaweah No. 3, which commenced operation in June 1899, February 1905, and May 1913, respectively. The three developments include 18 facilities, including associated diversion structures, water conveyance structures, powerhouses, and transmission lines. The 18 project-related facilities documented herein are listed in **Table 1** on the District Continuation Sheet.

The purpose of this District Record is to document all facilities associated with the Hydroelectric Project, develop a historic context for the Project as a whole, and evaluate all components of the Project for both district and individual NRHP eligibility. Based on the evaluation herein, analysis concludes that select portions of the Kaweah Hydroelectric Project contribute to an NRHP and CRHR Historic District: The Kaweah No. 3 Hydroelectric System Historic District. Contributors to the district are listed in **Table 2** on the District Continuation Sheet and are discussed in further detail herein. No other Kaweah Hydroelectric Project facilities appear individually eligible for the NRHP or CRHR or to contribute to a historic district because of a lack of integrity, as discussed on the District Continuation Sheets and Primary and BSO Sheets addressing each facility.

***D4. Boundary Description** (Describe limits of district and attach map showing boundary and district elements.):

The NRHP and CRHR eligible Kaweah No. 3 Hydroelectric System Historic District identified in this recordation is a contiguous hydroelectric district delineated by the functional and operational layout of the storage, conveyance, and generation features of the Kaweah No. 3 hydroelectric development. Descending from the uppermost elevation, the Kaweah No. 3 Hydroelectric System Historic District boundary includes the following facilities: Marble Fork Diversion Dam, Middle Fork Diversion Dam, Marble Fork Flowline and Siphon, Middle Fork/Kaweah No. 3 Flowline, Kaweah No. 3 Forebay, Kaweah No. 3 Powerhouse and Penstock. No other Kaweah Project Facilities documented herein contributes to this District. See Map of the identified Kaweah No. 3 Hydroelectric System Historic District on the District Continuation Sheet.

***D5. Boundary Justification:**

The boundary of the Kaweah No. 3 Hydroelectric System Historic District includes all hydroelectric diversion, conveyance, and generation features of the Kaweah No. 3 hydroelectric development that were developed in 1913 by the Mount Whitney Power Company. The facilities that define this boundary retain integrity and convey significant physical associations and historic themes associated with Mount Whitney Power Company's early twentieth century hydroelectric development.

D6. Significance: Theme Engineering **Area** Tulare County, California **Period of Significance** 1913-1916

Applicable Criteria A and C (Discuss district's importance in terms of its historical context as defined by theme, period of significance, and geographic scope. Also address the integrity of the district as a whole.)

SCE's Kaweah No. 3 Hydroelectric System Historic District appears to meet the criteria for listing in the NRHP and the CRHR. The property has been evaluated in accordance with Section 106 of the National Historic Preservation Act (NHPA) as well as Section 15064.5(a)(2)-(3) of the California Environmental Quality Act Guidelines (CEQA), using the criteria outlined in Section 5024.1 of the California Public Resources Code, and appears to be a historic property and historical resource. See District Continuation Sheets for full historic context and NRHP and CRHR evaluation.

***D7. References** (Give full citations including the names and addresses of any informants, where possible.):

SCE Facility Records, Huntington Library, Three Rivers Historical Society. See footnotes for detailed references.

***D8. Evaluator:** Polly Allen and Matt Walker **Date:** December 2018

Affiliation and Address:

Cardno, Inc.
2890 Gateway Oaks Drive, Suite 200
Sacramento, CA 95833

*Resource Name or # (Assigned by recorder)

D1. Historic Name: Kaweah Hydroelectric Project D2. Common Name: Kaweah Hydroelectric Project, FERC Project No. 298: Kaweah No. 3 Hydroelectric System Historic District

D3. Detailed Description (Continued):

Built environment resources associated with SCE's Kaweah Hydroelectric Project are located on the Kaweah River and East Fork Kaweah River near the community of Three Rivers in Tulare County, California. The Project is located on private lands and public lands administered by the Bureau of Land Management (BLM). The Project also utilizes non-FERC Project diversions and flowlines located within the Sequoia National Park (SNP) operated under a Special Use Permit (SUP) issued by the National Park Service (NPS). The resources date from 1898 to 2002 and relate to the construction and ongoing operation of the Kaweah Hydroelectric Project, initially conceived and constructed by the Mount Whitney Power Company and owned and operated by SCE from 1920 to the present. The 18 Project facilities associated with the Kaweah Hydroelectric Project are listed in **Table 1**, below. The facilities are also documented in detail on accompanying Primary and BSO Records accompanying this District analysis.

Table 1: Kaweah Hydroelectric Project Facilities

Resource Name	Construction Date	NRHP or CRHR Eligible
Kaweah No. 1 Facilities		
Kaweah No. 1 Powerhouse and Penstock	1898; 1928-1929 (original powerhouse replaced)	No
Kaweah No. 1 Diversion Dam	1898; 1940	No
Kaweah No. 1 Flowline	1947 (reconstruction from original 1899 flowline)	No
Kaweah No. 1 Forebay Tank	1947 (reconstruction from original 1899 forebay)	No
Kaweah No. 1 Powerhouse Campus	1927; circa 1950; 1990	No
Mineral King Dams	1903-1905	No
Kaweah No. 2 Facilities		
Kaweah No. 2 Powerhouse and Penstock	1905	No
Kaweah No. 2 Diversion Dam	1905; 1938; 2012-2013	No
Kaweah No. 2 Flowline	1905; 1948; 1984	No
Kaweah No. 2 Forebay	1905; 1946	No
Kaweah No. 3 Facilities		
Kaweah No. 3 Powerhouse and Penstock	1913	Yes
Marble Fork Diversion Dam	1913	Yes
Marble Fork Flowline and Siphon	1913	Yes
Middle Fork Diversion Dam	1913	Yes

*Resource Name or # (Assigned by recorder)

D1. Historic Name: Kaweah Hydroelectric Project D2. Common Name: Kaweah Hydroelectric Project, FERC Project No. 298: Kaweah No. 3 Hydroelectric System Historic District

Resource Name	Construction Date	NRHP or CRHR Eligible
Kaweah No. 3 Facilities (cont'd)		
Middle Fork / Kaweah No. 3 Flowline	1913; 1946	Yes
Kaweah No. 3 Forebay	1913; 2012	Yes
Project Support Facilities		
Kaweah Hydroelectric Project Stream Gages	1952-2005	No
Kaweah Transmission Lines: <ul style="list-style-type: none"> • Kaweah No. 3 Powerhouse to Three Rivers Substation • Kaweah No. 1 Tap Line • Kaweah No. 2 Tap Line • Kaweah Distribution and Fiber Lines 	1913; replacement of pole structures and transmission equipment ongoing with most recent structure replacements in 2012	No

As part of this NRHP and CRHR District documentation, all of the Kaweah Hydroelectric Project facilities in **Table 1** were analyzed for their potential to exhibit significance as either NRHP or CRHR District contributors or individual historic properties / historical resources. The analysis concluded that six of the Kaweah Hydroelectric Project facilities do appear to comprise an NRHP and CRHR Historic District: The Kaweah No. 3 Hydroelectric System Historic District. The six facilities are listed in **Table 2**, below and identified in the Historic District Boundary Map included on the following page. The remaining 12 Project facilities documented herein do not appear to contribute to any NRHP or CRHR historic district or appear to illustrate significant themes under the NRHP or CRHR as individual resources, as described further herein.

Table 2: Kaweah No. 3 Hydroelectric System Historic District Contributors

Resource Name	Construction Date
Kaweah No. 3 Powerhouse and Penstock	1913
Marble Fork Diversion Dam	1913
Marble Fork Flowline and Siphon	1913
Middle Fork Diversion Dam	1913
Middle Fork / Kaweah No. 3 Flowline	1913; 1946
Kaweah No. 3 Forebay	1913; 2012

*Resource Name or # (Assigned by recorder)

D1. Historic Name: Kaweah Hydroelectric Project D2. Common Name: Kaweah Hydroelectric Project, FERC Project No. 298: Kaweah No. 3 Hydroelectric System Historic District

D4. Boundary Description (Continued)

Kaweah No. 3 Hydroelectric System Historic District Overview Boundary Map

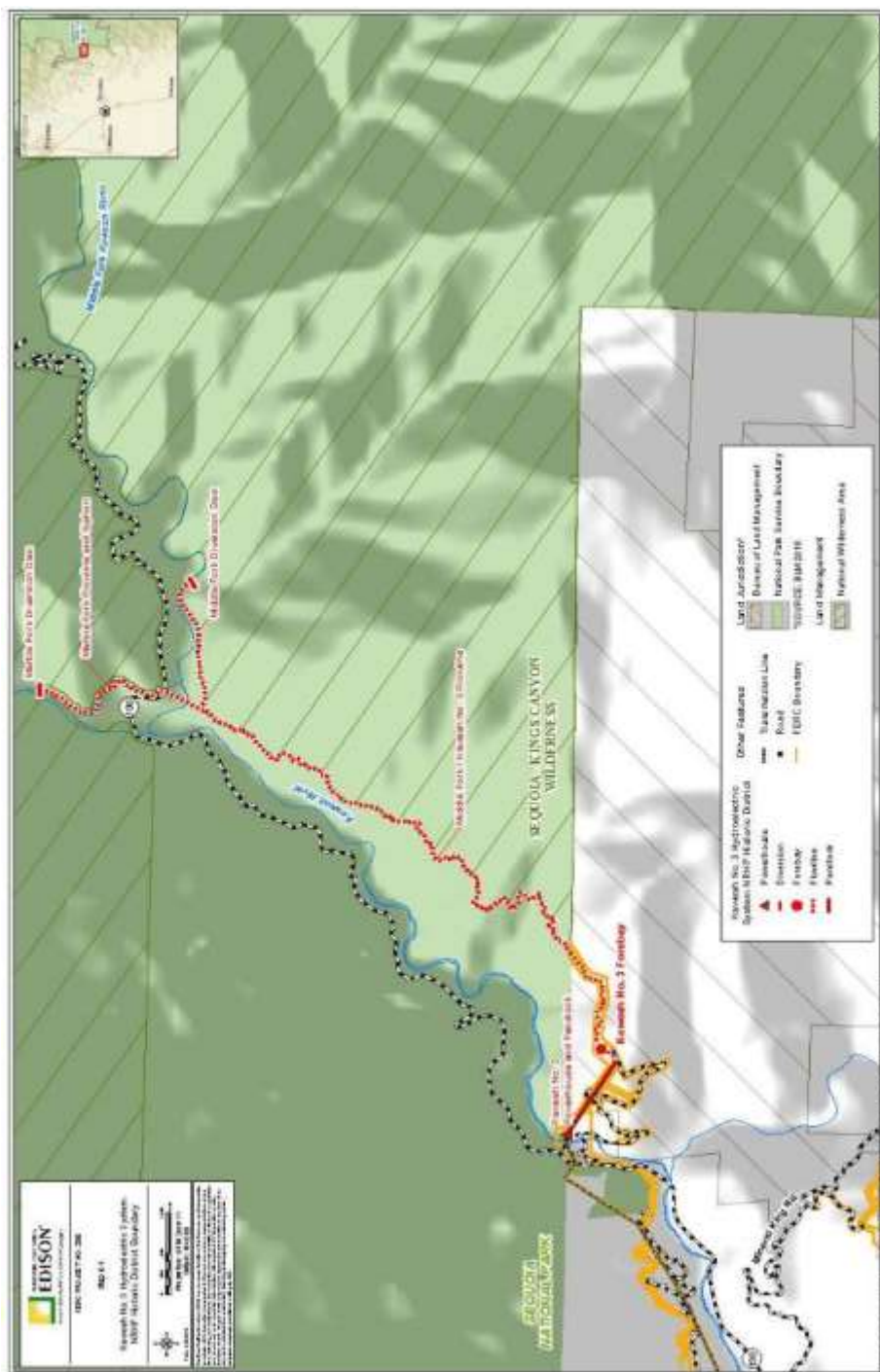

***Resource Name or # (Assigned by recorder)**

D1. Historic Name: Kaweah Hydroelectric Project D2. Common Name: Kaweah Hydroelectric Project, FERC Project No. 298: Kaweah No. 3 Hydroelectric System Historic District

D6. Significance (Continued):

The purpose of this district NRHP and CRHR significance analysis is to develop a historic context relating to the development of the Kaweah Hydroelectric Project as a whole in order to support NRHP and CRHR evaluation for district and individual eligibility for all system components. To this end, the following significance statement develops a comprehensive historic context for the hydroelectric project and includes evaluative analysis for all resources regarding NRHP and CRHR significance and integrity, as defined by the seven aspects of integrity.

Following this district analysis, Primary and Building, Structure, and Object (BSO) Records document each Project facility in detail.

Kaweah Hydroelectric Project Historic Context

Growth of Hydroelectric Capacity in California

By the closing decades of the nineteenth century, the development and consumption of electricity had come to define the possibilities of modernity for both California and the nation. Ushering in a host of modern marvels, including widespread civic and residential lighting, public transportation, industrial and agricultural development, and a radically altered commercial and domestic sphere, the advent of electricity became a singular fixation, transforming the lives of millions in mere decades. In its initial years of popular advancement, however, the nascent industry was defined as much by its constraints as its possibilities, with seemingly intractable physical and technological barriers preventing widespread development and public adoption of electricity. Overcoming these barriers to mass production and consumption became the central theme of early electrical expansion, with engineers, financiers, and an engrossed public marking every advancement with fanfare, pomp, and a seemingly universal conviction of electricity's ultimate transformative power.

In large, California's nineteenth century electrical industry was hampered by two primary material deficiencies, with the first stemming from a paucity of readily exploited fuels. While areas of the state boasted abundant forests, much of the state was devoid of extensive tree cover. In addition, the state lacked critical coal deposits and other readily utilized natural resources, with oil exploration still in relative infancy. As a result, early electrical generation schemes were limited in both scalability and reach, with only isolated, if high profile, municipal success stories involving gas, coal, wood, and other traditional fuel sources.¹

Although California failed in these measures of material abundance, the state's nascent electrical industry soon turned to the vast untapped potential of a seemingly limitless resource of mountain water. In particular, the waters that thundered down the steep flanks of the Sierra Nevada. Unlike the largely flat rivers of the East and Midwest, the rivers of the Sierra Nevada were characterized by widely disseminated watersheds with astonishingly steep descents, with a snowpack that continuously relayed flows to the valleys below via an intricate network of abundant rivers and streams. Within this geographic context, the system presented ideal generation conditions, which required sharp drops and sustained flows to produce hydroelectric power.²

¹ James C. Williams, *Energy and the Making of Modern California*, 168-236.

² James C. Williams, *Energy and the Making of Modern California*, 168-236; James C. Williams, "California's First High Head Turbine Installation," *The Journal of the Society for Industrial Archaeology*, Vol. 22, No. 1, 1996.

*Resource Name or # (Assigned by recorder)

D1. Historic Name: Kaweah Hydroelectric Project D2. Common Name: Kaweah Hydroelectric Project, FERC Project No. 298: Kaweah No. 3 Hydroelectric System Historic District

In many senses, the commercial exploitation of hydro power was not wholly new, and owed much to California's intensive mining era. Primitive hydroelectric systems had emerged from California's mining industry as early as the 1870s, with a number of mines producing sufficient supplies for private use, thereby increasing efficiencies and yield. In addition, the commercial expansion of the hydroelectric industry was founded upon basic mining principles that had been in use for decades, including tunnel driving and hydraulic engineering. The profound shift that vaulted commercial hydroelectric development to the forefront of electrical advancement, however, related to the solution of the state's second material constraint: the development of effective transmission methods over large-scale distances.³

While the towering wall of the Sierra had long been known to present lucrative opportunities for hydro-generation, the great distances separating the mountains from the state's major coastal population centers had always precluded viable statewide development. As late as the 1880s, effective transmission was largely limited to an approximately 10-mile sphere, with available direct current (DC) technologies precluding reliable service delivery outside of an exceedingly limited radius. Solving the transmission puzzle became the defining electrical pursuit of the late nineteenth century, leading to the revolutionary adoption of alternating current (AC) systems, which phased and stepped power along the transmission corridor to conserve and maintain voltage levels. AC experimentation began in Europe in the 1870s, and by the 1890s had proved to be vastly superior to DC current.⁴

By the early 1890s, three-phase AC electrical transmission had been implemented at a number of early hydroelectric plants in California, including Redlands Electric Light and Power Company's Mill Creek Power Plant, the Sacramento Electric Power and Light Company's Folsom Powerhouse, and the San Joaquin Electric Company's Powerhouse No. 1 on the San Joaquin River. At Mill Creek, AC transmission sent 2,400 volts of power 7.5 miles to the City of Redlands; at Folsom, 2 years later, transmission length had jumped to 22 miles, with an output of 11,000 volts; the same year, the San Joaquin Powerhouse sent 11,000 volts 37 miles to Fresno. While these distances and voltages seem modest in scale related to modern applications, they proved revolutionary in establishing the commercial viability of AC hydroelectric generation in California. By 1895, the burgeoning long-distance hydroelectric industry was central to California's conception of future growth, with the San Francisco Call summarizing the phenomenon:

A new kind of hustler has arisen within the past three or four months, he has been rapidly multiplying and filling the earth. He is the promoter of new electrical enterprises, and especially the promoter of schemes for the long-distance transmission of electric power. The air of the whole Pacific Coast has all at once been filled with talk about setting up water wheels in lonely mountain places and making them give light and cheaply turn other wheels in towns miles away.⁵

Thus, by 1900, hydroelectricity had become one of the central tenets of California's physical growth and economic expansion. As chronicled by James C. Williams, a central historian of the development of energy in

³ James C. Williams, *Energy and the Making of Modern California*, 168-236; James C. Williams, "California's First High Head Turbine Installation," *The Journal of the Society for Industrial Archaeology*, Vol. 22, No. 1, 1996.

⁴ Thomas P. Hughes, *Networks of Power: Electrification in Western Society: 1880-1930* (Baltimore: Johns Hopkins University Press, 1983), 278-280.

⁵ Darrell W. Heinrich, "Mill Creek No. 1: Pioneering Commercial Electric Power," *Hydro Review*, October 2002; *San Francisco Call* Article quoted in *Energy and the Making of Modern California*, 177.

*Resource Name or # (Assigned by recorder)

D1. Historic Name: Kaweah Hydroelectric Project D2. Common Name: Kaweah Hydroelectric Project, FERC Project No. 298: Kaweah No. 3 Hydroelectric System Historic District

California, “before the mid-twentieth century, electric power in California meant hydroelectricity,” with energy development and hydroelectric expansion virtually synonymous. With the ready abundance of ideal natural watersheds coupled with the radical strides in AC transmission technology, the state became an ideal proving ground for advancements in the industry, with both engineers and investors flocking to the rapidly evolving arena.⁶

By the 1910s, California led the nation in hydroelectric development, with a number of previously unimaginable mega-projects powering the rapidly growing urban sphere and shaping the Sierra. The projects spanned the state, with major facilities developed in Southern California, most notably Pacific Light and Power Company’s gargantuan Big Creek, as well as the northern reaches of the state, including Pacific Gas and Electric Company’s (PG&E) Pit River Development in Shasta County as well as a host of developments proposed or planned along Northern California’s more abundant mountain waterways. The projects, located in far-flung and little developed mountain areas, utilized the suite of technological principles that had been rapidly perfected over the previous decades, including increasingly efficient turbines, massive improved generators and electrical governing equipment, and, perhaps most critically, newly perfected long-distance transmission technologies. By the early 1920s this widespread technological and physical development had transformed community and economic life across the state and the nation. A 1921 lecture of the San Francisco Electrical Development League succinctly conveyed this radically altered sphere, opining on the centrality of electricity, “Of all the agencies that contribute to the comforts and conveniences of this twentieth century civilization, electricity is undoubtedly the greatest. It enters into nearly every phase of our domestic and business life: transportation, communication, food production and preparation, light, heat, and the production of all of our necessities and luxuries.”⁷

Mount Whitney Power Company: Hydroelectricity and Agricultural Development

Within this context of rapid hydroelectric expansion, the Mount Whitney Power Company emerged as an early electrical innovator in Tulare County, establishing one of the state’s earliest three-phase AC hydroelectric plants on the Kaweah River in the mountains east of Visalia. The hydroelectric project was the brainchild of Ben Maddox, a Tulare County booster who was editor of the Visalia Times and a substantial agricultural landowner, farming 600 acres of plums north of Visalia. Observing the spate of hydroelectric advances that characterized the 1880s and 1890s, Maddox theorized that hydroelectric development could transform Tulare County’s arid dry-farmed lands into a verdant agricultural enclave, allowing farmers to efficiently access a deep wellspring of ground water through pump irrigation and free themselves from the punishing Mediterranean climate cycle. Maddox was well situated to realize his goal, having both a vocal editorial platform in the Visalia Times from which to tout the virtues of electrical irrigation and a cadre of associates who were well versed in the technical and economic development of hydroelectric schemes. By the mid-1890s Maddox was in partnership with William Henry Hammond, a Tulare County Clerk and real estate promoter, and Albert G. Wishon, a fellow real estate promoter with a particular interest in and affinity for agricultural irrigation schemes (**Figure 1**). Initially, the three formed the Kaweah Electric Light and Power Company, securing financing and rights-of-way to develop a hydro plant at the present site of Terminus Dam below Three Rivers. Ultimately this plan

⁶ James C. Williams, *Energy and the Making of Modern California*, 168-236; *Journal of Electricity*, “Applying the Self-Interest Story,” Volume 46, No. 1, January 1, 1921.

⁷ *Journal of Electricity*, “Applying the Self-Interest Story,” Volume 46, No. 1, January 1, 1921.

*Resource Name or # (Assigned by recorder)

D1. Historic Name: Kaweah Hydroelectric Project D2. Common Name: Kaweah Hydroelectric Project, FERC Project No. 298: Kaweah No. 3 Hydroelectric System Historic District

was scrapped; however, as Wishon studied the rapid technological advances of the period and realized the full possibility of high head hydroelectric development further up the Kaweah River. By 1898 the group had reorganized as the Mount Whitney Power Company and construction had begun on the company's first powerhouse in Three Rivers, Kaweah Powerhouse No. 1. Funding for the venture was supplied by William Henry Hammond's brother, John Hays, a London-based mining magnate who joined the three founders as a key financier for the duration of Project development.⁸

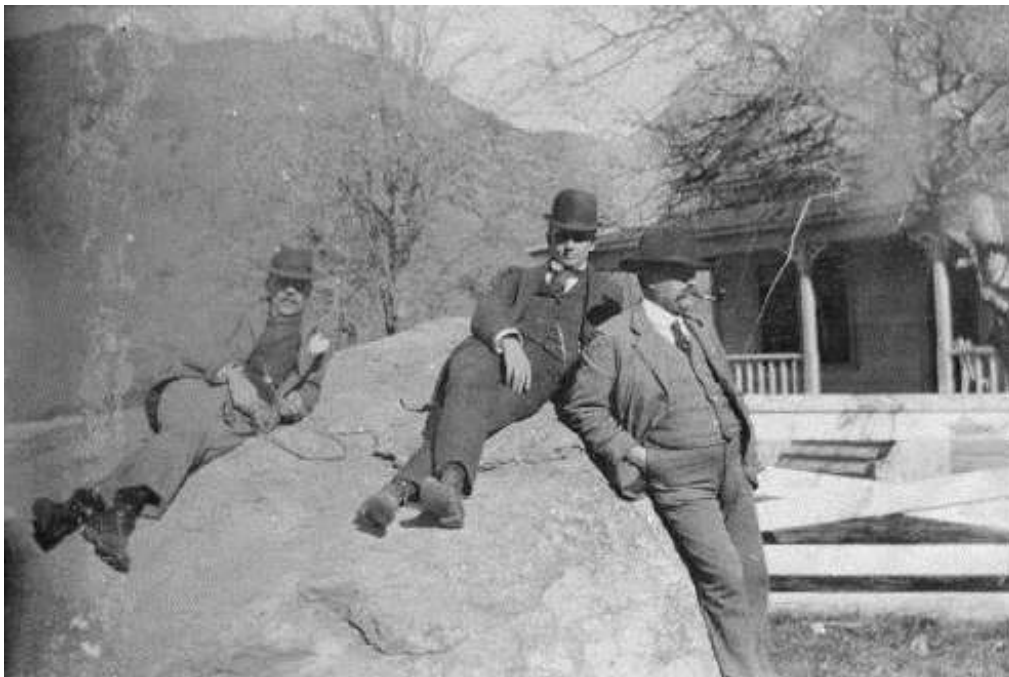

Figure 1: Founders of Mount Whitney Power Company, Hammond, Maddox, Wishon (l-r), ca. 1908
(Huntington Digital Library, Southern California Edison Photograph Collection, Call Number 04 – 00716)

Mount Whitney Power Company was notable in that the company's exclusive focus on agriculture departed markedly from the hydroelectric business model pursued to date. The state's earliest plants, most notably Redlands, Folsom, and San Joaquin, oriented to California's burgeoning cities, supplying electricity for urban lights, streetcars, industry, and a growing array of personal urban consumption. By recognizing and capitalizing on the tremendous market potential of irrigated agriculture, Mount Whitney laid the foundation for a comprehensive campaign of rural and agricultural electrification that characterized the first decades of the twentieth century in California, a campaign that ultimately served to create the intensive irrigated

⁸ Earl A. McKee, Jr., Gaynor B. McKee, and Carol Nadine McGrew, *Echoes of Three Rivers: Landmarks and Lore* (Spokane, WA: Kaweah Echoes Press, 2017), 71-83; "Hydroelectric Power Development and Transmission in California," *Association of Engineering Societies*, Vol. XXXIV, No. 3, March 1905, 8-98.

*Resource Name or # (Assigned by recorder)

D1. Historic Name: Kaweah Hydroelectric Project D2. Common Name: Kaweah Hydroelectric Project, FERC Project No. 298: Kaweah No. 3 Hydroelectric System Historic District

agricultural landscape that defines the state to the present. As recorded in a Journal of Electricity retrospective of the Project in 1913, “The idea of pumping the underground waters for irrigation was a conception originating with this Project. Nowhere else had such a plan been considered feasible.”⁹

By the 1890s, California farmers and real estate promoters were well acquainted with the intractable geographic conundrum that limited the state’s potential. On the one hand, California boasted a premier growing season and climate that allowed for production of virtually any crop. On the other, the state’s climate regime was characterized by penetrating summers with no rain and spiking temperatures—a pattern which precluded extensive cultivation in many sections of the state. Period agricultural publications expressed settler’s frustration—and even dread, as in an 1899 Pacific Rural Press article which lamented, “We are well out of the rainy months and well into the long, dry season. The heat is rising; the sun takes a longer, steadier gaze at our place on the earth’s surface; occasional puffs of hot, dry wind give a foretaste of what soon will be for months to come.” Within this context, successful delivery of water was the key to unwrapping both agricultural plenty and economic growth—as vast tracts of arid land could be transformed to marketable agricultural property. As concluded by the Journal of Electricity, Power, and Gas, “The east half of the San Joaquin Valley of Central California is a vast plain of tillable, productive land, whose potential value manifests itself in the prolific outpourings of its hidden resources only by the application of a constant supply of water...unlocking this has remained for the magic power of electricity to make possible the modern reality of quenching the thirst of this otherwise favored area.”¹⁰

Mount Whitney’s pioneering efforts in electrical irrigation provided an early model for the transformative impact of pump irrigation—providing electricity to large sections of Tulare County and allowing for extensive agricultural expansion and diversification. By the early years of the twentieth century, other electrical concerns followed suite, with virtually all of the state’s nascent electrical companies accessing the agricultural market. In large, this market served as a complement to the steady electrical expansion in the urban realm, with secondary transmission and distribution lines emanating from the major trunk transmission corridors that connected cities such as Los Angeles and San Francisco. By 1909, over 2 million acres of California agricultural land were irrigated. By 1930 this number had risen 2 over 5 million, a number which has continued to expand to the present. By 1920, the total agricultural load of California’s leading electrical companies was reported at nearly 300 MW, almost entirely from California’s hydro systems. This massive increase was largely predicated on the steady expansion of electrical infrastructure, coupled with a drumbeat of marketing and advertising that saturated the state’s agricultural press and real estate marketing channels (**Figure 2**). With the water problem seemingly solved, California was marketed as a veritable Eden—with a mild climate, rich soils, and abundant water supplies that overcame all of the state’s earlier climatic limitations.¹¹

⁹ “Hydroelectric Power Development and Transmission in California,” *Association of Engineering Societies*, Vol. XXXIV, No. 3, March 1905, 8-98; James C. Williams, *Energy and the Making of Modern California*, 218-236; System of the Mount Whitney Power and Electric Company,” *Journal of Electricity, Power, and Gas*, Vol. XXXI, No. 26, December 27, 1913.

¹⁰ “Cultivation and Irrigation,” *Pacific Rural Press*, May 13, 1899; “Use of Electricity for Irrigation on the Farm,” *Journal of Electricity, Power, and Gas*, June 29, 1912; “System of the Mount Whitney Power and Electric Company,” *Journal of Electricity, Power, and Gas*, Vol. XXXI, No. 26, December 27, 1913.

¹¹ “System of the Mount Whitney Power and Electric Company,” *Journal of Electricity, Power, and Gas*, Vol. XXXI, No. 26, December 27, 1913.

*Resource Name or # (Assigned by recorder)

D1. Historic Name: Kaweah Hydroelectric Project D2. Common Name: Kaweah Hydroelectric Project, FERC Project No. 298: Kaweah No. 3 Hydroelectric System Historic District



Figure 2: Promotional Power Brochure, 1920
(*Journal of Electricity, Volume 45, November 15, 1920, 459*)

Physical Development of the Kaweah System

Kaweah No. 1 Development

After securing water rights and rights-of-way between 1896 and 1898, the Kaweah No. 1 Powerhouse and its associated hydroelectric infrastructure were developed in 9 months, with construction beginning in October of 1898 and the plant coming on-line in June of 1899. System components included the powerhouse; a diversion dam on the East Fork of the Kaweah River; an approximately 30,000-foot-long redwood flume conveying water from the diversion to the penstock; and a 3,300-foot-long penstock with a vertical head of 1,300 feet—one of the highest developed to date. Mount Whitney Power Company retained San Francisco Engineer Robert McF. Doble to design all system components. Doble was associated with the San Francisco Abner Doble Company, a family concern that had staked a major claim in the burgeoning hydroelectric development market with their

*Resource Name or # (Assigned by recorder)

D1. Historic Name: Kaweah Hydroelectric Project D2. Common Name: Kaweah Hydroelectric Project, FERC Project No. 298: Kaweah No. 3 Hydroelectric System Historic District

development of improved elliptical water turbines that reduced inefficiencies and problematic bucket wear of the standard Pelton Wheel.¹²

As described by period press, the Kaweah Powerhouse No. 1 was a, “plain but substantial structure,” measuring 30 feet by 50 feet and 20 feet in height. The building was rectangular in plan and was constructed of Oregon pine sheathed in corrugated iron. The spare and utilitarian design was generally reflective of California’s nineteenth century hydro plants, which were limited in their ornamentation and architectural treatment (Figure 3).¹³



Figure 3: Kaweah No. 1 Powerhouse, 1904
(Huntington Digital Library, SCE Photograph Collection, Call Number 04 – 00041)

¹² B.J. Lewis, J.M. Cimbala, A.M. Wouden, “Major Historical Developments in the Design of Water Wheels and Francis Hydroturbines,” paper presented at the IOP Conference Series: Earth and Environmental Science. Accessed online, September 11, 2018, <http://iopscience.iop.org/article/10.1088/1755-1315/22/1/012020/pdf>; “The Mount Whitney Water Power Electric Plant and Light Regulating Device,” *Engineering News*, Vol. XLII, No. 10, September 7, 1899, 151.

¹³ “System of the Mount Whitney Power and Electric Company,” *Journal of Electricity, Power, and Gas*, Vol. XXXI, No. 26, December 27, 1913.

*Resource Name or # (Assigned by recorder)

D1. Historic Name: Kaweah Hydroelectric Project D2. Common Name: Kaweah Hydroelectric Project, FERC Project No. 298: Kaweah No. 3 Hydroelectric System Historic District

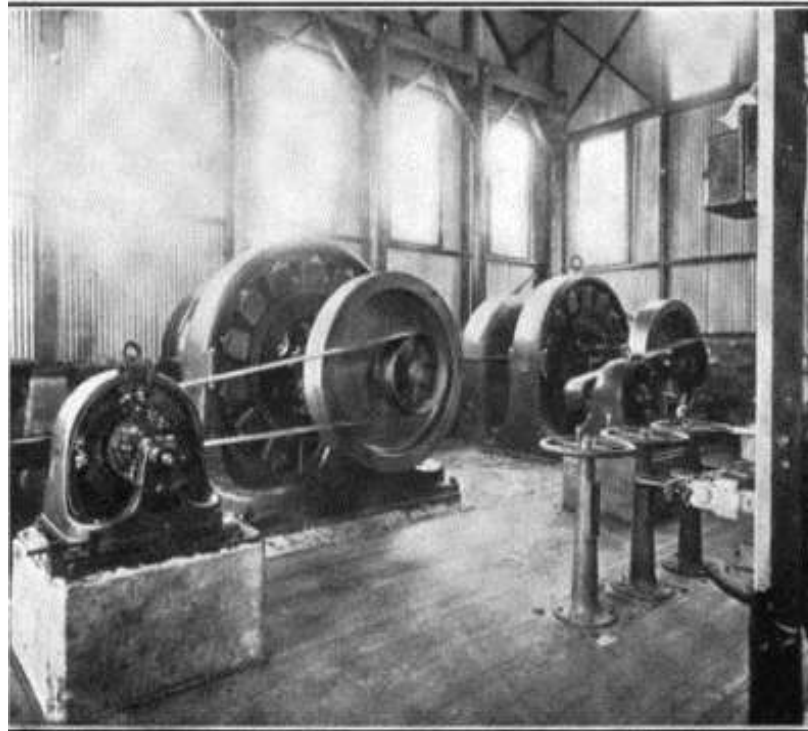

Figure 4: Interior of Powerhouse No. 1, circa 1900
(*Association of Engineering Societies, Vol. XXXIV, No. 3, March 1905, 86.*)

As designed, the powerhouse had a capacity of 2,000 horsepower (hp) and was noted for its, “compact and logical arrangement,” containing three Doble Tangential water wheels, three Westinghouse Kodak type three-phase AC generators, and four Westinghouse oil insulated air cooled transformers which stepped up power from 440 volts to 17,300 volts for transmission (**Figure 4**). The transmission system included 42 miles of redwood pole line to Porterville, and 41 miles to Tulare—with substations in Visalia, Tulare, Exeter, Lindsay, and Porterville. The powerhouse’s penstock was fabricated and laid by the Lacy Manufacturing Company of Los Angeles and descended approximately 1,300 feet from the terminus of the flume on the steep canyon above the powerhouse. The penstock was constructed with riveted steel and trenched for the bulk of the alignment, with a starting diameter of 50 inches, tapering to approximately 20 inches at the powerhouse.¹⁴

Water for the powerhouse was diverted from the East Fork of the Kaweah River, with a small masonry diversion dam constructed approximately 5 miles above the confluence of the East and Middle Forks of the Kaweah River. The simple dam conveyed water into a 47-foot-long drilled rock tunnel and subsequently to the redwood flume below (**Figure 5**). As described by Project engineers, “The diversion dam was located at

¹⁴ “Hydroelectric Power Development and Transmission in California,” *Association of Engineering Societies*, Vol. XXXIV, No. 3, March 1905, 80-90; “The Mount Whitney Water Power Electric Plant and Light Regulating Device,” *Engineering News*, Vol. XLII, No. 10, September 7, 1899, 151; “System of the Mount Whitney Power and Electric Company,” *Journal of Electricity, Power, and Gas*, Vol. XXXI, No. 26, December 27, 1913.

*Resource Name or # (Assigned by recorder)

D1. Historic Name: Kaweah Hydroelectric Project D2. Common Name: Kaweah Hydroelectric Project, FERC Project No. 298: Kaweah No. 3 Hydroelectric System Historic District

the outlet of a natural basin where a small granite masonry dam maintains the water level for the intake to the conduit. The tunnel runs through a jutting rock spur, delivering the water from this basin to a timber flume, which follows the very precipitous mountain side of the south slope of the canyon.”¹⁵



Figure 5: Overview of Kaweah No. 1 Diversion Dam with Catwalk leading to Flume (l-r), 1908
(Huntington Digital Library, SCE Photograph Collection, Call Number 04 - 00720)

The Kaweah No. 1 flume was constructed of redwood and followed the south bank of the river canyon, running for 30,723 feet, or 6 miles, to its terminus above the powerhouse. The flume, “followed the common practices in California at the time it was built,” and was 3 feet wide in section and 2 feet deep. The flume body was supported by redwood posts, which varied in height depending on ground contour, ranging from heights of 6 feet to 50. The capacity of the flume was 17 cubic feet per second (**Figures 6 and 7**).

¹⁵ “System of the Mount Whitney Power and Electric Company,” *Journal of Electricity, Power, and Gas*, Vol. XXXI, No. 26, December 27, 1913.

Page 15 of 199

*NRHP Status Code:

*Resource Name or # (Assigned by recorder)

D1. Historic Name: Kaweah Hydroelectric Project D2. Common Name: Kaweah Hydroelectric Project, FERC Project No. 298: Kaweah No. 3 Hydroelectric System Historic District

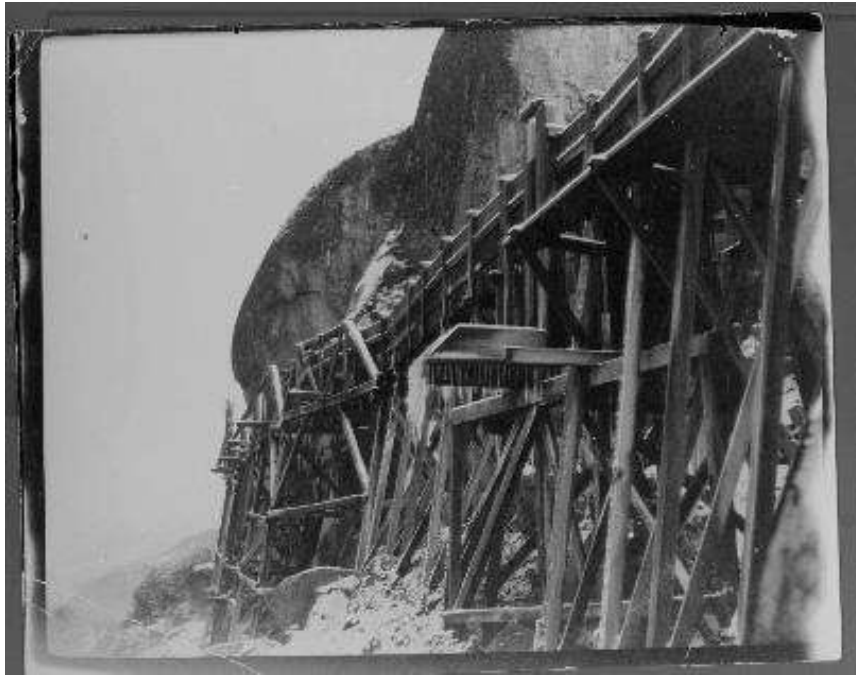

Figure 6: Representative Trestle Section of Kaweah No. 1 Flume, circa 1908
(Huntington Digital Library, SCE Photograph Collection, Call Number 04 - 00721)



Figure 7: Kaweah No. 1 Flume at Powerhouse No. 1 Penstock, circa 1908
(Huntington Digital Library, SCE Photograph Collection, Call Number 04 - 00724)

*Resource Name or # (Assigned by recorder)

D1. Historic Name: Kaweah Hydroelectric Project D2. Common Name: Kaweah Hydroelectric Project, FERC Project No. 298: Kaweah No. 3 Hydroelectric System Historic District

Upon completion of the initial Kaweah development, Maddox's Visalia Times proclaimed, "The long-distance electric plant which begins today to furnish power will make the wheels of manufacturing establishments turn, irrigating plants multiply, and darkness light." Despite this proclamation, securing the Tulare County load for the system was a somewhat protracted endeavor, with initial consumption limited. Although the intended consumers were primarily farmers, many were reticent to purchase the required pumps and equipment. As such, during the first years of operation, growth was somewhat slow, with approximately 700 hp of the available 2,000 utilized. Additionally, the earliest contracts were generally non-agricultural in nature, with service extending to commercial concerns including the county's ice plants, hotels, newspapers, and other commercial entities. Recognizing the need for incentives and demonstrating a strong acuity for marketing, Albert Wishon ultimately secured funds to purchase pumps himself, offering them to farmers on credit. With this substantial buy-in hurdle cleared, adoption rates climbed. By 1903 Mount Whitney Power Company had 710 subscribers, primarily agricultural—a number which soared to thousands in the span of a decade.¹⁶

Even as Mount Whitney Power Company continued to expand as a major force for development of Tulare County, quarrels over the company's scope of development ultimately led to the defection of founding partner Albert Wishon. While Wishon had a grand view of development which encompassed virtually all of the major watersheds of central California, Hammond and Maddox were more regional in focus, with a smaller lens that only included more modest developments in Tulare County. In 1902, Wishon left the company, forming San Joaquin Light and Power Company in Fresno with a cadre of business partners. At San Joaquin Light and Power Company, Wishon continued his emphasis on agricultural irrigation, creating a formidable rival in the Central California region.¹⁷

Kaweah No. 2 Development

As consumer adoption climbed, Mount Whitney Power Company turned to expansion of the system, with planning and construction of a second powerhouse initiated in the first years of the twentieth century. By 1904, Powerhouse No. 2 was under construction, located across the Kaweah River from Powerhouse No. 1, approximately 1 mile downstream. In contrast to most California hydroelectric plants constructed at the time and to the present, the powerhouse was considered a "low-head" installation, fed by a small penstock with static head of only 351 feet. Associated system components included a diversion dam on the Kaweah River, approximately 1 mile above its confluence with the East Fork; an approximately 4 mile-long canal extending to the powerhouse, of which most was concrete-lined ditch with some components timber flume; a small regulating forebay; and the 1,000-foot penstock leading to the powerhouse.¹⁸

The company used a utilitarian design similar to the Kaweah No. 1 Powerhouse, with a rectangular-plan building of wood-frame construction and corrugated iron sheathing (**Figure 8**). The building measured approximately 30 feet by 50 feet and was initially developed with three General Electric generating units and Victor Girard Type Turbine, each with a capacity of 500 kilowatts (kW) (**Figure 9**). Within several years, two

¹⁶ *Visalia Times*, "Kaweah Hydroelectric Development," June 29, 1899; "System of the Mount Whitney Power and Electric Company," *Journal of Electricity, Power, and Gas*, Vol. XXXI, No. 26, December 27, 1913.

¹⁷ Earl A. McKee, Jr., Gaynor B. McKee, and Carol Nadine McGrew, *Echoes of Three Rivers: Landmarks and Lore*, 71-83; James C. Williams, *Energy and the Making of Modern California*, 180-224; William A. Meyers, *Iron Men and Copper Wires, A Centennial History of the Southern California Edison Company* (Glendale, CA: Trans-Anglo Books, 1947, 86-91.

¹⁸ "System of the Mount Whitney Power and Electric Company," *Journal of Electricity, Power, and Gas*, Vol. XXXI, No. 26, December 27, 1913.

*Resource Name or # (Assigned by recorder)

D1. Historic Name: Kaweah Hydroelectric Project D2. Common Name: Kaweah Hydroelectric Project, FERC Project No. 298: Kaweah No. 3 Hydroelectric System Historic District

of these units were removed and replaced with a single 1,500 kW General Electric Generator attached to a Francis-type turbine. Seven transformers were housed in a concrete extension attached to the powerhouse, with a transmission voltage of 35,000 volts.¹⁹



Figure 8: Kaweah No. 2 Powerhouse, 1904
(Huntington Digital Library, SCE Photograph Collection, Call Number 04 - 00069)

The Kaweah No. 2 Diversion paralleled that of Kaweah No. 1 Diversion in design, in that the dam was of a low-form granite masonry construction that utilized the natural curvature of the river's flanking ledges (**Figure 10**). The maximum height of the dam was 8 feet. Four hand operated sluice gates controlled flow into the canal. Slightly over 3 miles of the canal was concrete-lined ditch, with 0.75 mile of timber flume where conditions precluded ditching (**Figure 11**). The Kaweah No. 2 Forebay was modest in scale, with a length of 270 feet, a width of 12 feet, and a depth of 9 feet (**Figure 12**). From the forebay, the penstock extended 1,000 feet to the turbines of Powerhouse No. 2 below.

¹⁹ "System of the Mount Whitney Power and Electric Company," *Journal of Electricity, Power, and Gas*, Vol. XXXI, No. 26, December 27, 1913.

Page 18 of 199

*NRHP Status Code:

*Resource Name or # (Assigned by recorder)

D1. Historic Name: Kaweah Hydroelectric Project D2. Common Name: Kaweah Hydroelectric Project, FERC Project No. 298: Kaweah No. 3 Hydroelectric System Historic District

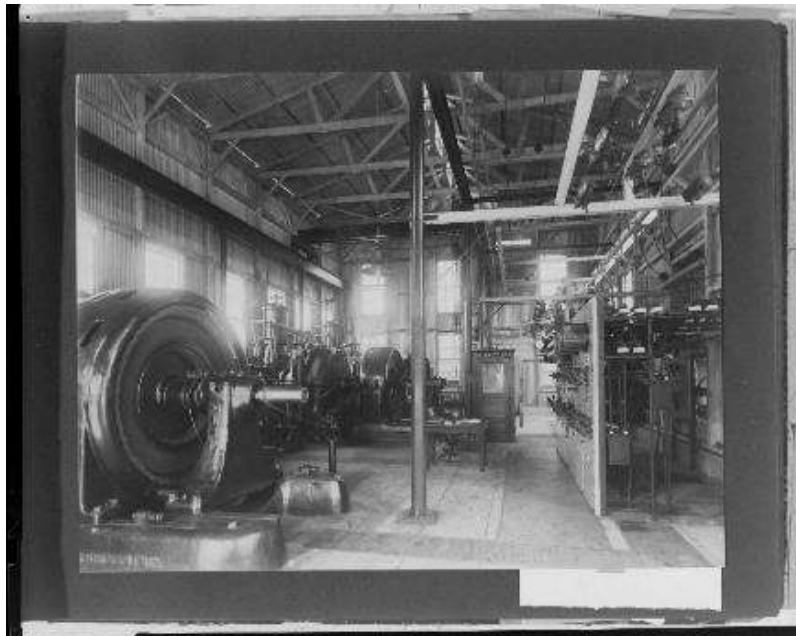

Figure 9: Kaweah No. 2 Powerhouse Interior, circa 1908
(Huntington Digital Library, SCE Photograph Collection, Call Number 04 - 00735)

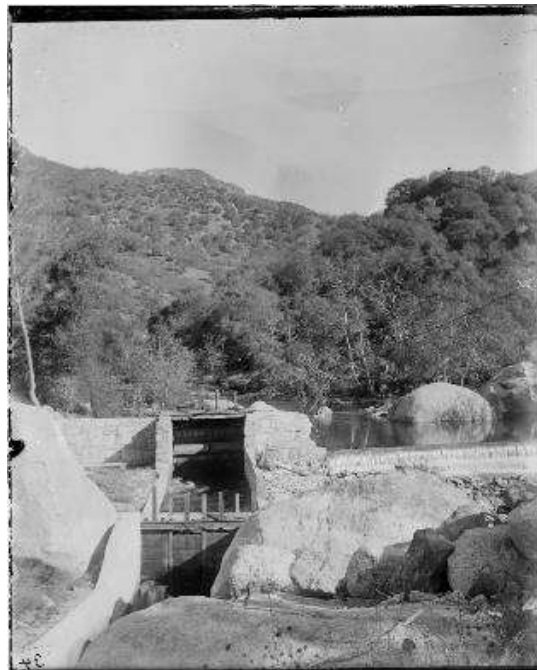

Figure 10: Kaweah No. 2 Diversion, 1908
(Huntington Digital Library, SCE Photograph Collection, Call Number 04 - 00034)

Page 19 of 199

*NRHP Status Code:

*Resource Name or # (Assigned by recorder)

D1. Historic Name: Kaweah Hydroelectric Project D2. Common Name: Kaweah Hydroelectric Project, FERC Project No. 298: Kaweah No. 3 Hydroelectric System Historic District

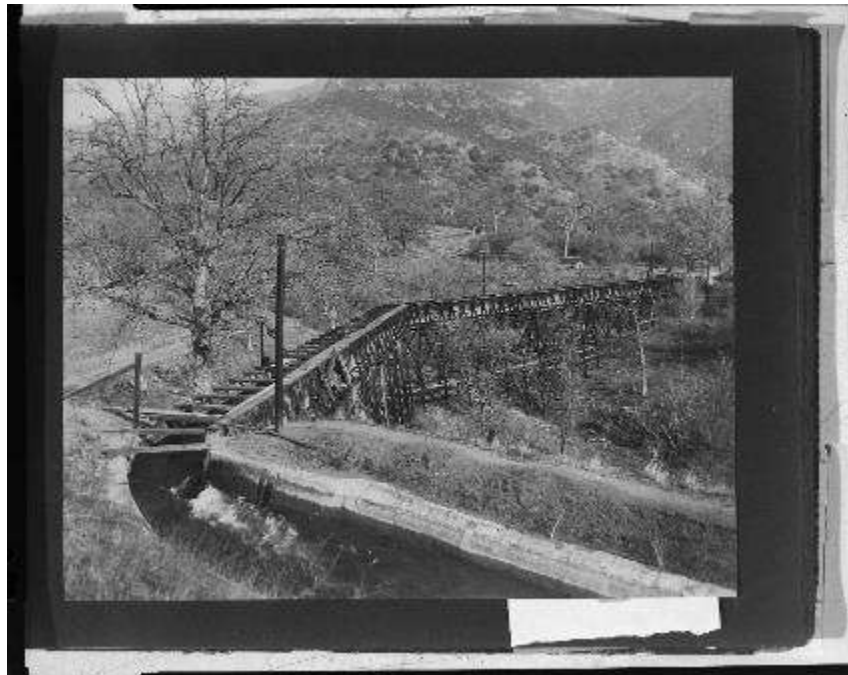

Figure 11: Kaweah No. 2 Concrete Ditch and Flume Section, circa 1908
(Huntington Digital Library, SCE Photograph Collection, Call Number 04 - 00732)

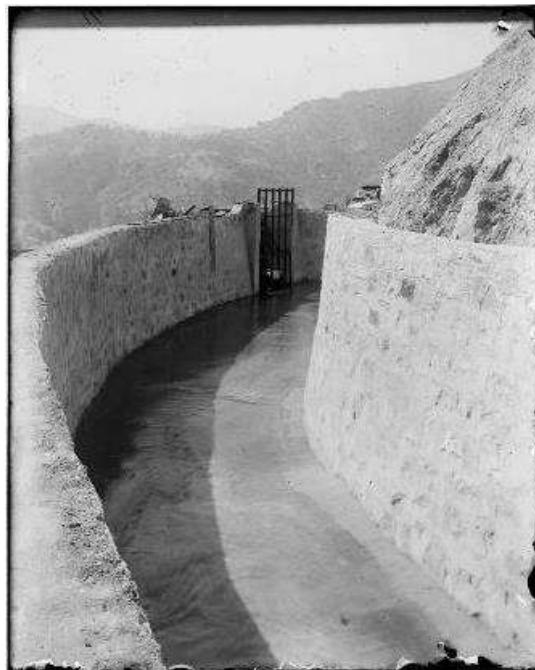

Figure 12: Kaweah No. 2 Forebay, 1908
(Huntington Digital Library, SCE Photograph Collection, Call Number 04 - 00071)

*Resource Name or # (Assigned by recorder)

D1. Historic Name: Kaweah Hydroelectric Project D2. Common Name: Kaweah Hydroelectric Project, FERC Project No. 298: Kaweah No. 3 Hydroelectric System Historic District

As Mount Whitney Power Company added capacity with the development of Powerhouse No. 2, they also sought to stabilize flow for the Kaweah No. 1 development. The company's studies indicated that the geologic and geographic setting of the Kaweah System precluded the siting of large reservoirs, with the system largely dependent on run-of-the-river flows. While flows were deemed adequate much of the year, the late season cessation of flows coincided with the time of heightened demand for agricultural irrigation, thus stressing the system supply. To supplement flows, Mount Whitney Power Company incorporated several natural high Sierra lakes into the system. Termed the Mineral King Lakes, the small reservoirs included Lady Franklin Lake, Silver (Crystal) Lake, Eagle Lake, and Monarch Lake. The small lakes were dammed with low masonry dams between 1903 and 1905 and served to modestly augment flows along the East Fork of the Kaweah River and in turn Kaweah Powerhouse No. 1, adding 1,153 acre feet of storage to the system (**Figure 13**). Note that the Mineral King Lakes are located within the boundaries of the SNP and are therefore not included in the current FERC Kaweah Project license.



Figure 13: Monarch Lake Masonry Dam Section, 1951
(Huntington Digital Library, SCE Photograph Collection, Call Number 02-30795)

Kaweah No. 3 Development

As more farmers adopted pump irrigation, expanded cultivated acreage, and diversified their holdings, even the additional generation provided by the Kaweah No. 2 development quickly proved inadequate to meet

*Resource Name or # (Assigned by recorder)

D1. Historic Name: Kaweah Hydroelectric Project D2. Common Name: Kaweah Hydroelectric Project, FERC Project No. 298: Kaweah No. 3 Hydroelectric System Historic District

demand. A company graphic from the period demonstrates the steady growth curve, with yearly demand threatening to outstrip generation output (Figure 14). By 1906, Mount Whitney Power Company had applied for permits to construct a third power plant, Kaweah No. 3, which would divert water from the Marble and Middle Forks of the Kaweah River. System components included the powerhouse, two diversion dams, and a Y-shaped flowline and siphon that traversed approximately 7 miles of rugged terrain. Permitting was complicated by the fact that portions of the proposed project were located within the boundary of the newly established SNP, including both diversions and much of the flowline. Thus, Mount Whitney Power Company applied for permits from both the Secretary of the Interior and Secretary of Agriculture, accounting for the flanking jurisdictions of the SNP and Sierra National Forest (SNF). The company received a permit from the Secretary of the Interior in 1907, with a temporary permit from the Secretary of Agriculture in 1909; this permit was superseded by a permit issued by the Federal Power Commission in 1924, the antecedent of the current FERC.²⁰

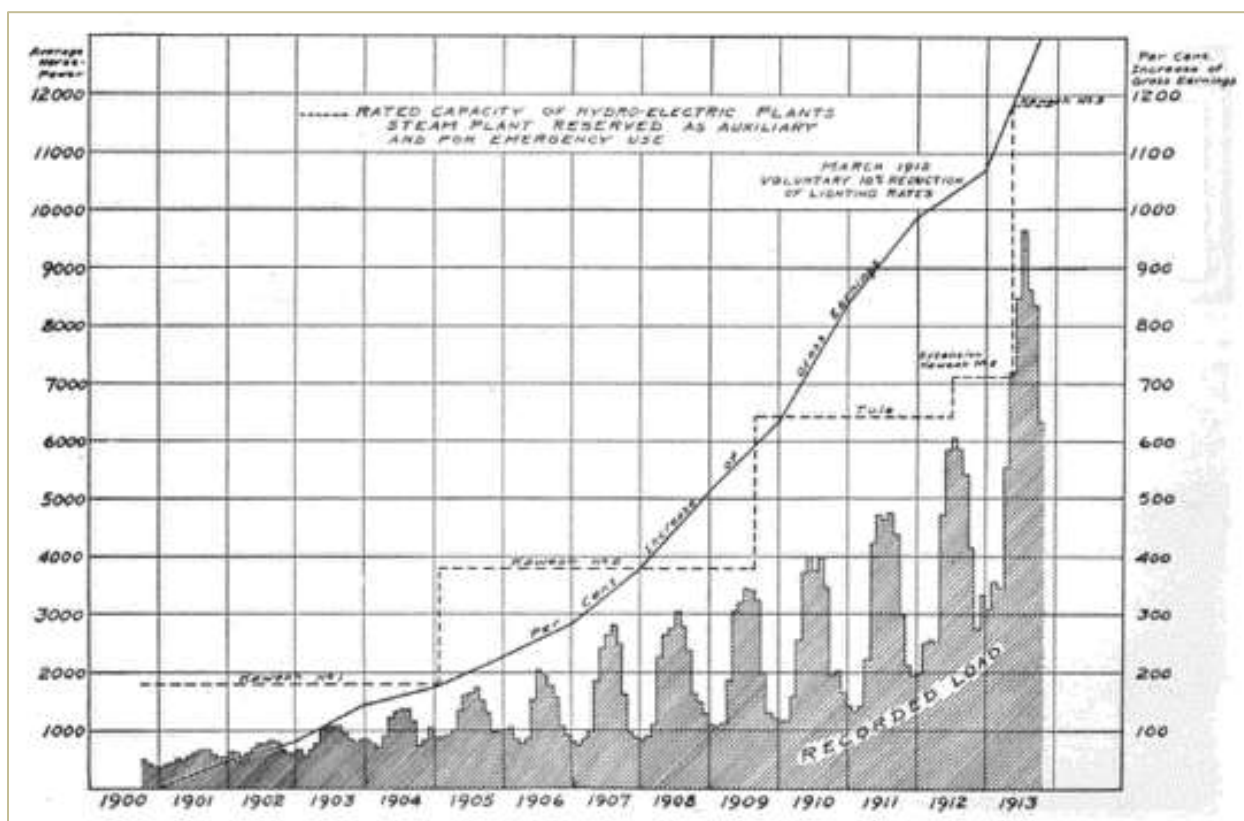

Figure 14: Mount Whitney Power Company Demand Graph, 1913
 (*Journal of Electricity, Power, and Gas*, Vol. XXXI, No. 26, December 27, 1913)

²⁰ Earl A. McKee, Jr., Gaynor B. McKee, and Carol Nadine McGrew, *Echoes of Three Rivers: Landmarks and Lore*, 71-83; James C. Williams, *Energy and the Making of Modern California*, 180-224; William A. Meyers, *Iron Men and Copper Wires, A Centennial History of the Southern California Edison Company* (Glendale, CA: Trans-Anglo Books, 1947, 86-91.

*Resource Name or # (Assigned by recorder)

D1. Historic Name: Kaweah Hydroelectric Project D2. Common Name: Kaweah Hydroelectric Project, FERC Project No. 298: Kaweah No. 3 Hydroelectric System Historic District

In contrast to the utilitarian corrugated metal design of the system's first two powerhouses, Kaweah Powerhouse No. 3 was of a far more substantial reinforced concrete design, measuring 50 feet by 50 feet and reflective of a heightened yet spare classical design sensibility (**Figure 15**). The design was reflective of both the company's stature as a major regional utility and the overall tone of monumental design that came to characterize powerhouse construction in the 1910s and 1920s. In contrast to the earliest plants, which were often designed with little attention to architectural allusion, the plants of the early twentieth century took on an increasingly monumental tone, as utility companies sought to convey the stature of the industry through architectural form.



Figure 15: Kaweah No. 3 Powerhouse, 1920
(Huntington Digital Library, SCE Photograph Collection, Call Number 02 - 06179)

The powerhouse was situated directly above the diversion intake for the Kaweah No. 2 Powerhouse, so that outflow from Powerhouse No. 3 fed directly to the diversion. The interior of the powerhouse was characterized by a main generating room floor with two Westinghouse generators, with a transverse interior partition separating the generating facilities from the four transformers and high tension bus. The three-phase generators were rated at 2,300 volts. The two single-jet single-overhung turbines were of the Pelton-Doble design and were supplied by the Pelton Water Wheel Company (**Figure 16**). Power from the plant was

*Resource Name or # (Assigned by recorder)

D1. Historic Name: Kaweah Hydroelectric Project D2. Common Name: Kaweah Hydroelectric Project, FERC Project No. 298: Kaweah No. 3 Hydroelectric System Historic District

transmitted at 35,000 volts, connecting to the main transmission line extending from Powerhouse No. 1 via a 2.5-mile-long wood pole line.²¹

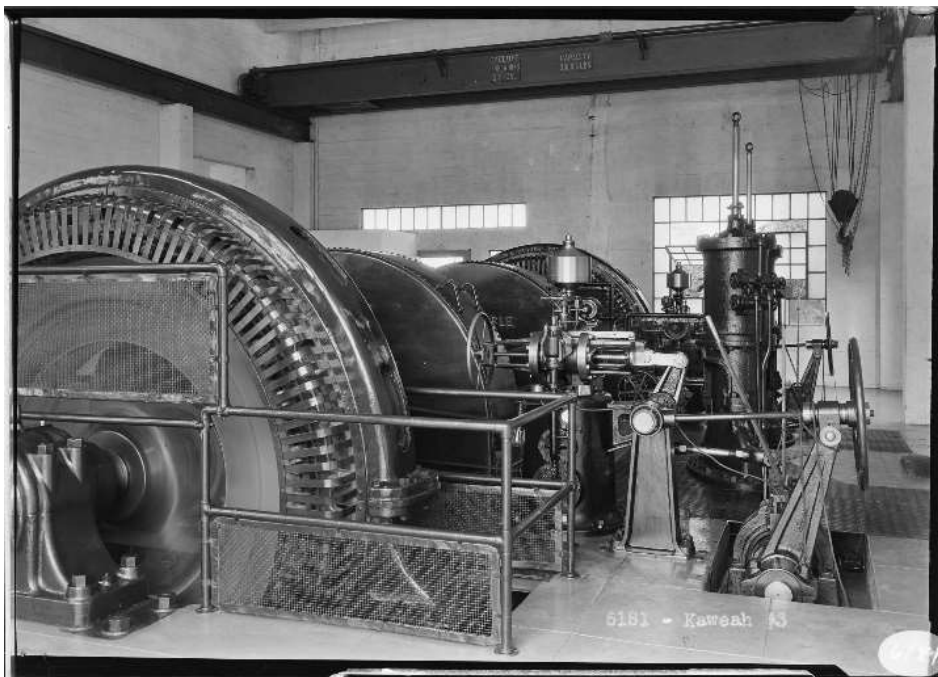

Figure 16: Kaweah No. 3 Powerhouse Interior, 1920
(Huntington Digital Library, SCE Photograph Collection, Call Number 02 - 06181)

The Powerhouse No. 3 Penstock descended 3,000 feet from the termination of the Kaweah No. 3 Flowline, with a static head of 776 feet. The penstock was constructed with riveted steel with a 42-inch diameter that tapered to 36 inches. The pipe was trenched for the majority of the alignment, with reinforced concrete anchor blocks at vertical angles to secure the pipe to the bedrock below. A tramway was developed along the alignment to support construction of the pipeline and the forebay above, which has since been removed from the site.

The Middle and Marble Fork diversion dams were relatively diminutive in size and scale, mirroring earlier system construction. The Middle Fork was of concrete construction with an Ogee spillway section. The intake was on the south bank, forming a canal wall leading to sluice gates that manually operated to control flow into the canal (**Figure 17**). The Marble Fork Diversion Dam was of a similar design, with a concrete box canal diverting water to sluice gates and thence to the Marble Fork Flowline and Siphon (**Figure 18**).

²¹ "System of the Mount Whitney Power and Electric Company," *Journal of Electricity, Power, and Gas*, Vol. XXXI, No. 26, December 27, 1913.

*Resource Name or # (Assigned by recorder)

D1. Historic Name: Kaweah Hydroelectric Project D2. Common Name: Kaweah Hydroelectric Project, FERC Project No. 298: Kaweah No. 3 Hydroelectric System Historic District

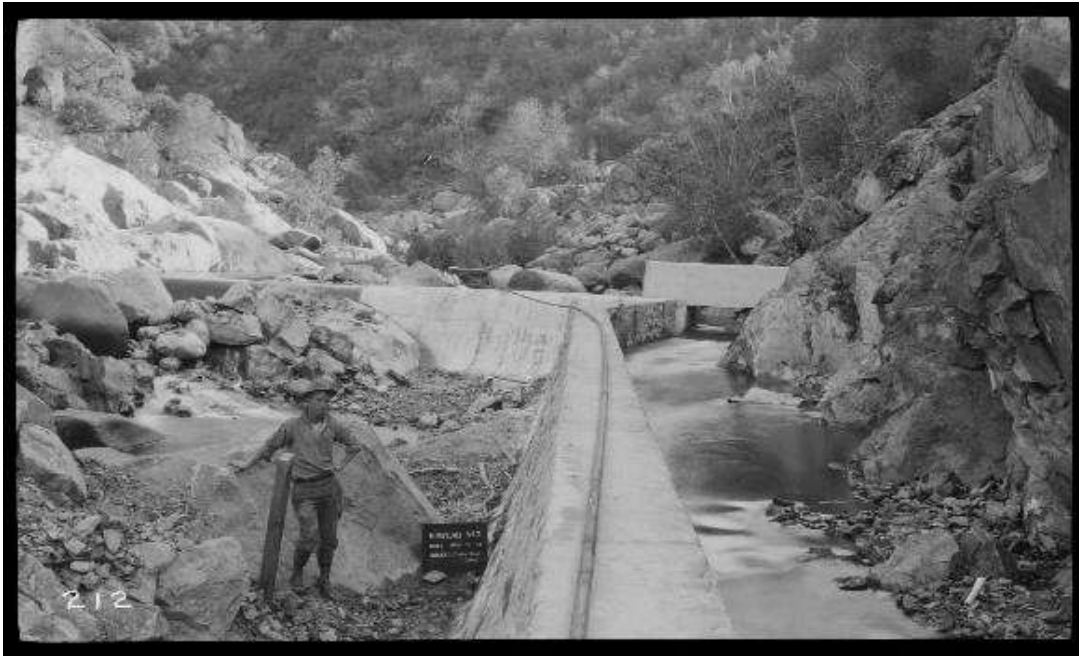

Figure 17: Middle Fork Diversion Dam, circa 1912
(Huntington Digital Library, SCE Photograph Collection, Call Number 04 - 00212)

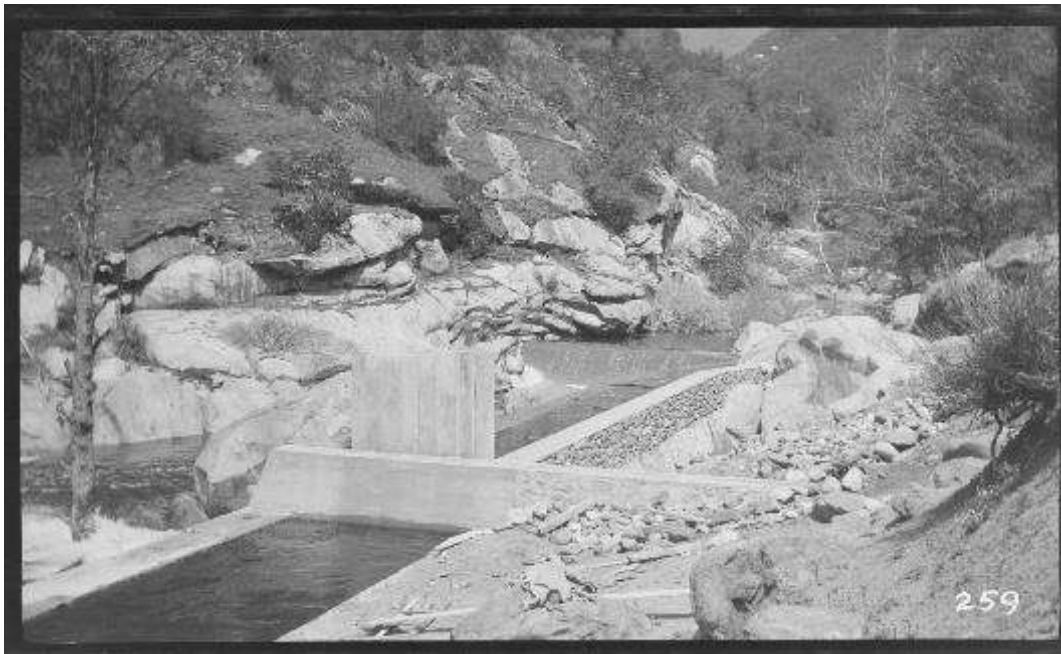

Figure 18: Marble Fork Diversion Dam, circa 1913
(Huntington Digital Library, SCE Photograph Collection, Call Number 04 - 00259)

*Resource Name or # (Assigned by recorder)

D1. Historic Name: Kaweah Hydroelectric Project D2. Common Name: Kaweah Hydroelectric Project, FERC Project No. 298: Kaweah No. 3 Hydroelectric System Historic District

The Y-shaped integrated flowline connecting the Middle and Marble Fork diversions with Powerhouse No. 3 garnered engineering praise upon construction, with period engineering commentators noting the efficiency of the line's inverted siphon and the advanced design of the 4-mile concrete canal:

This conduit line has a number of points of interest to engineers as it is quite unique in its design and method of construction and represents the latest engineering effort along this line. From the Marble Fork Diversion the canal is carried along the north bank of the Marble to above the junction of the two branches of the river...this terminus acts as a head box for a steel inverted siphon, which carries the flow of this canal across the Middle Fork, rising to a junction with the canal from the Middle Fork Diversion. The waters of the two branches are thus mingled and then carried in a combined canal which follows the east slope of the Middle Fork to its terminus at a forebay reservoir for Powerhouse No. 3. The ground surface followed by this conduit line is very rough and uneven, requiring a major construction effort.²²

Depending on the terrain, the flowline sections were constructed using concrete-lined ditch or put-in-place concrete slabs, with either single slabs or double slabs set on low concrete rubble piers (**Figures 19** and **20**). All concrete was made on site, with a crushing plant located at the confluence of the two forks of the river and a small rail track ascending to the flowline grade for transport. The inverted siphon, which carried water from the Marble Fork across the Middle Fork Kaweah River Canyon, was buried, even as it crossed the Middle Fork Kaweah River stream bed (**Figure 21**). The buried siphon at the stream bed was anchored in solid concrete and buried so as to avoid damage from any flooding events. Interestingly, a second section of siphon pipe was laid next to the first under the Middle Fork Kaweah River stream bed, as at the time of construction Mount Whitney Power Company contemplated adding a second inverted siphon to the system, which ultimately never came to fruition. Because of the arduous construction techniques and the time consuming placement of the jointed concrete slab forms, construction of the siphon was estimated at approximately \$40,000 per mile.²³

When the Kaweah No. 3 Powerhouse came on-line in May of 1913, the Kaweah No. 3 Flowline flowed directly to a steel pressure pipe leading to the powerhouse penstock, with the planned regulating forebay not yet complete. Under this interim design, the flowline terminated at a steel pipe that ran horizontally 839 feet across the hillside, leading to a stand pipe that regulated the steep descent of the vertical penstock. Upon completion of the Kaweah No. 3 Forebay, the largest of the Kaweah System with an 11 acre-foot capacity, a large section of the horizontal pipeline was abandoned, and flows were regulated from the forebay reservoir (**Figure 22**). At present, an abandoned section of steel pipe is evident on the hillside below the Kaweah No. 3 Forebay.

With completion of the Kaweah No. 3 Powerhouse, the Mount Whitney Power Company cemented its regional role as the preeminent utility in Tulare County, with an invested capital of over 5 million dollars, a connected load of over 14,000 kW, and 179 miles of transmission lines that coursed through the region's towns and agricultural fields. In addition to the three hydroelectric plants the company held at Kaweah, the Mount Whitney Power Company had purchased the Globe Light and Power Company's Tule River Hydroelectric Plant in 1909 to bolster supplies, with additional steam-powered plants in Visalia and Tulare adding to the

²² "System of the Mount Whitney Power and Electric Company," *Journal of Electricity, Power, and Gas*, Vol. XXXI, No. 26, December 27, 1913.

²³ "System of the Mount Whitney Power and Electric Company," *Journal of Electricity, Power, and Gas*, Vol. XXXI, No. 26, December 27, 1913.

*Resource Name or # (Assigned by recorder)

D1. Historic Name: Kaweah Hydroelectric Project D2. Common Name: Kaweah Hydroelectric Project, FERC Project No. 298: Kaweah No. 3 Hydroelectric System Historic District

company's portfolio. Mount Whitney Power Company's central role in the physical and economic development of the region was a vaunted point of fact for California's agricultural press, with Pacific Rural Press noting in 1914 "No other factor has had a greater influence on [agricultural] development in Tulare County in recent years than the pumping plant, our larger sections today are almost wholly indebted to this new form of water supply for their recent progress." Thus, less than twenty years after initial surveys and planning, the hydroelectric supplies developed by Mount Whitney Power Company had become an inextricable component of the region's physical and economic landscape, with electricity generated by the company creating a patchwork of new development across the San Joaquin Valley, development which in and of itself spurred the need for more electrical supplies. As observed by a period commentator, electrical engineer Putnam Bates, "It is hard to tell whether the power companies made the irrigated farms or farms guaranteed the success of the power companies, the interests seem to have worked together."²⁴



Figure 19: Marble Fork Flowline, circa 1912
(Huntington Digital Library, SCE Photograph Collection, Call Number 04 - 00276)

²⁴ James C. Williams, *Energy and the Making of Modern California*, 225; Water Development in Tulare County," *Pacific Rural Press*, March 21, 1914, 365.

Page 27 of 199

*NRHP Status Code:

*Resource Name or # (Assigned by recorder)

D1. Historic Name: Kaweah Hydroelectric Project D2. Common Name: Kaweah Hydroelectric Project, FERC Project No. 298: Kaweah No. 3 Hydroelectric System Historic District



Figure 20: Marble Fork Siphon, circa 1912
(Huntington Digital Library, SCE Photograph Collection, Call Number 04 - 00137)

Page 28 of 199

*NRHP Status Code:

*Resource Name or # (Assigned by recorder)

D1. Historic Name: Kaweah Hydroelectric Project D2. Common Name: Kaweah Hydroelectric Project, FERC Project No. 298: Kaweah No. 3 Hydroelectric System Historic District

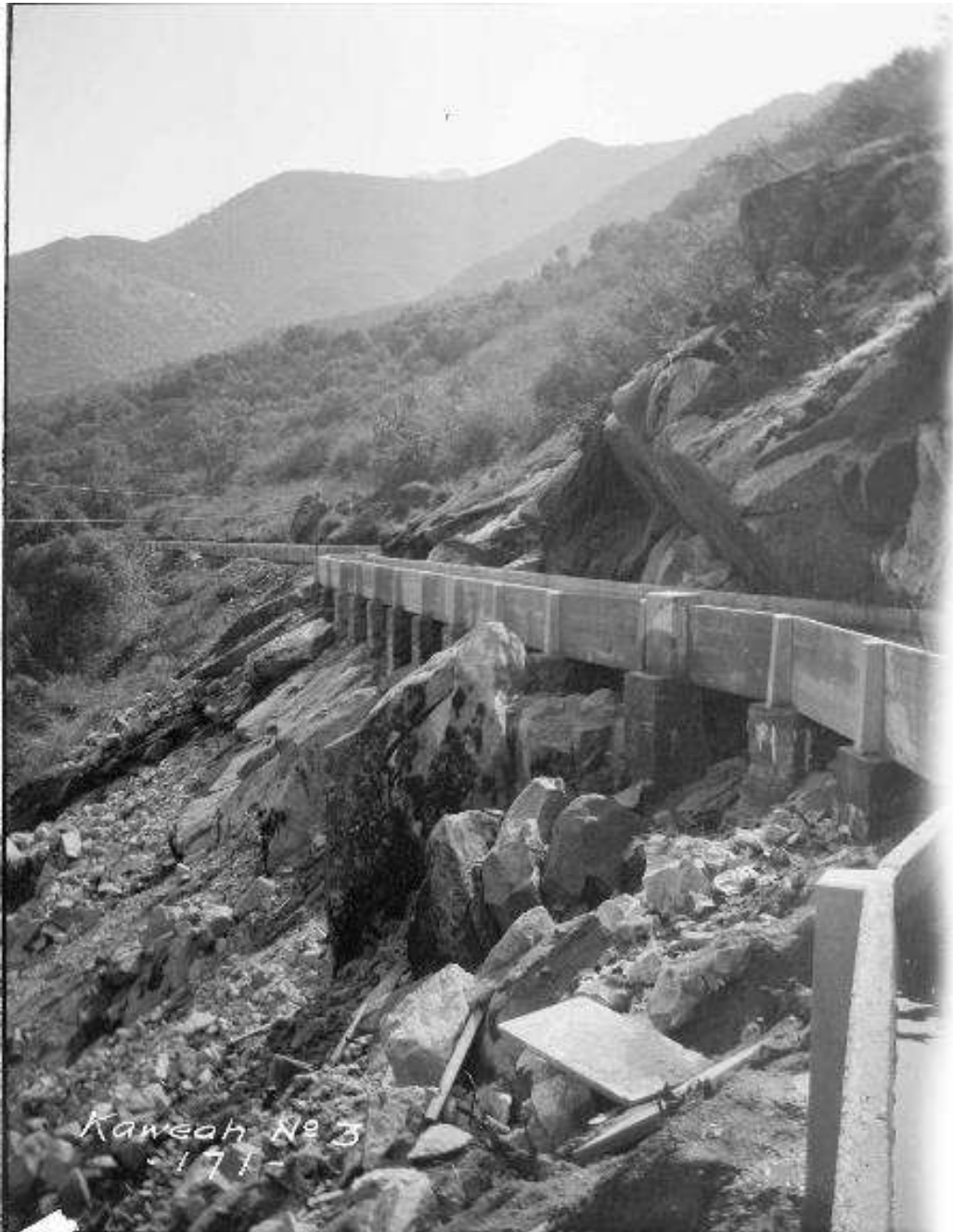

Figure 21: Middle Fork Flowline, circa 1912
(Huntington Digital Library, SCE Photograph Collection, Call Number 04 - 00171)

*Resource Name or # (Assigned by recorder)

D1. Historic Name: Kaweah Hydroelectric Project D2. Common Name: Kaweah Hydroelectric Project, FERC Project No. 298: Kaweah No. 3 Hydroelectric System Historic District



Figure 22: Kaweah No. 3 Forebay, 1947
(Huntington Digital Library, SCE Photograph Collection, Call Number 02-27826)

Industry Consolidation and Absorption by SCE

Despite Mount Whitney Power Company's strong regional market position, the company was subject to a number of serious development pressures by the mid-1910s, both specific to the company itself and related to trends of industry-wide consolidation that characterized the period. First, while the company dominated the Tulare County market, further physical growth was largely hampered by the rival developments of former partner Albert G. Wishon, whose San Joaquin Light and Power Company had developed extensively in the regions surrounding Mount Whitney Power Company's territory, and who at times seemed personally motivated to curtail Mount Whitney's success. In essence, as San Joaquin Light and Power developed facilities in the towns and watersheds surrounding Mount Whitney Power Company's facilities, the Mount Whitney Power Company became increasingly landlocked in their growth potential—with both supplies and market expansion increasingly constrained. As such, by 1916, the Mount Whitney Power Company was facing something of a crisis of supply, with even their auxiliary steam plants barely providing sufficient backup, little room for new development, and a hostile rival edging closer. In addition to this imminent crisis, by this period the larger energy context in California was in a state of upheaval. Although the period was a time of great expansion for the electrical industry as a whole, the period was also one of escalating industry consolidation, driven by both geographic considerations and increased financial pressures. While the industry was largely

*Resource Name or # (Assigned by recorder)

D1. Historic Name: Kaweah Hydroelectric Project D2. Common Name: Kaweah Hydroelectric Project, FERC Project No. 298: Kaweah No. 3 Hydroelectric System Historic District

born of small, geographically-focused entities like Mount Whitney Power Company, by the 1910s improvements in transmission technology and capital consolidation had winnowed the field substantially—ushering in the development of a small cadre of large utilities that differed markedly from the isolated companies that had characterized the first wave of hydroelectric development. Against this backdrop, the first wave of small utilities was steadily absorbed by a small number of larger companies.²⁵

In response to these pressures, an aging John Hays Hammond, brother of William Henry Hammond and majority stockholder in the Mount Whitney Power Company, relinquished control of the Mount Whitney Power Company in 1916, selling all of his shares to Los Angeles industrial magnate Henry E. Huntington. For Huntington, the purchase served as a key chess-piece for his own hydroelectric developments, operated as Pacific Light and Power Company (PLPC). In 1913, Huntington's PLPC had completed initial developments on the San Joaquin River at Big Creek, one of California's largest and most innovative hydroelectric projects of the period. The 150 Kilovolt (kV) transmission lines of the Big Creek Hydroelectric System ran directly through the Mount Whitney Power Company's service territory as they extended to their primary market of Los Angeles. Thus, Huntington simultaneously purchased new regional supplies, and perhaps more importantly, purchased a booming Tulare County consumer market to offload the Big Creek Hydroelectric System's abundant electrical supplies.²⁶

In a testament to the rapidity of the consolidation of the period, by 1917 the former holdings of the Mount Whitney Power Company had changed hands yet again, with PLPC in turn purchased in whole by one of the state's growing electrical behemoths—SCE. The sale was completed in 1917, with the holdings of PLPC continuing to independently operate as subsidiaries of SCE until 1920. In that year, the holdings were officially absorbed, with the masthead of SCE garnering the former facilities of Mount Whitney Power Company. SCE has continued to operate the Kaweah River system in the nearly one hundred years since acquisition, with the 8.85 MW Kaweah River Hydroelectric plants serving as a small component of the utility's current 1,176 MW hydroelectric network.²⁷

Kaweah Project Operations under SCE Ownership

While the Kaweah Project has continued to operate largely as designed under SCE ownership, many system components have undergone substantial material changes over the past century. These changes primarily correspond to technological innovations in hydroelectric engineering and operations as well as ongoing material alterations to address functional life spans of system components—a necessary and vital component of hydroelectric operations.

²⁵ William A. Meyers, *Iron Men and Copper Wires, A Centennial History of the Southern California Edison Company* (Glendale, CA: Trans-Anglo Books, 1947, 86-91; James C. Williams, *Energy and the Making of Modern California*, 225.

²⁶ William A. Meyers, *Iron Men and Copper Wires, A Centennial History of the Southern California Edison Company* (Glendale, CA: Trans-Anglo Books, 1947, 86-91

²⁷ William A. Meyers, *Iron Men and Copper Wires, A Centennial History of the Southern California Edison Company* (Glendale, CA: Trans-Anglo Books, 1947, 86-91; "Historic-Era Electrical Infrastructure Management Program," drafted by Southern California Edison Company, August 2015.

*Resource Name or # (Assigned by recorder)

D1. Historic Name: Kaweah Hydroelectric Project D2. Common Name: Kaweah Hydroelectric Project, FERC Project No. 298: Kaweah No. 3 Hydroelectric System Historic District

The most significant change to the Kaweah Project was the 1929 demolition and removal of the Mount Whitney Power Company's original 1899 Kaweah No. 1 Powerhouse. The corrugated metal powerhouse was considered functionally obsolete and replaced with a modest reinforced concrete structure located several hundred feet upstream, with a spare classical tone that mirrors both that of Kaweah Powerhouse No. 3 and general powerhouse design of the period (**Figure 23**). The powerhouse was equipped with a single, single-jet, single-overhung Allis-Chalmers impulse turbine, with a rated capacity of 2.2 MW, which remains in operation today. In order to incorporate the new powerhouse, the original Kaweah No. 1 Powerhouse penstock was lengthened and realigned, with an extension linking in SCE's new facility. The powerhouse was equipped with an outdoor switchyard, reflecting general advances in switchyard design. Concurrent with the construction of the new Kaweah No. 1. Powerhouse, SCE replaced the last original generating unit in the Kaweah No. 2 Powerhouse with an Allis-Chalmers Unit, with this 1929 replacement in turn removed in 1947.²⁸



Figure 23: Kaweah Powerhouse No. 1, 1940
(Huntington Digital Library, SCE Photograph Collection, Call Number 02-27826)

²⁸ SCE Archives, Kaweah No. 1 Library, Three Rivers, SCE Drawing, "Kaweah No. 1 Station".

*Resource Name or # (Assigned by recorder)

D1. Historic Name: Kaweah Hydroelectric Project D2. Common Name: Kaweah Hydroelectric Project, FERC Project No. 298: Kaweah No. 3 Hydroelectric System Historic District

Other 1920s changes included upgrades to all system powerhouses that allowed for semi-automatic operation, thus allowing for generation without full-time station operators at each powerhouse. By the 1930s, the powerhouses were fully automatic, with all functions centrally managed. Additionally, SCE removed the original wood pole transmission lines, with the entire system upgraded to 66 kV lines and much of it carried by new steel cross-arm structures. The voltage was modest for the period and reflected the system's diminutive capacity in comparison to SCE's more substantial projects, most notably the Big Creek Hydroelectric System, which ran at 225 kV during the period.²⁹

The next major change to the system came in 1947, when the entirety of the 6-mile Kaweah No. 1 Flume was dismantled and reconstructed (**Figures 24 and 25**). The reconstruction came after years of ongoing maintenance to the original 1899 structure, with sections repaired on a yearly basis in nearly all years between 1925 and 1940. While the original flume was of a redwood design, with redwood planks joined by batten, the new flume was built of sheet metal coated in water durable asphalt, with a redwood substructure. The 1947 sheet metal structure remains in place; however, changes through the present have been extensive—many stemming from environmental damage, or as termed by one observer, “mother nature”. In 1986, handrails were added to the alignment, which have been serviced and replaced over time. In 1987, a forest fire burned 800 feet of the alignment. Between 1989 and 1991 much of the wood framing was rebuilt along the entirety of the alignment, with new stringers, legs, bracing, and pony bents. In 1991, a 30-foot section was washed out in a flood. Most recently, in 2018, sections of the alignment were damaged from a landslide, necessitating the rebuild of some sections, which has yet to occur (**Figure 26**). As such, the alignment is an amalgamation of materials dating from 1947-2018, following an alignment that was established in 1899. The wood portions of the Kaweah No. 2 Flume have also been replaced in this manner, with only the concrete sections reflective of the original materials.³⁰

In the latter decades of the twentieth century, maintenance has been continuous and ongoing throughout the system, with virtually all facilities continuously altered and upgraded to ensure operability. These physical changes are discussed in greater detail in the accompanying Primary and BSO Forms addressing each facility, and generally relate to all facets of the system's operation—from reconstruction of system diversions, flowlines, forebay apparatus, and generation and transmission equipment, to re-sheathing of the only remaining metal-clad powerhouse, Kaweah No. 1 Powerhouse. Such changes have served to keep the Kaweah Project operating efficiently and in accordance with current technological standards—and illustrate a system that is representative of both its nineteenth and early twentieth century development history and twenty-first century functions.

While material alterations under SCE ownership have done much to shape the physical components of the Kaweah Project over the last century, perhaps equally notable is the transition of the system from a nearly wholly dedicated regional agricultural utility to its current role as a minor component of the sprawling SCE

²⁹ SCE Archives, Kaweah No. 1 Library, Three Rivers, SCE Drawing, “Kaweah No. 2 Station” (GWO 10438); SCE Archives, Kaweah No. 1 Library, Three Rivers, SCE Drawing, “Kaweah No. 3 Station” (GWO 10439); SCE Archives, Kaweah No. 1 Library, Three Rivers, SCE Drawing, “Kaweah No. 3 Station” (GWO 026023); Polly Allen and Linda Pollack, National Register of Historic Places Nomination: Big Creek Hydroelectric System Historic District, written on behalf of SCE, 2016.

³⁰ SCE Archives, Kaweah No. 1 Library, Three Rivers, Kaweah No. 1 Flume Files.

*Resource Name or # (Assigned by recorder)

D1. Historic Name: Kaweah Hydroelectric Project D2. Common Name: Kaweah Hydroelectric Project, FERC Project No. 298: Kaweah No. 3 Hydroelectric System Historic District

energy grid, which is characterized by interconnected transmission corridors that link vast areas of California. In large, this transition is reflective of the evolution of the utility industry as a whole, as the consumption of energy supplies has evolved from a regional context to a large and interconnected statewide pool. At present, the 8.85 MW Kaweah Project is a small component of an SCE system that includes a 50,000 square-mile service territory, upwards of 15 million customers, and over 1,100 MW of power reserves. Within this modern utility context, however, the agricultural antecedents of the Kaweah Project remain a significant representation of California's historical development, with the nineteenth century vision of the Mount Whitney Power Company founders defining the transformative potential of irrigated agriculture. This vision remains a central component of California's physical identity to the present, with the San Joaquin Valley's sprawling fields, orchards, and dairies illustrative of the state's complex technological relationship with water.

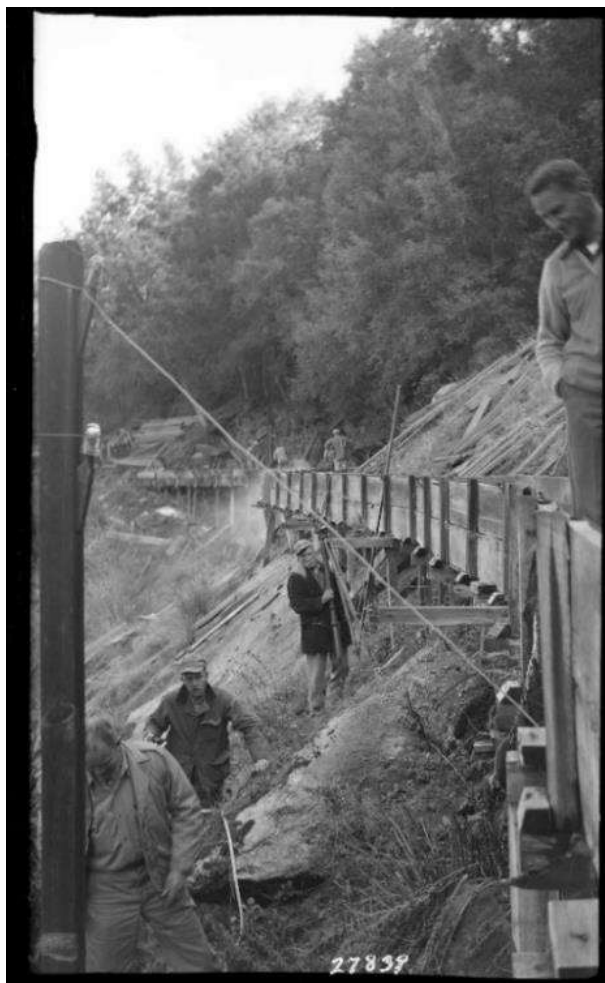

Figure 24: SCE Crews Rebuilding Kaweah No. 1 Flume, 1947
(Huntington Digital Library, SCE Photograph Collection, Call Number 02-27839)

*Resource Name or # (Assigned by recorder)

D1. Historic Name: Kaweah Hydroelectric Project D2. Common Name: Kaweah Hydroelectric Project, FERC Project No. 298: Kaweah No. 3 Hydroelectric System Historic District



Figure 25: Rebuilt Kaweah No. 1 Flume, 1948
(Huntington Digital Library, SCE Photograph Collection, Call Number 02-27830)

***Resource Name or # (Assigned by recorder)**

D1. Historic Name: Kaweah Hydroelectric Project D2. Common Name: Kaweah Hydroelectric Project, FERC Project No. 298: Kaweah No. 3 Hydroelectric System Historic District

NRHP and CRHR Evaluation

Previous Documentation

The majority of Kaweah Hydroelectric Project facilities documented herein have been previously surveyed and evaluated for NRHP eligibility as part of previous cultural resource documentation efforts. The previous survey and evaluation results were documented in a comprehensive single report: *A History and Significance Evaluation of the Kaweah Hydroelectric System, Tulare County, California*, authored by Lehman et al., on behalf of SCE in 1989.

In the 1989 documentation, the historic built environment features associated with the Kaweah No. 1 and Kaweah No. 2 portions of the Project were found ineligible for listing in the NRHP, largely because of a lack of physical integrity to convey significance. Conversely, the documentation found that select components of the Kaweah No. 3 system possessed significance and integrity as contributors to a historic district under Criteria A and C of the NRHP because of their associations with the development of hydroelectric capacity for agricultural pump irrigation (Criterion A) and their pioneering hydroelectric design (Criterion C). In this previous analysis, the district was referred to as the Kaweah No. 3 Hydroelectric System Historic District.

As documented in 1989, the components that were identified as eligible for the NRHP included the Kaweah No. 3 Powerhouse and Penstock (also determined individually eligible), the Marble Fork Flowline and Siphon, Middle Fork/ Kaweah No. 3 Flowline, and the Kaweah No. 3 Forebay. Remaining Kaweah No. 3 facilities, including the Middle Fork and Marble Fork Diversion Dams, were found ineligible because of a lack of integrity. The State Historic Preservation Officer (SHPO) concurred with all of the district eligibility findings in a letter dated March 21, 1990 (Letter Reference: FERC890210A).

An excerpt from the 1989 significance evaluation is provided below for reference:

The Kaweah Hydroelectric System is composed of many historic buildings and structures. Several of these resources represent the pioneering efforts of Mount Whitney Power Company to introduce electric power into the rural agricultural setting. Other elements of the system represent not early development, rather they are tied to the long period of operation, maintenance, and modification which has resulted in the present day configuration of the system.

Kaweah No. 1. Kaweah Powerhouse No. 1 is architecturally interesting, but not distinctive among other small powerhouse of its time of construction (1928-1929). While the powerhouse is the focal point of the Kaweah System, it is not representative of the original design or construction (either architecturally or technologically), since it replaced the original Powerhouse No. 1. As such these elements of the system do not appear to satisfy either Criterion A or Criterion C of the NRHP.

Kaweah No. 2. Built in 1905, Powerhouse No. 2 is also historically and architecturally interesting. The industrial architectural style of this structure is practical, and reflects the limited financial backing which Mount Whitney Power Company possessed in its early years. The construction materials are an interesting mix, with wood framing commonly used in industrial structures before 1900 and corrugated iron sheathing and roofing commonly used after 1900. It represents a transitional period in use of construction materials... While Powerhouse No. 2 is historically interesting it does not appear to embody the characteristics which would make it eligible under NRHP Criteria A or C. If particular importance

*Resource Name or # (Assigned by recorder)

D1. Historic Name: Kaweah Hydroelectric Project D2. Common Name: Kaweah Hydroelectric Project, FERC Project No. 298: Kaweah No. 3 Hydroelectric System Historic District

are the many significant modifications made to the generation equipment since the original date of construction (1913, 1929, 1947). The remaining associated historic structures, while little modified are not distinctive individually.

Kaweah No. 3. Kaweah Powerhouse No. 3, constructed in 1913, is historically and architecturally interesting. The industrial architectural style of this structure is attractive, and a good representation of early 20th century reinforced concrete construction. It represents increased prosperity for the Mount Whitney Power and Electric Company, when compared to the building materials used for Kaweah No. 1 and Kaweah No. 2. The integrity of the structure is excellent and in fine condition, having undergone virtually no alterations. For the most part it also contains the original powerhouse equipment...Kaweah No. 3's Marble and Middle Fork Conduits [Flowlines] possess substantial historical significance. Virtually no alterations have been made to the conduits since their construction, although regular repairs to washed out and leaking sections have been made. The dam and intake structures of both conduits underwent repairs in 1968, and at the same time retaining walls along the conduit to Kaweah No. 3 were repaired, but the conduit repairs in no way damaged nor detract from the original construction. These are especially unique engineering features, embodying a distinctive method of construction as well as being associated with events that have made significant contributions to the broad patterns of hydroelectric and irrigation history in California. They should be nominated for listing on the National Register of Historic Places under Criteria A and C.

Updated NRHP and CRHR Analysis

Because of the length of time that has passed since the previous recordation and the fact that the previous recordation did not formally inventory and evaluate some components of the Project because at the time the facilities were not yet 50 years of age, this district documentation provides an updated NRHP and CRHR evaluation to account for all historic period built environment resources associated with the Kaweah Hydroelectric Project, listed in **Table 1** of this District Record.

This updated evaluation generally agrees with the findings of the previous evaluation effort. As documented in the previous recordation, development of the Kaweah Hydroelectric Project from 1898 to the sale of the Project by the Mount Whitney Power Company in 1916 is reflective of a significant phase of development in both Tulare County and in California's hydroelectric development as a whole. The Kaweah developments of the Mount Whitney Power Company are significant under Criterion A for their association with the broad and significant pattern of agricultural expansion and development in Tulare County and the surrounding region. Under Criterion C, the development of the Kaweah Project is reflective of a significant type, period, and method of construction as a late nineteenth and early twentieth century hydroelectric facility.

Within this significant development context, this evaluation also concurs with the previous analysis that only built environment resources associated with the Kaweah No. 3 development retain sufficient system integrity to convey these significant development associations. Conversely, resources associated with the Kaweah No. 1 and No. 2 developments lack sufficient physical integrity to the potential period of significance to convey significant development associations through integrity of location, design, workmanship, materials, setting, feeling, and association. As such, this evaluation finds that only the Kaweah No. 3 Hydroelectric System historic period built environment resources appear eligible for listing in the NRHP as a historic district, with a period of significance spanning from construction in 1913 to sale of the company in 1916 to PLPC and a regional

***Resource Name or # (Assigned by recorder)**

D1. Historic Name: Kaweah Hydroelectric Project D2. Common Name: Kaweah Hydroelectric Project, FERC Project No. 298: Kaweah No. 3 Hydroelectric System Historic District

level of significance reflecting its Tulare County and San Joaquin Valley development associations. No other Kaweah Project facilities appear to contribute to this or any other NRHP or CRHR District, nor to possess significance as individual resources.

More detailed / updated NRHP analysis is included below, organized by development. For further documentation regarding all of the evaluated resources, please refer to the Primary and BSO records addressing each facility accompanying this record.

Kaweah No. 1 Development

None of the built environment resources associated with the Kaweah No. 1 development appear to be eligible for listing in the NRHP or CRHR, as individual resources or as contributors to a district. Although the Kaweah No. 1 development was the first development undertaken by the Mount Whitney Power Company in 1898-1899, and as such holds significant historical and contextual associations, virtually all vestiges of this nineteenth century era of development have been removed. Specifically, the powerhouse was demolished and reconstructed in a different location and form in 1929; the penstock was lengthened and largely rebuilt in 1929, 1967, 1984, and 1987; the Kaweah No. 1 Diversion Dam was largely rebuilt in 1940; the Kaweah No. 1 Flowline and the Kaweah No. 1 Forebay Tank were entirely reconstructed in 1947. As such, while the Kaweah No. 1 development has antecedents that relate to the significant development history of the Mount Whitney Power Company and California's pioneering electrical development, extant elements lack sufficient physical or operational fabric to convey these development associations through cohesive integrity of design, workmanship, materials, feeling, and association.

Under Criterion A, or CRHR Criterion 1, as a holistic operating system, the Kaweah No. 1 built environment resources are not physically associated with or representative of significant historical developments of the Mount Whitney Power Company or with the establishment of nineteenth century electrical systems in support of agricultural irrigation. Instead, the resources are largely reflective of multiple periods of twentieth century development under SCE. Within this twentieth century SCE context, the resources are not significant under Criterion A, as the maintenance and reconstruction of the Kaweah No. 1. Development was a small component of the company's extensive hydroelectric portfolio during the period and as such is not indicative of significant patterns of development or historical themes associated with company development or utility development in general.

Under Criterion B, or CRHR Criterion 2, none of the Kaweah No. 1 development built environment resources are directly associated with significant individuals related to either the corporate development of the Mount Whitney Power Company or the development of SCE. Because much of the physical fabric is not original to the nineteenth century period, the resources lack direct physical or operational association with the pioneering founders of the Mount Whitney Power Company. Additionally, there is no indication that they are associated with any notable figures in SCE's twentieth century development.

Under NRHP Criterion C, or CRHR Criterion 3, the Kaweah No. 1 built environment facilities are not reflective of a cohesive design or engineering that merits consideration under this Criterion in relation to individual or district eligibility. As discussed, virtually the entirety of the Kaweah No. 1 system was reconstructed between 1929 and the 1960s, with little engineering fabric that relates to initial development. Sole operational features that do relate to the initial Mount Whitney Power Company development period are limited to the Mineral

*Resource Name or # (Assigned by recorder)

D1. Historic Name: Kaweah Hydroelectric Project D2. Common Name: Kaweah Hydroelectric Project, FERC Project No. 298: Kaweah No. 3 Hydroelectric System Historic District

King Dams, constructed in 1903-1905 to modestly augment flows. As such, as an operating whole, extant elements of the system, while contextually associated with initial nineteenth century development, exist as an amalgam of materials and design, with insufficient integrity of materials, workmanship, design, feeling, and association to convey cohesive engineering or design themes under Criterion C.

Lastly, under Criterion D, or CRHR Criterion 4, information potential is limited as most materials do not date to any significant development period. As such, it is unlikely that resources would convey information regarding hydroelectric construction techniques that is not readily available in the archival record.

Kaweah No. 2 Development

None of the built environment resources associated with Kaweah No. 2 development appear to be eligible for listing in the NRHP or CRHR, as individual resources or as contributors to a district. Although the Kaweah No. 2 development was constructed in 1905 by the Mount Whitney Power Company, augmenting the generation capacity of the Powerhouse No. 1 development, a lack of cohesive physical integrity precludes eligibility for the NRHP or CRHR. While the powerhouse remains in the same location, the building has been entirely re-clad in modern metal siding and the original turbines and generators have been replaced, with generating equipment reconfigured and replaced in 1913, 1929, and 1947. The Kaweah No. 2 Diversion Dam was largely rebuilt in 1938 and 2012-2013, resulting in a dam that functions and appears as a modern diversion rather than the original granite masonry dam. While the Kaweah No. 2 Flowline follows the same alignment as constructed, the facility was rebuilt with new trestle structures and half-round metal in 1948, entirely replacing the original redwood flume design. As such, while this portion of the Project has some physical components that relate to the continuing development of the Mount Whitney Power Company in the early twentieth century, these extant elements lack sufficient physical or operational fabric to convey these development associations through cohesive integrity of design, workmanship, materials, feeling, and association.

Under Criterion A, or CRHR Criterion 1, as a whole, the Kaweah No. 2 built environment resources are not physically associated with or representative of significant historical developments of the Mount Whitney Power Company or with the establishment of early twentieth century electrical systems in support of agricultural irrigation. Instead, the resources are largely reflective of multiple periods of twentieth century development under SCE. Within this twentieth century SCE context, the resources are not significant under Criterion A, as the maintenance and reconstruction of the Kaweah System was a small component of the company's extensive hydroelectric portfolio during the period and as such is not indicative of significant patterns of development or historical themes associated with company development or utility development in general.

Under Criterion B, or CRHR Criterion 2, none of the Kaweah No. 2 built environment resources are directly associated with significant individuals related to either the development of the Mount Whitney Power Company or the evolution of SCE. Because much of the physical fabric is not original to the initial development period, resources lack direct physical association with the pioneering founders of the Mount Whitney Power Company. Additionally, there is no indication that they are associated with any notable figures in SCE's twentieth century development.

***Resource Name or # (Assigned by recorder)**

D1. Historic Name: Kaweah Hydroelectric Project D2. Common Name: Kaweah Hydroelectric Project, FERC Project No. 298: Kaweah No. 3 Hydroelectric System Historic District

Under NRHP Criterion C, or CRHR Criterion 3, the Kaweah No. 2 built environment facilities are not reflective of a cohesive design or engineering that merits consideration under this Criterion in relation to individual or district eligibility. As discussed, much of the Kaweah No. 2 system has been reconstructed through the mid-twentieth century to the present, with little engineering fabric that relates to initial development. As such, extant elements of the system exist as an amalgam of materials and design, with insufficient integrity of materials, workmanship, design, feeling, and association to convey cohesive engineering or design themes under Criterion C.

Lastly, under Criterion D, or CRHR Criterion 4, information potential is limited as most materials do not date to any significant development periods. As such, it is unlikely that resources would convey information regarding hydroelectric construction techniques that is not readily available in the archival record.

Kaweah No. 3 Development

Consistent with the previous evaluation analysis, this updated documentation finds that built environment resources associated with the Kaweah No. 3 development appear to be eligible for listing in the NRHP and CRHR individually and as contributors to the Kaweah No. 3 Hydroelectric System Historic District under Criteria A and C (CRHR Criteria 1 and 3) (see District Map on Page 5 of District Record and Facility Location Maps on DPR 523 J for each facility). Constructed by the Mount Whitney Power Company in 1913 as the final component of the Kaweah Hydroelectric System, Powerhouse No. 3 and its associated diversion and water conveyance facilities were representative of both a maturing Mount Whitney Power Company and a rapidly advancing utility industry as a whole, with the design and engineering of this era of the system representative of important advances in hydroelectric development. In addition to this overall historical and engineering significance, built environment resources associated with Kaweah No. 3 retain strong physical and operational integrity—with contributing facilities readily conveying their historical associations through their physical fabric and operational design. The powerhouse, two diversions, multi-component water conveyance flowline, and storage forebay all retain strong integrity of materials, workmanship, design, location, setting, feeling, and association that serves to convey their historical associations as an intact and integrated early twentieth century hydroelectric system.

Under Criterion A, CRHR Criterion 1, the Kaweah No. 3 Hydroelectric System Historic District is associated with the significant Tulare County developments of the Mount Whitney Power Company, which transformed the region through their advancement of pump irrigation and provided a model for the utility industry that demonstrated the immense importance of the agricultural market in hydroelectric development. Prior to Mount Whitney Power Company's development of the Kaweah Project, the nascent hydroelectric industry had focused largely upon urban and industrial development, with the earliest projects seeking to connect California's growing urban sphere. In contrast to this emphasis, the Kaweah System developed by Mount Whitney focused almost exclusively upon agriculture, stemming from the belief that California's Mediterranean Valley climate could be transformed through systematic application of electrically pumped water. By the 1910s, this pioneering effort had transformed swaths of the San Joaquin Valley and permeated the business plans of the hydroelectric industry, with leading companies including SCE, PG&E, San Joaquin Light and Power Company, and others incorporating the agricultural market as a vital component of their consumer portfolio.

*Resource Name or # (Assigned by recorder)

D1. Historic Name: Kaweah Hydroelectric Project D2. Common Name: Kaweah Hydroelectric Project, FERC Project No. 298: Kaweah No. 3 Hydroelectric System Historic District

Under NRHP Criterion C, CRHR Criterion 3, the contributors of the Kaweah No. 3 Hydroelectric System Historic District are significant material representatives of 1910s hydroelectric engineering. In contrast to the earlier Powerhouse No. 1 and No. 2, Powerhouse No. 3 was designed as a substantial reinforced concrete classical powerhouse, evoking both the increased stature of the company and the heightened design sensibilities of the industry as a whole. By 1913, hydroelectric construction had acquired a far more advanced stylistic form, with powerhouses increasingly designed to evoke stability and civilizing forces through their architectural form. While Mount Whitney Power Company's Powerhouse No. 3 was spare and restrained in its design and modest in comparison to other notable developments during the period, the building conveys this important stylistic advancement. Similarly, the system's diversions and flowlines are representative of important innovations in water diversion and conveyance. The interconnected Marble Fork and Middle Fork Flowlines represented an increasingly complex conveyance engineering, with the waters of the Marble and Middle Forks intermingled through the placement of a comingling siphon and the flowlines constructed of jointed concrete panels for much of the alignment. This innovative concrete construction was a notable departure from the wood flumes developed in earlier eras and is representative of both improved concrete engineering and improved construction capacity, with all concrete developed in the field through an intensive process of site hauling and staging.

While the Kaweah No. 3 Hydroelectric System Historic District appears eligible under NRHP Criteria A and C, CRHR Criteria 1 and 3, it does not appear to be eligible under Criterion B or D. The district's significance does not stem from direct associations with significant individuals, with its significance instead derived from the agriculturally focused developments of the Mount Whitney Power Company and its hydroelectric design — both of which are better encapsulated under Criteria A and C. Under Criterion D, the contributing resources of the district are well documented in archival literature and engineering documentation and it does not appear that the resources have the potential to provide additional important information in this regard.

All contributing components of the district retain strong physical integrity in relation to all aspects of integrity recognized by the NRHP. The system retains strong integrity of location, with the contributing resources of the district remaining in the same location and exhibiting the same spatial and operating relationships as developed in the period of significance. The district retains high integrity of design, with all contributing resources conveying significant design features, through their physical form, structural and operational plan, and engineering design. Importantly, material alterations and maintenance have generally left key historic period design features in place, including massing, plan, and physical detailing, with contributing resources displaying integrity through their historic period engineering and aesthetic design features. The setting of the resources retains strong integrity, with the hydroelectric facilities integrated into the surrounding landscape in a way that reflects continuity of operation and design. The system's materials retain high integrity to the period of significance. The powerhouse was primarily constructed of concrete and steel; flowlines of concrete ditch and buttressed concrete panels; and dams of concrete, rock, and steel. In most senses, the bulk of this original material remains, with only modest alterations to that which was initially developed. The District's complex integration within the framing natural environment conveys a strong sense of workmanship that retains high integrity. The Project was designed to harness natural forces related to hydrology and environmental terrain to generate electricity. This energy transfer was accomplished by strategically placed diversions, flowlines, and a lower elevation powerhouse, which together continue to convey a sense of industrial workmanship in relation to this overall task. Lastly, because the Kaweah No. 3 development has continued to operate in much the same

*Resource Name or # (Assigned by recorder)

D1. Historic Name: Kaweah Hydroelectric Project D2. Common Name: Kaweah Hydroelectric Project, FERC Project No. 298: Kaweah No. 3 Hydroelectric System Historic District

manner as it was designed with much of the same materials, the district readily conveys significance through strong integrity of feeling and association. Through this overall physical integrity, contributing elements of the district convey a strong sense of time and place and illustrate the system's significant themes of development.

The Kaweah No. 3 Hydroelectric System Historic District retains a spectrum of key physical features, spatial relationships, and operational linkages that enable the district to convey significance as a 1910s hydroelectric development. The character defining features of the district are summarized below, with detailed character defining features for all contributing resources detailed on the accompanying Primary and BSO records addressing each facility.

- Cohesive functional and operational linkages between hydroelectric resources.
- A surrounding terrain that is characterized by mountainous exposures, forested hillsides, and a generally rugged, undeveloped surrounding landscape context.
- An engineering and operational plan that is characterized by substantial distances between resources and a linear operational relationship that extends from the diversion facilities to the Kaweah No. 3 Powerhouse.
- A range of industrial property types, including diversions, a siphon, interconnected flowlines, a forebay, and the powerhouse and penstock that exhibit differing materials, massing, and structures but are bound by a common operating framework.
- A powerhouse design and form that fuses industrial mandates with key architectural allusions in the Classical Revival style.
- Project features that are deeply integrated to surrounding landscape, with diversions conforming to the river channels, flowlines following natural contours, and the powerhouse and penstock placement relating to the vertical distance of the framing hillside.

While the previous evaluation found that the Kaweah No. 3 Powerhouse was individually eligible in addition to being eligible as a contributor to the Kaweah No. 3 Hydroelectric System Historic District, this documentation finds that the building's significance is better conveyed through its district associations and that the resource does not appear to be individually eligible. In and of itself, the powerhouse is representative of a modest design and engineering that was not ground-breaking in its individual form or capacity. The powerhouse's turbines, generators, penstocks, and transmitting voltage were all in keeping with established norms of the period and do not convey any singular advances in operational design. Similarly, while the general classic overtones of the building represented an advance for Mount Whitney Power Company, they are not reflective of significant design advance, with concurrent construction, most notably PLPC's Big Creek No. 1 and No. 2 on the San Joaquin River, far more advanced in their design sensibilities. Within this larger context, the significance of the Kaweah No. 3 Powerhouse is its contributing role within the context of the Kaweah No. 3 development, which was constructed as a cohesive and interrelated water conveyance and generation system that diverted the waters of the Marble and Middle Forks of the Kaweah River for the region's growing agricultural consumption.

Lastly, while the previous evaluation found that the Marble and Middle Fork Diversion Dams did not contribute to the significance of the Kaweah No. 3 Hydroelectric System Historic District, this updated

*Resource Name or # (Assigned by recorder)

D1. Historic Name: Kaweah Hydroelectric Project D2. Common Name: Kaweah Hydroelectric Project, FERC Project No. 298: Kaweah No. 3 Hydroelectric System Historic District

evaluation finds that the two diversion dams do contribute to the district through their functional design and development associations. The dams are an instrumental part of the operational system, acting as the conveyance entry point for flows that ultimately reach the powerhouse turbines. While they have been subject to limited concrete repair and maintenance, both dams are able to convey their significant associations through their intact physical form.

Built Environment Resources Associated with General Project Operations

The Kaweah Hydroelectric Project includes two classes of historic period general support facilities that were evaluated for NRHP and CRHR eligibility as part of this District documentation. The first class of resources consists of eight Project Stream Gages, which are dispersed throughout the Project to measure flows. While only one of these gages dates to the historic period, Gage 201, as a class of general support resources this property type appears ineligible for listing in the NRHP or CRHR under any of the criteria for listing. As a whole, the gages are standardized in construction and function and are regularly replaced and as monitoring requirements and technological upgrades dictate. Under Criterion A, CRHR Criterion 1, the gages are general utility support features that are not emblematic of or associated with significant late nineteenth or early twentieth century development of the Project. Under Criterion B, CRHR Criterion 2, they are not associated with significant individuals in either Mount Whitney Power Company's or SCE's development. Under Criterion C, CRHR Criterion 3, they are standardized in plan and entirely lack historic fabric that dates to any period of significance. Lastly, under Criterion D, CRHR Criterion 4, the gages are a well-documented utility type that possesses low information potential beyond their water gaging records.

The second class of resources consist of Project transmission, distribution, and fiber lines, which are dispersed throughout the Kaweah Project to transmit generated power from the Project and support Project operations. As a class of general support resources this property type appears ineligible for listing in the NRHP or CRHR. As a whole, the transmission, distribution, and fiber lines are standardized in construction and function and are regularly replaced and upgraded for continued operation, with appurtenant features including poles, conductors, and control switches ranging in age and materials from the mid-twentieth century to the 2010s. Under Criterion A, CRHR Criterion 1, the transmission, distribution, and fiber lines are general utility support features that are not emblematic of or associated with significant late nineteenth or early twentieth century development of the Project. Under Criterion B, CRHR Criterion 2, they are not associated with significant individuals in either Mount Whitney Power Company's or SCE's development. Under Criterion C, CRHR Criterion 3, they are standardized in plan and design. As initially developed, the transmission lines were wood pole lines that typified the era in which they were constructed with both the initial voltage for the Project and the transition to 66 kV not representative of innovative transmission capacities. Further, all original material that dates to the late nineteenth or early twentieth century has been replaced, with all extant towers and poles modern in materials. Lastly, under Criterion D, CRHR Criterion 4, this type of resource is a well-documented utility type that possesses low information potential related to transmission design or construction. This evaluation of this property type is in keeping with evaluation standards developed for SCE transmission, subtransmission, and distribution property types, which delineates evaluation procedures and generally excludes wood pole transmission lines from NRHP or CRHR consideration.³¹

³¹ Historic-Era Electrical Infrastructure Management Program," drafted by Southern California Edison Company, August 2015, 86-91.

*Resource Name or # (Assigned by recorder)

D1. Historic Name: Kaweah Hydroelectric Project D2. Common Name: Kaweah Hydroelectric Project, FERC Project No. 298: Kaweah No. 3 Hydroelectric System Historic District

Documentation Conclusions

The purpose of this District Record was to document all facilities associated with the Kaweah Hydroelectric Project, develop a historic context for the Project as a whole, and evaluate all components of the Project for both district and individual NRHP eligibility. Based on the evaluation herein, analysis concludes that select portions of the Kaweah Hydroelectric Project contribute to an NRHP and CRHR Historic District: The Kaweah No. 3 Hydroelectric System Historic District. Contributors to the district are listed in **Table 2** of this record. As described herein, no other Kaweah Hydroelectric Project facilities appear individually eligible for the NRHP or CRHR or to contribute to a historic district because of a lack of integrity. Representative photographs for all Kaweah No. 3 Hydroelectric System Historic District contributors are included on the following pages of this District Record. Detailed documentation for both Kaweah No. 3 Hydroelectric System Historic District contributors and facilities that were not found to contribute to any district are included in accompanying Primary and BSO forms.

Page 44 of 199

*NRHP Status Code:

*Resource Name or # (Assigned by recorder)

D1. Historic Name: Kaweah Hydroelectric Project D2. Common Name: Kaweah Hydroelectric Project, FERC Project No. 298: Kaweah No. 3 Hydroelectric System Historic District

Kaweah No. 3 Hydroelectric System Historic District Representative Photographs:



Photograph 2. Marble Fork Diversion Dam, camera facing north. April 17, 2018.



Photograph 3. Marble Fork Flowline, camera facing southwest. April 17, 201.

Page 45 of 199

*NRHP Status Code:

*Resource Name or # (Assigned by recorder)

D1. Historic Name: Kaweah Hydroelectric Project D2. Common Name: Kaweah Hydroelectric Project, FERC Project No. 298: Kaweah No. 3 Hydroelectric System Historic District



Photograph 4. Marble Fork Siphon, camera facing east. April 17, 2018.



Photograph 5. Junction of Marble Fork Siphon and Middle Fork Flowline, camera facing east, April 17, 2018.

Page 46 of 199

*NRHP Status Code:

*Resource Name or # (Assigned by recorder)

D1. Historic Name: Kaweah Hydroelectric Project D2. Common Name: Kaweah Hydroelectric Project, FERC Project No. 298: Kaweah No. 3 Hydroelectric System Historic District



Photograph 6. Middle Fork Diversion Dam, camera facing east, April 17, 2018.



Photograph 7. Middle Fork Flowline, camera facing south, April 17, 2018.

Page 47 of 199

*NRHP Status Code:

*Resource Name or # (Assigned by recorder)

D1. Historic Name: Kaweah Hydroelectric Project D2. Common Name: Kaweah Hydroelectric Project, FERC Project No. 298: Kaweah No. 3 Hydroelectric System Historic District



Photograph 8. Kaweah No. 3 Forebay, camera facing east, April 17, 2018.



Photograph 9. Kaweah No. 3 Powerhouse, camera facing northeast, April 17, 2018.

State of California - The Resources Agency
DEPARTMENT OF PARKS AND RECREATION
PRIMARY RECORD

Primary #
HRI #
Trinomial
NRHP Status Code

Other Listings _____
Review Code _____ Reviewer _____ Date _____

Page 48 of 199

*Resource Name or #: (Assigned by recorder) Kaweah No. 1 Powerhouse

P1. Other Identifier: _____

*P2. Location: Not for Publication Unrestricted *a. County Tulare

and (P2c, P2e, and P2b or P2d. Attach a Location Map as necessary.)

*b. USGS 7.5' Quad Case Mountain, Calif. Date 1987 T 16S; R 28E Sec 8; M.D. B.M.

e. Address 44511 Sierra Dr. City Three Rivers, CA Zip 93271

f. UTM: (Give more than one for large and/or linear resources) Zone 11S, 333169.06 mE/ 4037170.50 mN

g. Other Locational Data: (e.g., parcel #, directions to resource, elevation, decimal degrees, etc., as appropriate)

Kaweah No. 1 Powerhouse is located approximately 200 feet west of State Route 198 at the end of a driveway along the Kaweah River.

*P3a. Description: (Describe resource and its major elements. Include design, materials, condition, alterations, size, setting, and boundaries)

Kaweah No. 1 Powerhouse is a small, single story building located on the south bank of the Kaweah River (**Photograph 1**). This form inventories the Kaweah No. 1 Powerhouse as well as its associated penstock and transmission yard. Originally constructed in 1899 as a corrugated metal building, the powerhouse was relocated approximately 100 feet north in 1929 and a new concrete powerhouse constructed (**Photograph 2**). The current rectangular plan powerhouse is constructed of reinforced, board formed concrete and measures approximately 28 feet long by 24 feet wide. The building has a flat asphalt roof with a three-foot parapet featuring a simple frieze on all sides, with "Southern California Edison Company engraved on its front (east) side (**Photograph 3 and 5**). Fenestration consists of bands of metal sash, multi-light industrial windows with central hopper windows situated near the base of the parapet on all sides (see Continuation Sheet).

*P3b. Resource Attributes: (List attributes and codes) HP11 – Engineering structure

*P4. Resources Present: Building Structure Object Site District Element of District Other (Isolates, etc.)

P5a. Photograph or Drawing (Photograph required for buildings, structures, and objects.)



*P5b. Description of Photo: (view, date, accession #) Photograph 1 Kaweah No. 1 Powerhouse, camera facing southwest, May 8, 2018.

*P6. Date Constructed/Age and Source: Historic Prehistoric Both 1928-1929 (SCE)

*P7. Owner and Address: Southern California Edison
1515 Walnut Grove Avenue
Rosemead, CA 91770

*P8. Recorded by: (Name, affiliation, and address) Matt Walker and Polly Allen
Cardno, Inc.
2890 Gateway Oaks Dr., Suite 200
Sacramento, CA 95833

*P9. Date Recorded: April 18, May 8, 2018

*P10. Survey Type: (Describe) Intensive

*P11. Report Citation: (Cite survey report and other sources, or enter "none.")

CUL-1: Built Environment Technical Study Report, Kaweah Hydroelectric Project, FERC Project No. 298, January 2019

*Attachments: NONE Location Map Continuation Sheet Building, Structure, and Object Record
 Archaeological Record District Record Linear Feature Record Milling Station Record Rock Art Record
 Artifact Record Photograph Record Other (List):

State of California - The Resources Agency
DEPARTMENT OF PARKS AND RECREATION HRI# Primary #
BUILDING, STRUCTURE, AND OBJECT RECORD

*Resource Name or # (Assigned by recorder) Kaweah No. 1 Powerhouse

*NRHP Status Code

Page 49 of 199

- B1. Historic Name: Kaweah No. 1 Powerhouse
B2. Common Name: Kaweah No. 1 Powerhouse
B3. Original Use: Powerhouse B4. Present Use: Powerhouse

*B5. Architectural Style: Classical Revival

*B6. Construction History: (Construction date, alterations, and date of alterations) Original corrugated metal powerhouse constructed in 1898 and replaced in 1928 with the current Classical Revival building. In 1929, the original penstock was extended to enter the new powerhouse. In 1930, a door opening was cut in the rear of the building. Original lamps on front of building replaced ca. 1899. Tailrace channel constructed in 1991.

*B7. Moved? No Yes Unknown Date: _____ Original Location:

*B8. Related Features: Kaweah Hydroelectric Project (see accompanying records)

B9a. Architect: Southern California Edison Company

b. Builder: Unknown

*B10. Significance: Theme n/a Area n/a Period of Significance n/a

Property Type n/a Applicable Criteria n/a

(Discuss importance in terms of historical or architectural context as defined by theme, period, and geographic scope. Also address integrity.)

Kaweah No. 1 Powerhouse does not appear to meet the criteria for listing in the National Register of Historic Places (NRHP) or the California Register of Historical Resources (CRHR) as an individual property or as a contributor to any NRHP or CRHR Historic District. Because Kaweah Powerhouse No. 1 is an operational element of the Kaweah Hydroelectric Project, which includes three operationally related hydroelectric systems, the facility was evaluated for NRHP and CRHR eligibility within the context of the larger operational hydroelectric system. Please see attached District Record for full historic context and evaluation of Kaweah No. 1 Powerhouse. Please refer to accompanying Continuation Sheets for full description of the facility.

B11. Additional Resource Attributes: (List attributes and codes)

*B12. References: See Footnotes

B13. Remarks:

*B14. Evaluator: Polly Allen and Matt Walker, Cardno

*Date of Evaluation: December 2018

This space reserved for official comments.



Other Listings _____
Review Code _____ Reviewer _____ Date _____

P1. Other Identifier: _____

P3a. Description (Continued):

The building's primary entrance consists of a set of modern metal double doors with a metal security gate flanked by metal utility lamps on each side of the door. A small sliding metal door is situated beside the main entrance.

The Kaweah No. 1 Penstock extends 3,340 feet down a steep rocky hillside from the Kaweah No. 1 Forebay, passing under State Route 198, and enters the powerhouse on its south side (**Photograph 4**). The buried steel pipe varies in diameter from 19 to 48 inches. After the penstock enters the powerhouse, water passes through a single Allis-Chalmers impulse turbine (**Photograph 5**). An 8-ton hand operated traveling steel crane provides hoisting facilities for equipment within the powerhouse. The facility's control and relay panel is located in the southeast corner of the building. Water exits the powerhouse through a simple modern concrete tailrace channel extending from the building's northwest corner, returning the diverted water to the Kaweah River (**Photograph 6 and 10**). Two modern metal air ducts project from the building's north side beside the tailrace.

The Kaweah No. 1 Switchyard is located on a ridge just above the powerhouse (**Photograph 7**). The electricity generated in the powerhouse is transferred to the switchyard through steel conduit running up the slight slope to the switchyard. The outdoor facility contains support equipment for electrical transfer, including a prominent overhead bus structure, three oil circuit breakers and associated single phase lightning arresters, and a single three phase transformer. All equipment is stationed on concrete foundations and the yard is enclosed by a six foot galvanized cyclone fence.



Photograph 2. Original corrugated metal powerhouse, 1904 (Huntington Library, Call Number 04 - 00041).

Other Listings _____
Review Code _____ Reviewer _____ Date _____

P1. Other Identifier: _____

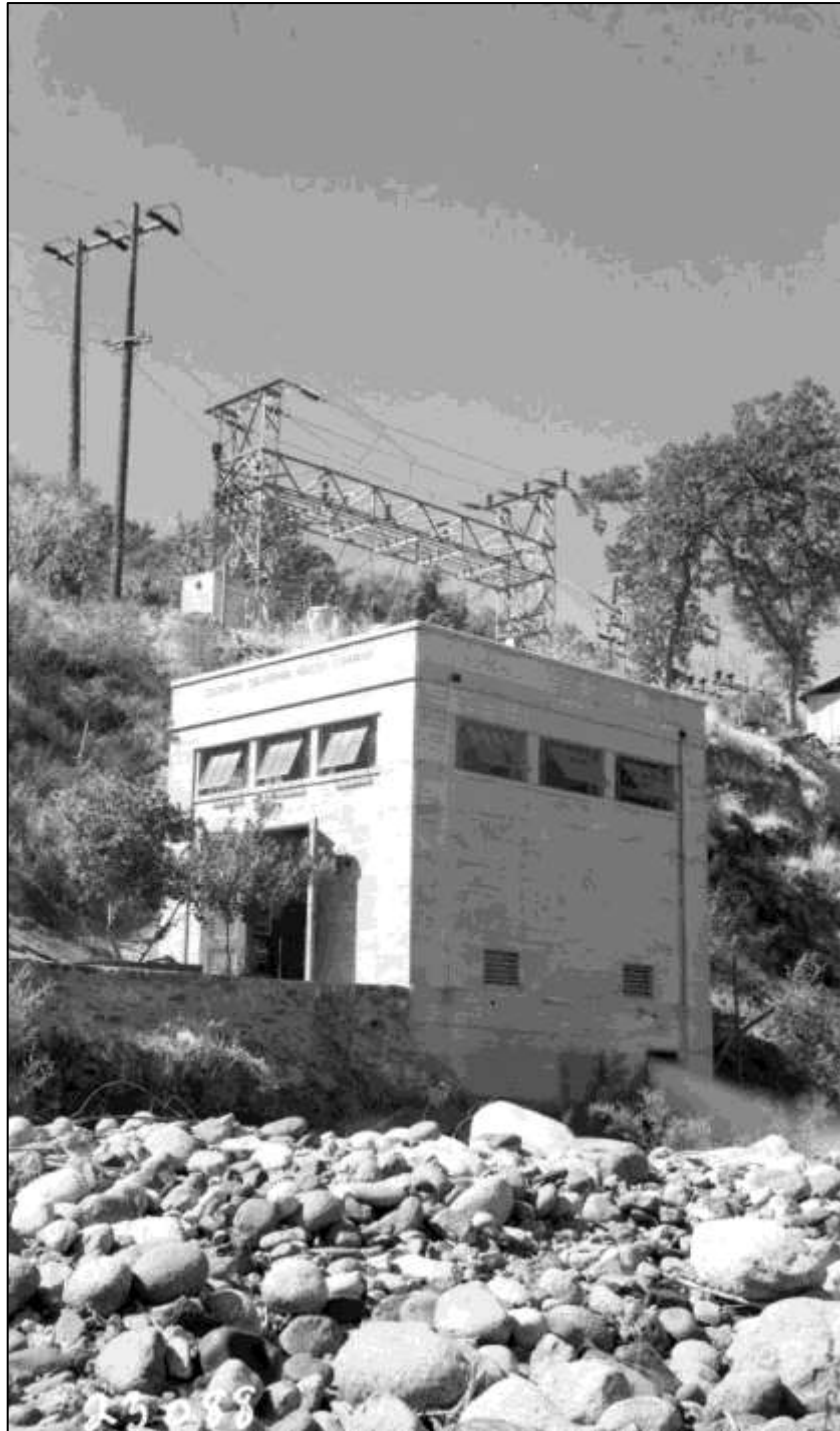

Photograph 3. Kaweah No. 1 Powerhouse and Substation, 1940 (Huntington Library, Call Number 02 - 23088).

Other Listings _____
Review Code _____ Reviewer _____ Date _____

P1. Other Identifier: _____



Photograph 4. Kaweah No. 1 Penstock alignment, camera facing southeast, May 8, 2018.



Photograph 5. Interior of powerhouse showing generator, turbine, and penstock, camera facing west, April 18, 2018.

Other Listings _____
Review Code _____ Reviewer _____ Date _____

P1. Other Identifier: _____

Photographs (Continued):



Photograph 6. Concrete tailrace channel under construction, 1991 (SCE).



Photograph 7. Kaweah No. 1 Switchyard, camera facing northeast, May 18, 2018.

Other Listings _____
Review Code _____ Reviewer _____ Date _____

P1. Other Identifier: _____



Photograph 8. West side of Kaweah No. 1 Powerhouse, camera facing west, April 18, 2018.



Photograph 9. North side of powerhouse showing air ducts, camera facing south, April 18, 2018.

Other Listings _____
Review Code _____ Reviewer _____ Date _____

P1. Other Identifier: _____



Photograph 10. Concrete tailrace channel, April 18, 2018.

Other Listings _____
Review Code _____ Reviewer _____ Date _____

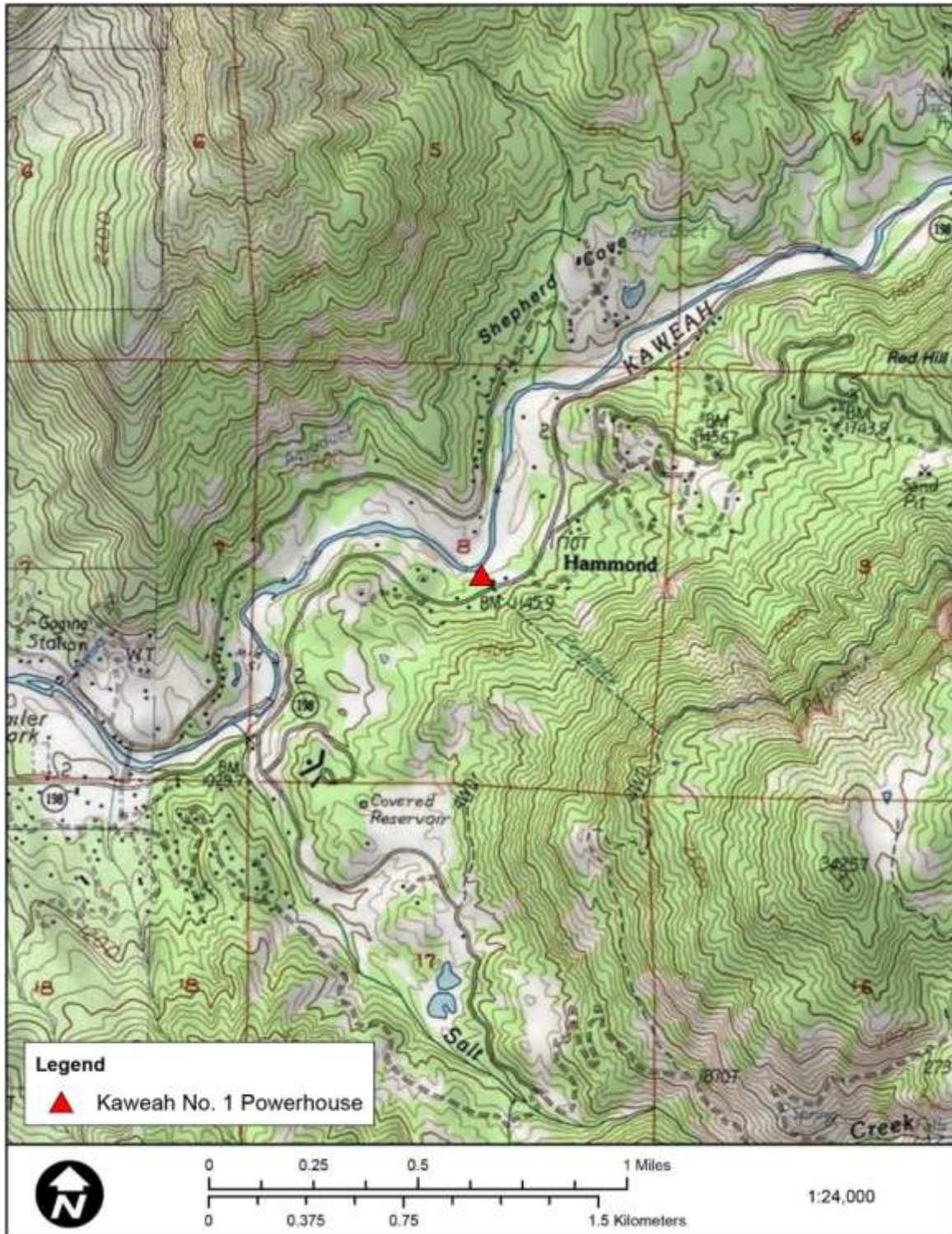

State of California - The Resources Agency
DEPARTMENT OF PARKS AND RECREATION
PRIMARY RECORD

Primary #
HRI #
Trinomial
NRHP Status Code

Other Listings _____
Review Code _____ Reviewer _____ Date _____

Page 57 of 199

*Resource Name or #: (Assigned by recorder) Kaweah No. 1 Diversion

P1. Other Identifier: _____

*P2. Location: Not for Publication Unrestricted *a. County Tulare

and (P2c, P2e, and P2b or P2d. Attach a Location Map as necessary.)

*b. USGS 7.5' Quad Case Mountain, Calif. Date 1987 T 16S; R 29E Sec 14; M.D. B.M.

h. Address City Zip

i. UTM: (Give more than one for large and/or linear resources) Zone 11S, 339645.41 mE/ 4035530.31 mN

j. Other Locational Data: (e.g., parcel #, directions to resource, elevation, decimal degrees, etc., as appropriate)

Kaweah No. 1 Diversion Dam is accessed by walking the Kaweah No. 1 Flowline approximately 1,500 feet east from Kaweah Bridge on Mineral King Road, approximately 6.5 miles east of State Route 198.

*P3a. Description: (Describe resource and its major elements. Include design, materials, condition, alterations, size, setting, and boundaries)

The Kaweah No. 1 Diversion is located in the steep, rocky canyon of the East Fork Kaweah River, approximately four miles east of State Route 198. This form inventories the Kaweah No. 1 Diversion, including the Kaweah No. 1 Diversion Dam as well as its associated intake structure. Situated at an elevation of 2,583 feet, the Kaweah No. 1 Diversion Dam is a simple six-foot tall overflow concrete gravity dam with a crest length of 20 feet (**Photograph 1**). The dam impounds water for diversion into a six-foot tall by three-foot wide unlined granite tunnel, with flow controlled by a manually operated metal slide gate (**Photograph 2**). The tunnel extends approximately 50 feet west, flowing through a large granite boulder, and empties into a sandbox, or sediment trap (**Photograph 3**) (see Continuation Sheet).

*P3b. Resource Attributes: (List attributes and codes) HP11 – Engineering structure; HP21 – Dam

*P4. Resources Present: Building Structure Object Site District Element of District Other (Isolates, etc.)

P5a. Photograph or Drawing (Photograph required for buildings, structures, and objects.)



P5b. Description of Photo: (view, date, accession #) Photograph 1 Kaweah No. 1 Diversion, camera facing southwest, April 19, 2018.

*P6. Date Constructed/Age and Source: Historic Prehistoric Both
1898; 1940 (SCE)

*P7. Owner and Address:
Southern California Edison
1515 Walnut Grove Avenue
Rosemead, CA 91770

*P8. Recorded by: (Name, affiliation, and address)
Matt Walker and Polly Allen
Cardno, Inc.
2890 Gateway Oaks Dr., Suite 200
Sacramento, CA 95833

*P9. Date Recorded: April 19, 2018

*P10. Survey Type: (Describe) Intensive

*P11. Report Citation: (Cite survey report and other sources, or enter "none.")

CUL-1: Built Environment Technical Study Report, Kaweah Hydroelectric Project, FERC Project No. 298, January 2019

*Attachments: NONE Location Map Continuation Sheet Building, Structure, and Object Record
 Archaeological Record District Record Linear Feature Record Milling Station Record Rock Art Record
 Artifact Record Photograph Record Other (List):

State of California - The Resources Agency
DEPARTMENT OF PARKS AND RECREATION
BUILDING, STRUCTURE, AND OBJECT RECORD

Primary #

HRI#

*Resource Name or # (Assigned by recorder) Kaweah No. 1 Diversion

*NRHP Status Code

Page 58 of 199

B1. Historic Name: Kaweah No. 1 Diversion
B2. Common Name: Kaweah No. 1 Diversion
B3. Original Use: Dam B4. Present Use: Dam

*B5. Architectural Style: Granite Masonry

*B6. Construction History: (Construction date, alterations, and date of alterations) Kaweah No. 1 Diversion originally constructed in 1899. Current concrete sandbox constructed circa 1940.

*B7. Moved? No Yes Unknown Date: _____ Original Location:

*B8. Related Features: Kaweah Hydroelectric Project (see accompanying records)

B9a. Architect: Mount Whitney Power Company; Southern California Edison Company

b. Builder: Unknown

*B10. Significance: Theme n/a Area n/a Period of Significance n/a Property Type n/a Applicable Criteria n/a
(Discuss importance in terms of historical or architectural context as defined by theme, period, and geographic scope. Also address integrity.)

Kaweah No. 1 Diversion does not appear to meet the criteria for listing in the National Register of Historic Places (NRHP) or the California Register of Historical Resources (CRHR) as an individual property or as a contributor to any NRHP or CRHR Historic District. Because Kaweah No. 1 Diversion is an operational element of the Kaweah Hydroelectric Project, which includes three operationally related hydroelectric systems, the facility was evaluated for NRHP and CRHR eligibility within the context of the larger operational hydroelectric system. Please see attached District Record for full historic context and evaluation of Kaweah No. 1 Diversion. Please refer to accompanying Continuation Sheets for full description of the facility.

B11. Additional Resource Attributes: (List attributes and codes)

*B12. References: See footnotes

B13. Remarks:

*B14. Evaluator: Polly Allen and Matt Walker, Cardno

*Date of Evaluation: December 2018

This space reserved for official comments.

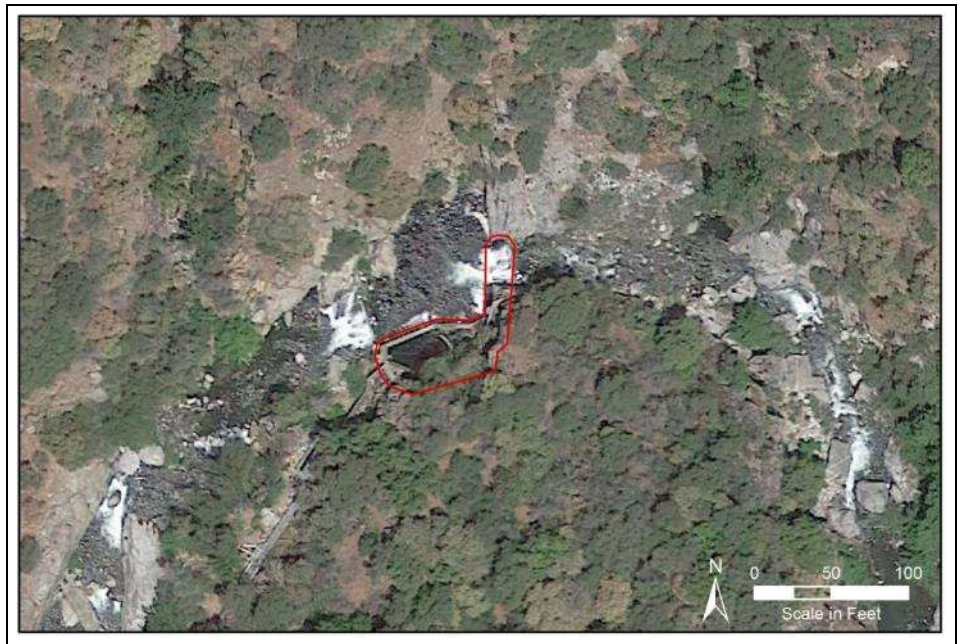

CONTINUATION SHEET

Property Name: Kaweah No. 1 Diversion

Page 59 of 199

P3a. Description (Continued):

The triangular shaped sandbox has board formed concrete walls, with a rock wall section, and an ungated overflow spillway crest. The sandbox is accessed using a board platform with tubular metal hand railings, with a short flight of stairs leading to the intake control. A small concrete diversion structure projects from the hillside near the center of the sandbox. Two manually controlled sluice gates near the structure's east and west ends allow control of the water level within the sandbox (**Photograph 4** and **5**). A large metal pipe, formerly used as a fish passage, protrudes from near the center of the structure's concrete wall (**Photograph 6**). Water flows through a large metal trash rack before passing through a metal radial slide gate into a short flume section (**Photograph 7**). Water then passes through a large fish wheel before flowing into an extended modern PVC pipe protected by a modern concrete wall, through a concrete block gauge house with a shed roof, and into the Kaweah No. 1 Flowline. A modern concrete-walled spillway allows for release of water from the pipe (**Photograph 8 and 9**). See figures for historic period imagery of the facility.



Figure 1. Kaweah No. 1 Diversion Dam, 1904 (Huntington Library, Call Number 04-00044).

CONTINUATION SHEET

Property Name: Kaweah No. 1 Diversion

Page 60 of 199



Figure 2. Kaweah No. 1 Diversion Intake, note lack of sandbox, 1904 (Huntington Library, Call Number 04 - 00720).

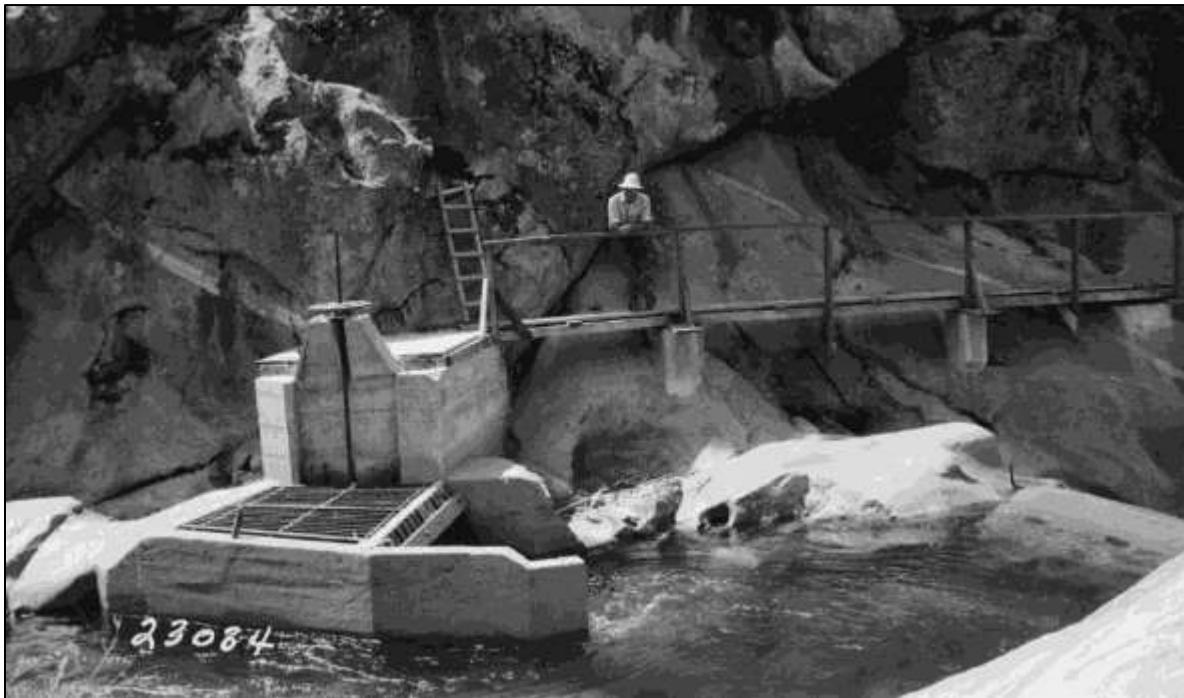

Figure 3. Kaweah No. 1 Diversion Intake, 1940 (Huntington Library, Call Number 02 - 23084).

CONTINUATION SHEET

Property Name: Kaweah No. 1 Diversion

Page 61 of 199



Figure 4. Kaweah No. 1 Diversion Sandbox, 1940 (Huntington Library, Call Number 02 - 23087).

CONTINUATION SHEET

Property Name: Kaweah No. 1 Diversion

Page 62 of 199

Photographs (Continued):



Photograph 2. Kaweah No. 1 Diversion Dam, camera facing northeast. April 18, 2018.



Photograph 3. Kaweah No. 1 Diversion Tunnel, camera facing northeast. April 18, 2018.

CONTINUATION SHEET

Property Name: Kaweah No. 1 Diversion

Page 63 of 199



Photograph 4. Kaweah No. 1 Diversion Sandbox, camera facing northeast. April 18, 2018.



Photograph 5. Kaweah No. 1 Diversion Sandbox showing interior diversion structure, walking platform, and slide gates, camera facing southwest. April 18, 2018.

CONTINUATION SHEET

Property Name: Kaweah No. 1 Diversion

Page 64 of 199



Photograph 6. Former fish passage pipe, camera facing southwest. April 18, 2018.



Photograph 7. West end of sandbox showing trash rack and slide gate, camera facing southwest. April 18, 2018.

CONTINUATION SHEET

Property Name: Kaweah No. 1 Diversion

Page 65 of 199



Photograph 8. Fish wheel and gauge house, camera facing southwest. April 18, 2018.



Photograph 9. Modern concrete spillway with gauge house in distance, camera facing southeast. April 18, 2018.

LOCATION MAP

Property Name: Kaweah No. 1 Diversion

Page 66 of 199

Map Name: Case Mountain, CA

Scale: 1: 24,000

Date of Map: 1987

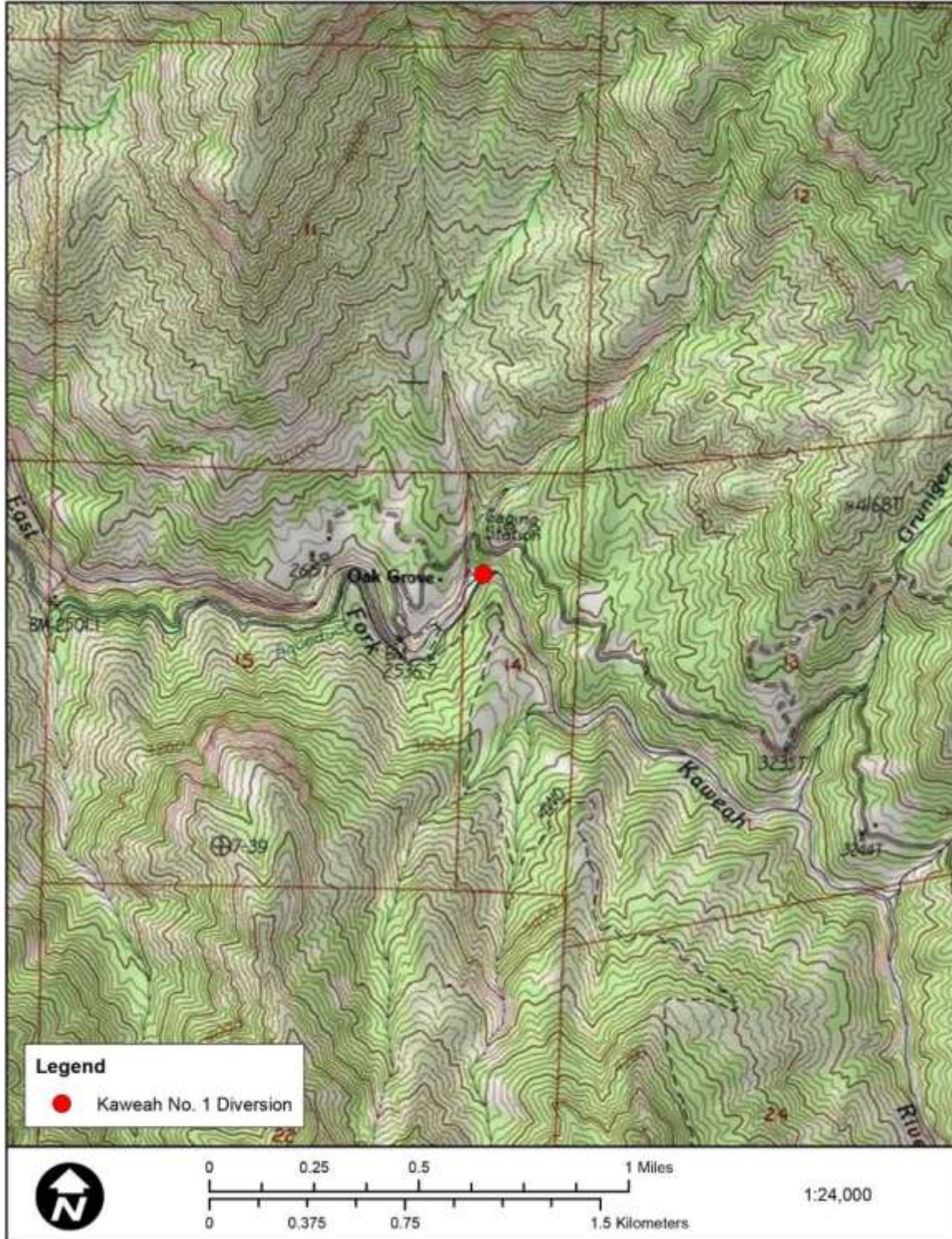

State of California - The Resources Agency
DEPARTMENT OF PARKS AND RECREATION
PRIMARY RECORD

Primary #
HRI #
Trinomial
NRHP Status Code

Other Listings _____
Review Code _____ Reviewer _____ Date _____

Page 67 of 199

*Resource Name or #: (Assigned by recorder) Kaweah No. 1 Flowline

P1. Other Identifier: _____

*P2. Location: Not for Publication Unrestricted *a. County Tulare

and (P2c, P2e, and P2b or P2d. Attach a Location Map as necessary.)

*b. USGS 7.5' Quad Case Mountain, Calif. Date 1987 T 16S R 28E, 29E Sec 9, 14, 15, 38, 39, 40 M.D. B.M.

c. Address City _____ Zip _____

d. UTM: (Give more than one for large and/or linear resources) Zone 11S, 339604.61 mE/ 4035494.25 mN (beginning);

Zone 11S, 333859.41 mE/ 4036557.31 mN (end)

e. Other Locational Data: (e.g., parcel #, directions to resource, elevation, decimal degrees, etc., as appropriate)

Kaweah No. 1 Flowline is accessed using private gated SCE access roads off of Mineral King Road, Three Rivers, CA.

*P3a. Description: (Describe resource and its major elements. Include design, materials, condition, alterations, size, setting, and boundaries)

The Kaweah No. 1 Flowline spans approximately 5.8 miles along steep hillsides, carrying water from the Kaweah No. 1 Diversion on the East Fork of the Kaweah River to the Kaweah No. 1 Forebay for electrical generation at the Kaweah No. 1 Powerhouse (Photograph 1). Upon its completion in 1899, the flowline served as a key component of the initial Kaweah system development and consisted of a redwood box flume supported by a wood structure. In 1947, the original redwood box flume was replaced by a half round metal flume and the support structure was completely reconstructed. As currently constructed, the metal flume is braced by a simple redwood post and beam support structure. The flume is fixed on either side to horizontal beams, supported by dual knee braces. Vertical, cross-braced posts anchored by concrete footings, ranging in height as required by the diverse terrain, elevate the flume structure to allow the flowline to maintain its gradually sloping trajectory (Photographs 2-4) (see Continuation Sheet).

*P3b. Resource Attributes: (List attributes and codes) HP20 - Canal/Aqueduct

*P4. Resources Present: Building Structure Object Site District Element of District Other (Isolates, etc.)

P5a. Photograph or Drawing (Photograph required for buildings, structures, and objects.)



P5b. Description of Photo: (view, date, accession #) Photograph 1 Kaweah No. 1 Flowline, camera facing northeast, April 18, 2018.

*P6. Date Constructed/Age and Source: Historic Prehistoric Both
1899; 1947 (SCE)

*P7. Owner and Address: Southern California Edison
1515 Walnut Grove Avenue
Rosemead, CA 91770

*P8. Recorded by: (Name, affiliation, and address)

Matt Walker and Polly Allen
Cardno, Inc.
2890 Gateway Oaks Dr., Suite 200
Sacramento, CA 95833

*P9. Date Recorded: April 18, 2018

*P10. Survey Type: (Describe) Intensive

*P11. Report Citation: (Cite survey report and other sources, or enter "none.")

CUL-1: Built Environment Technical Study Report, Kaweah Hydroelectric Project, FERC Project No. 298, January 2019

*Attachments: NONE Location Map Continuation Sheet Building, Structure, and Object Record
 Archaeological Record District Record Linear Feature Record Milling Station Record Rock Art Record
 Artifact Record Photograph Record Other (List): _____

BUILDING, STRUCTURE, AND OBJECT RECORD

*Resource Name or # (Assigned by recorder) Kaweah No. 1 Flowline

*NRHP Status Code

Page 68 of 199

- B1. Historic Name: Kaweah No. 1 Flowline
B2. Common Name: Kaweah No. 1 Flowline
B3. Original Use: Water Conveyance B4. Present Use: Water Conveyance

*B5. Architectural Style: Utilitarian

*B6. Construction History: (Construction date, alterations, and date of alterations) Kaweah No. 1 Flowline was constructed in 1899. In 1947, the flowline was entirely reconstructed with the original redwood box flume replaced with a half round metal flume. Since this time, the flowline has been subject to routine maintenance and component replacement as necessary.

*B7. Moved? No Yes Unknown Date: _____ Original Location:

*B8. Related Features: Kaweah Hydroelectric Project (see accompanying records)

B9a. Architect: Mount Whitney Power Company; Southern California Edison Company

b. Builder: Unknown

*B10. Significance: Theme n/a Area n/a
Period of Significance n/a Property Type n/a Applicable Criteria n/a

(Discuss importance in terms of historical or architectural context as defined by theme, period, and geographic scope. Also address integrity.)

Kaweah No. 1 Flowline does not appear to meet the criteria for listing in the National Register of Historic Places (NRHP) or the California Register of Historical Resources (CRHR) as an individual property or as a contributor to any NRHP or CRHR Historic District. Because Kaweah No. 1 Flowline is an operational element of the Kaweah Hydroelectric Project, which includes three operationally related hydroelectric systems, the facility was evaluated for NRHP and CRHR eligibility within the context of the larger operational hydroelectric system. Please see attached District Record for full historic context and evaluation of Kaweah No. 1 Flowline. Please refer to accompanying Continuation Sheets for full description of the facility.

B11. Additional Resource Attributes: (List attributes and codes)

*B12. References: See Footnotes

B13. Remarks:

*B14. Evaluator: Polly Allen and Matt Walker

*Date of Evaluation: December 2018

This space reserved for official comments.



CONTINUATION SHEET

Property Name: Kaweah No. 1 Flowline

Page 69 of 199

P3a. Description (Continued):

A simple board catwalk supported by cross ties is located on top of the flume, allowing access to the length of the flowline. Modern wooden staircases and ramps allow access to the flowline at various locations near the Kaweah No. 1 Diversion (**Photograph 5**). See figures for historical imagery of the facility.



Figure 1. Kaweah No. 1 Flowline during winter storm, ca. 1908 (Huntington Library, Call Number 04 - 00721).



Figure 2. Men walking on Kaweah No. 1 Flowline, note redwood box flume, 1940 (Huntington Library, Call Number 02 - 23070).

CONTINUATION SHEET

Property Name: Kaweah No. 1 Flowline

Page 70 of 199



Figure 3. Kaweah No. 1 Flowline at Kaweah River Bridge following reconstruction, note metal flume, 1948 (Huntington Library, Call Number 02 - 26553).



Figure 4. Kaweah No. 1 Flowline during reconstruction, 1947 (Huntington Library, Call Number 02 - 27830).

CONTINUATION SHEET

Property Name: Kaweah No. 1 Flowline

Page 71 of 199

Photographs (Continued):



Photograph 2. Kaweah No. 1 Flowline, note bracing, camera facing northeast. April 18, 2018.



Photograph 3. Kaweah No. 1 Flowline, note post and beam support structure, camera facing northeast. April 18, 2018.

CONTINUATION SHEET

Property Name: Kaweah No. 1 Flowline

Page 72 of 199



Photograph 4. Kaweah No. 1 Flowline traversing the steep hillside, camera facing east. April 18, 2018.



Photograph 5. Stair access along Kaweah No. 1 Flowline, camera facing northeast. April 18, 2018.

LOCATION MAP

Property Name: Kaweah No. 1 Flowline

Page 73 of 199 Map Name: Case Mountain, CA

Scale: 1:24,000

Date of Map: 1987

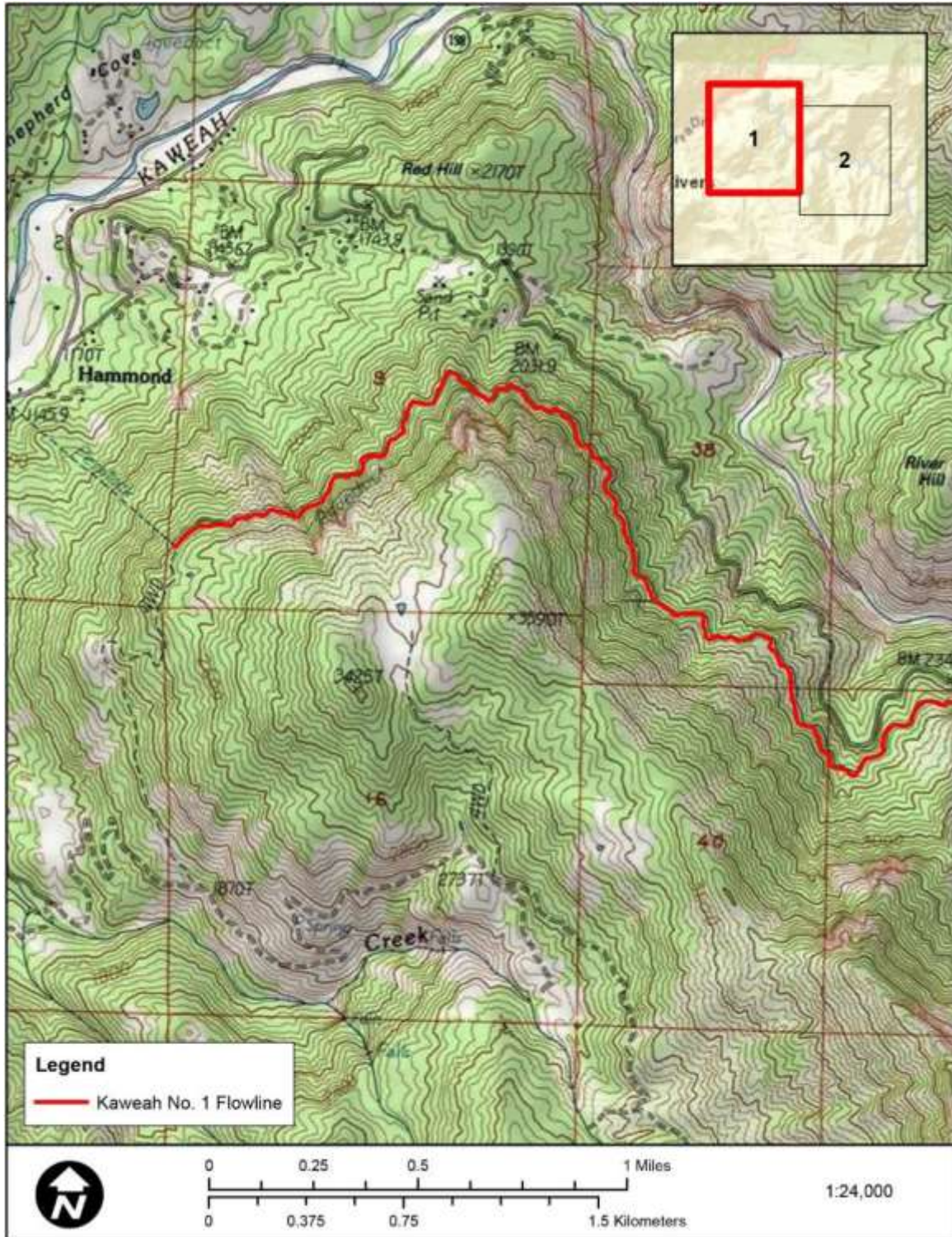

LOCATION MAP

Property Name: Kaweah No. 1 Flowline

Page 74 of 199 Map Name: Case Mountain, CA

Scale: 1:24,000

Date of Map: 1987

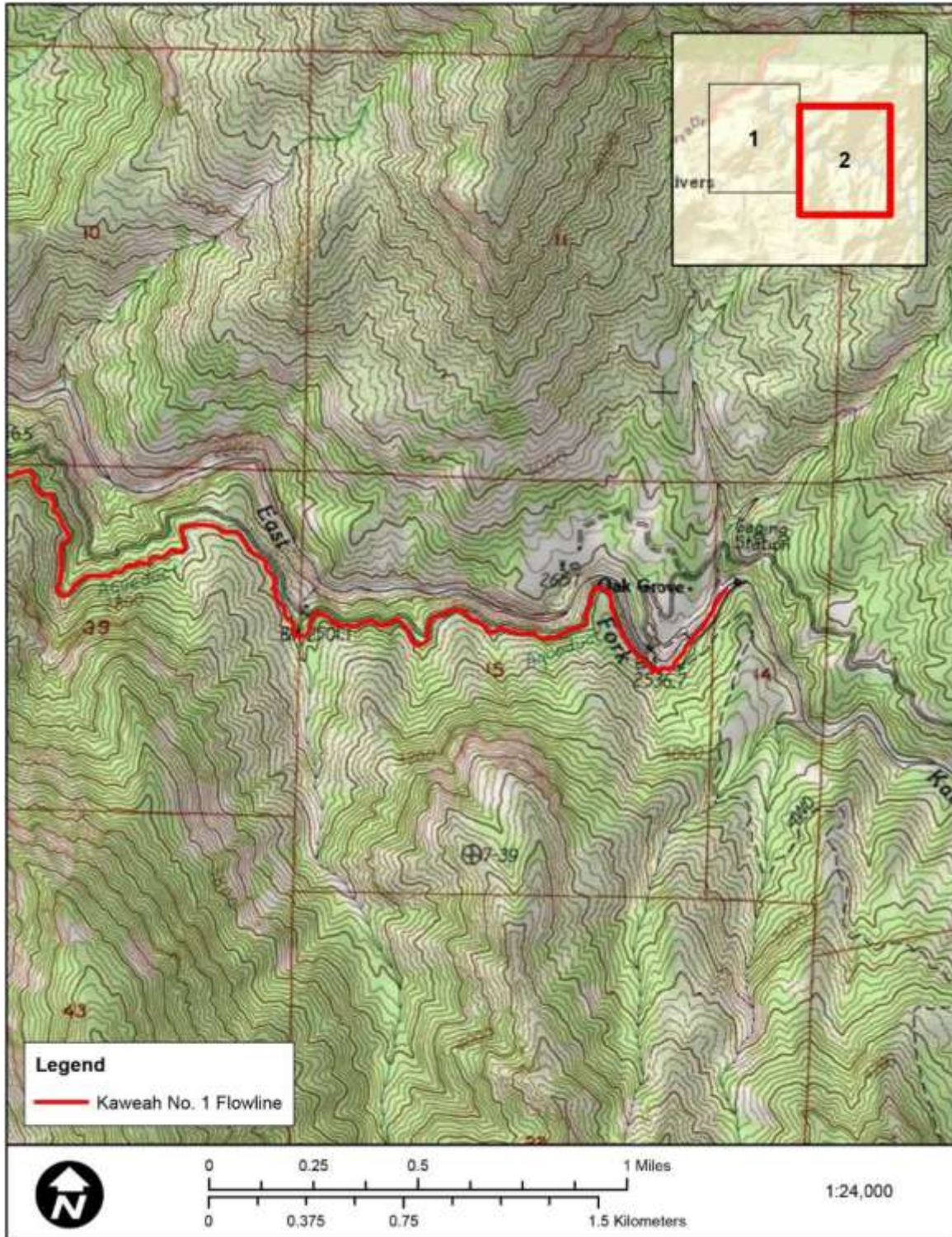

State of California - The Resources Agency
DEPARTMENT OF PARKS AND RECREATION
PRIMARY RECORD

Primary #

HRI #

Trinomial

NRHP Status Code

Other Listings _____
Review Code _____ Reviewer _____ Date _____

Page 75 of 199

*Resource Name or #: (Assigned by recorder) Kaweah No. 1 Forebay

P1. Other Identifier: _____

*P2. Location: Not for Publication Unrestricted *a. County Tulare

and (P2c, P2e, and P2b or P2d. Attach a Location Map as necessary.)

*b. USGS 7.5' Quad Case Mountain, Calif. Date 1987 T 16S; R 28E Sec 9 M.D. B.M.

k. Address _____ City Three Rivers, CA Zip 93271

l. UTM: (Give more than one for large and/or linear resources) Zone 11S, 333855.23 mE/ 4036552.69 mN

m. Other Locational Data: (e.g., parcel #, directions to resource, elevation, decimal degrees, etc., as appropriate)

Kaweah No. 1 Forebay Tank is accessed by SCE's Kaweah No. 1 Forebay Road off of Craig Ranch Road.

*P3a. Description: (Describe resource and its major elements. Include design, materials, condition, alterations, size, setting, and boundaries)

The Kaweah No. 1 Forebay serves as the terminus of the Kaweah No. 1 Flowline and the regulating facility for electrical generation at Kaweah No. 1 Powerhouse. Located on a hillside approximately 0.6 miles east of the powerhouse, the Kaweah No. 1 Forebay consists of a 24-foot diameter steel tank standing 15 feet above ground level with a capacity of 0.18 acre feet (**Photograph 1**). Water enters the forebay tank through an ungated connection with the Kaweah No. 1 Flowline on its east side and exits the tank by passing through a large metal trash rack before entering the Kaweah No. 1 Penstock (**Photographs 2 and 3**). An approximately 100 foot long overflow spillway chute extends from the tank's south side. The chute consists of a trestled half round metal flume with wood bracing (**Photograph 4**). Water from the spillway chute falls into a natural drainage channel and flows downslope into the Kaweah River just south of the powerhouse (see Continuation Sheet).

*P3b. Resource Attributes: (List attributes and codes) HP11 – Engineering structure; HP21 – Dam

*P4. Resources Present: Building Structure Object Site District Element of District Other (Isolates, etc.)

P5a. Photograph or Drawing (Photograph required for buildings, structures, and objects.)



P5b. Description of Photo: (view, date, accession #) Photograph 1 Kaweah No. 1 Forebay, camera facing north, April 18, 2018.

*P6. Date Constructed/Age and Source: Historic Prehistoric Both
1898; 1947 (SCE)

*P7. Owner and Address:
Southern California Edison
1515 Walnut Grove Avenue
Rosemead, CA 91770

*P8. Recorded by: (Name, affiliation, and address)
Matt Walker and Polly Allen
Cardno, Inc.
2890 Gateway Oaks Dr., Suite 200
Sacramento, CA 95833

*P9. Date Recorded: April 18, 2018

*P10. Survey Type: (Describe) Intensive

*P11. Report Citation: (Cite survey report and other sources, or enter "none.")

CUL-1: Built Environment Technical Study Report, Kaweah Hydroelectric Project, FERC Project No. 298, January 2019

*Attachments: NONE Location Map Continuation Sheet Building, Structure, and Object Record
 Archaeological Record District Record Linear Feature Record Milling Station Record Rock Art Record
 Artifact Record Photograph Record Other (List):

State of California - The Resources Agency
 DEPARTMENT OF PARKS AND RECREATION HRI# Primary #
BUILDING, STRUCTURE, AND OBJECT RECORD

*Resource Name or # (Assigned by recorder) Kaweah No. 1 Forebay

*NRHP Status Code

Page 76 of 199

- B1. Historic Name: Kaweah No. 1 Forebay
 B2. Common Name: Kaweah No. 1 Forebay
 B3. Original Use: Regulating Forebay B4. Present Use: Regulating Forebay

*B5. Architectural Style: Utilitarian

*B6. Construction History: (Construction date, alterations, and date of alterations) Original wood forebay tank constructed in 1899 and replaced in 1906 with steel forebay tank. Forebay tank replaced again in 1947 with current steel tank.

*B7. Moved? No Yes Unknown Date: _____ Original Location:

*B8. Related Features: Kaweah Hydroelectric Project (see accompanying records)

B9a. Architect: Mount Whitney Power Company; Southern California Edison Company

b. Builder: Unknown

*B10. Significance: Theme n/a Area n/a
 Period of Significance n/a Property Type n/a Applicable Criteria n/a

(Discuss importance in terms of historical or architectural context as defined by theme, period, and geographic scope. Also address integrity.)

Kaweah No. 1 Forebay does not appear to meet the criteria for listing in the National Register of Historic Places (NRHP) or the California Register of Historical Resources (CRHR) as an individual property or as a contributor to any NRHP or CRHR Historic District. Because Kaweah No. 1 Forebay is an operational element of the Kaweah Hydroelectric Project, which includes three operationally related hydroelectric systems, the facility was evaluated for NRHP and CRHR eligibility within the context of the larger operational hydroelectric system. Please see attached District Record for full historic context and evaluation of Kaweah No. 1 Forebay. Please refer to accompanying Continuation Sheets for full description of the facility.

B11. Additional Resource Attributes: (List attributes and codes)

*B12. References: See Footnotes

B13. Remarks:

*B14. Evaluator: Polly Allen and Matt Walker

*Date of Evaluation: December 2018

This space reserved for official comments.



CONTINUATION SHEET

Property Name: Kaweah No. 1 Forebay

Page 77 of 199

P3a. Description (Continued):

A 16 inch underground steel pipe extends from the base of the forebay tank, providing additional water outlet.

The forebay is accessed using a short wood plank platform leading to a narrow metal catwalk crossing the tank. Tubular metal hand railings provide safety support along the wood platform, catwalk, and the outer edges of the forebay tank. Modern electrical control equipment is affixed to the metal handrails at the north end of the tank, beside the penstock outlet (**Photograph 5**). See figures for historical imagery of the facility.



Figure 1. Original Kaweah No. 1 Forebay, ca. 1908 (Huntington Library, Call Number 04 - 00724).

CONTINUATION SHEET

Property Name: Kaweah No. 1 Forebay

Page 78 of 199



Figure 2. Kaweah No. 1 Forebay following replacement, 1948 (Huntington Library, Call Number 02 - 28092).

CONTINUATION SHEET

Property Name: Kaweah No. 1 Forebay

Page 79 of 199

Photographs (Continued):



Photograph 2. Connection of Kaweah No. 1 Flowline with Kaweah No. 1 Forebay, camera facing northeast.
April 18, 2018.

CONTINUATION SHEET

Property Name: Kaweah No. 1 Forebay

Page 80 of 199



Photograph 3. Metal trash rack at penstock connection, camera facing northwest. April 18, 2018.



Photograph 4. Spillway chute, camera facing west. April 18, 2018.

CONTINUATION SHEET

Property Name: Kaweah No. 1 Forebay

Page 81 of 199

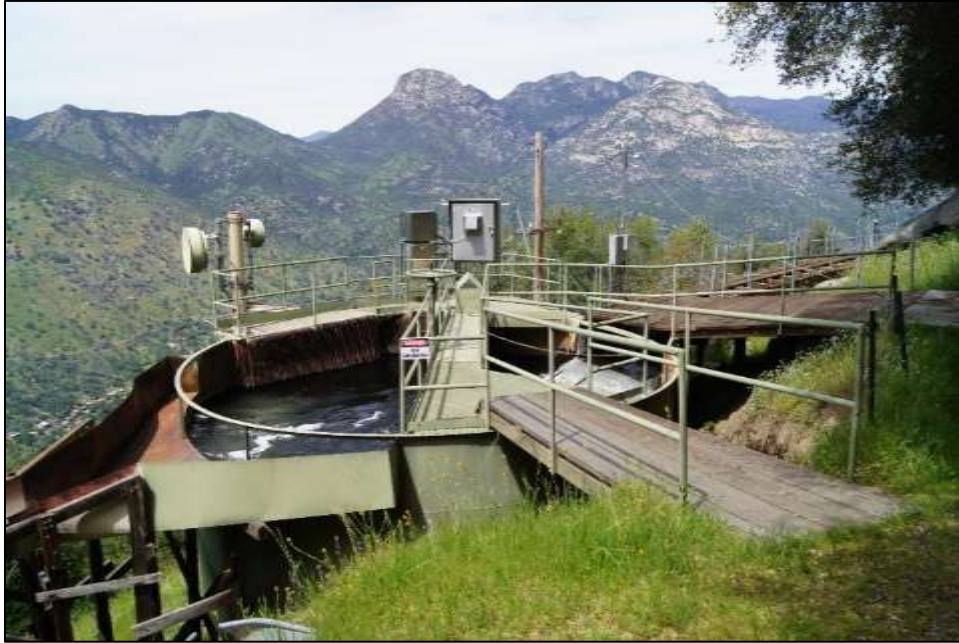

Photograph 5. Kaweah No. 1 Forebay showing wood platform, catwalk, and electrical control equipment, camera facing north. April 18, 2018

LOCATION MAP

Property Name: Kaweah No. 1 Forebay

Page 82 of 199 Map Name: Case Mountain, CA

Scale: 1:24,000

Date of Map: 1987

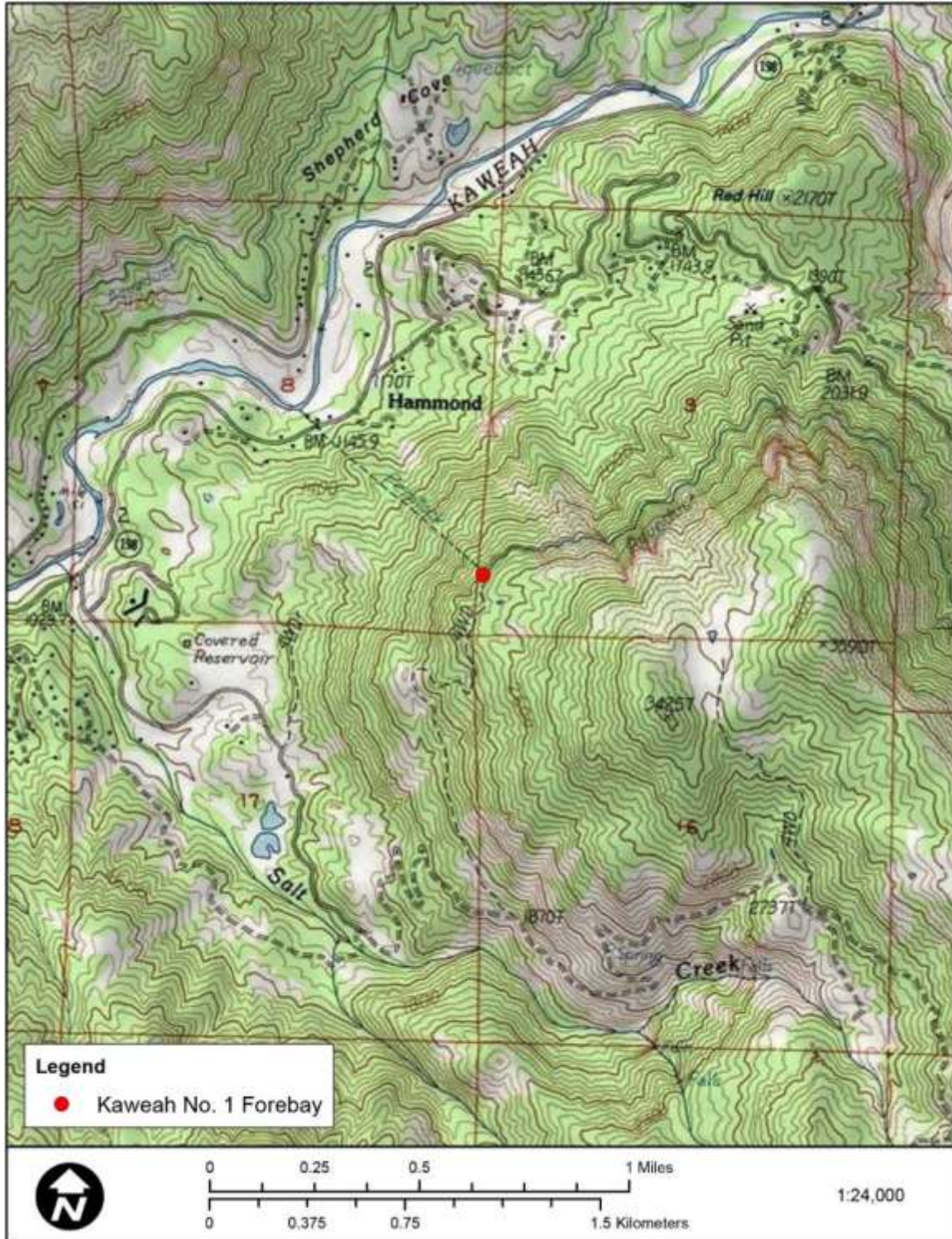

State of California - The Resources Agency
DEPARTMENT OF PARKS AND RECREATION
PRIMARY RECORD

Primary #

HRI #

Trinomial

NRHP Status Code

Other Listings _____

Review Code _____ Reviewer _____ Date _____

Page 83 of 199

*Resource Name or #: (Assigned by recorder) Kaweah No. 1 Powerhouse Campus

P1. Other Identifier: _____

*P2. Location: Not for Publication Unrestricted *a. County Tulare

and (P2c, P2e, and P2b or P2d. Attach a Location Map as necessary.)

*b. USGS 7.5' Quad Case Mountain, Calif. Date 1957 T 16S; R 28E Sec 8 M.D. B.M.

n. Address 44511 Sierra Dr. City Three Rivers, CA Zip 93271

o. UTM: (Give more than one for large and/or linear resources) Zone 11S, 333168.56 mE/ 4037129.50 mN (Kaweah Office)

p. Other Locational Data: (e.g., parcel #, directions to resource, elevation, decimal degrees, etc., as appropriate)

The Kaweah No. 1 Powerhouse Campus is located off of State Route 198 (Sierra Dr.).

*P3a. Description: (Describe resource and its major elements. Include design, materials, condition, alterations, size, setting, and boundaries)

The Kaweah No. 1 Powerhouse Campus is an assemblage of buildings that serve as the administrative and maintenance center for the Kaweah Hydroelectric Project (**Photograph 1**). The campus, located on the north side of State Route 198 in the community of Hammond, Three Rivers, CA, includes several historic-era buildings, including the including the Kaweah Office, Operator's Office, Workshop, Communication House, as well as a large, modern prefabricated Maintenance Building situated at the east end of the campus constructed circa 2011. This DPR 523 form inventories the four historic-era buildings located on the Kaweah No. 1 Powerhouse Campus (See Continuation Sheet).

*P3b. Resource Attributes: (List attributes and codes) HP4 – Ancillary Building

*P4. Resources Present: Building Structure Object Site District Element of District Other (Isolates, etc.)

P5a. Photograph or Drawing (Photograph required for buildings, structures, and objects.)



P5b. Description of Photo: (view, date, accession #) Photograph 1 Kaweah No. 1 Powerhouse Campus Overview, facing north, April 18, 2018.

*P6. Date Constructed/Age and Source: Historic Prehistoric Both 1927; ca. 1950; 2011

*P7. Owner and Address: Southern California Edison
1515 Walnut Grove Avenue
Rosemead, CA 91770

*P8. Recorded by: (Name, affiliation, and address)
Matt Walker and Polly Allen
Cardno, Inc.
2890 Gateway Oaks Dr., Suite 200
Sacramento, CA 95833

*P9. Date Recorded: April 18, 2018

*P10. Survey Type: (Describe) Intensive

*P11. Report Citation: (Cite survey report and other sources, or enter "none.")

CUL-1: Built Environment Technical Study Report, Kaweah Hydroelectric Project, FERC Project No. 298, January 2019

*Attachments: NONE Location Map Continuation Sheet Building, Structure, and Object Record
 Archaeological Record District Record Linear Feature Record Milling Station Record Rock Art Record
 Artifact Record Photograph Record Other (List):

DPR 523A (9/2013)

*Required information

State of California - The Resources Agency
 DEPARTMENT OF PARKS AND RECREATION HRI# Primary #
BUILDING, STRUCTURE, AND OBJECT RECORD

*Resource Name or # (Assigned by recorder) Kaweah No. 1 Powerhouse Campus

*NRHP Status Code

Page 84 of 199

- B1. Historic Name: Kaweah No. 1 Powerhouse Campus
 B2. Common Name: Kaweah No. 1 Powerhouse Campus
 B3. Original Use: Administration and Maintenance Yard B4. Present Use: Administration and Maintenance Yard

*B5. Architectural Style: Utilitarian

*B6. Construction History: (Construction date, alterations, and date of alterations) The Kaweah Office was originally constructed ca. 1950 and expanded in 1990. The Operators Office and Workshop were both built in 1927. The Communication House was built ca. 1950. The K1 Maintenance Building was constructed in 2011.

*B7. Moved? No Yes Unknown Date: _____ Original Location: _____

*B8. Related Features: Kaweah Hydroelectric Project (see accompanying records)

B9a. Architect: Unknown

b. Builder: Unknown

*B10. Significance: Theme n/a Area n/a

Period of Significance n/a Property Type n/a Applicable Criteria n/a (Discuss importance in terms of historical or architectural context as defined by theme, period, and geographic scope. Also address integrity.)

The Kaweah No. 1 Powerhouse Campus does not appear to meet the criteria for listing in the National Register of Historic Places (NRHP) or the California Register of Historical Resources (CRHR) as an individual property or as a contributor to any NRHP or CRHR Historic District. Because the Kaweah No. 1 Powerhouse Campus is an administrative support element of the Kaweah Hydroelectric Project, which includes three operationally related hydroelectric systems, the facility was evaluated for NRHP and CRHR eligibility within the context of the larger operational hydroelectric system. Please see attached District Record for full historic context and evaluation of the Kaweah No.1 Powerhouse Campus. Please refer to accompanying Continuation Sheets for full description of the facility.

B11. Additional Resource Attributes: (List attributes and codes)

*B12. References: See Footnotes

B13. Remarks:

*B14. Evaluator: Polly Allen and Matt Walker

*Date of Evaluation: December 2018

This space reserved for official comments.



CONTINUATION SHEET

Property Name: Kaweah No. 1 Powerhouse Campus

Page 85 of 199

P3a. Description (Continued):

The Kaweah Office (Building 0102) is located along State Route 198 at the south end of the Kaweah No. 1 Powerhouse Campus and serves as the Project's primary administrative building. Originally a small, side gabled building, the building was significantly altered and expanded in 1990. As currently constructed, the Supervisor's Office is a single story building with an irregular low pitch cross hip on gable roof. The concrete block building has a primary side gable portion with a smaller hipped roof addition with a south facing gable end on its west end. The building has a combination of modern metal sash fixed and sliding windows. A short flight of concrete block stairs leads to the building's primary metal entrance door on its north side, with a secondary glazed metal entrance door on its east side (**Photographs 2-3**). One of the first three generators used in the Kaweah No. 1 Powerhouse is stationed just west of the Supervisor's Office, marking the site of the original powerhouse location (**Photograph 4**).

Located just northwest of the office, the Operators Office (Building 0107) is a utilitarian single story, wood frame, side gable building with a rectangular footprint. The buildings is entirely clad in modern corrugated metal and topped by a medium pitch corrugated metal roof. The roof projects slightly from the building's east end, supported by simple braced wood posts, creating an open-air storage space. A corrugated metal shade structure with metal post supports is located adjacent to the buildings west gable end. The building's main entrance is located on its south side and consists of a modern metal door. Three modern vinyl windows are located to the west of the door on the building's south side. A covered breezeway on the north side of the building provides additional storage as well as a secondary entrance consisting of a metal door (**Photographs 5-6**).

The Workshop (Building 0110) is a single story, wood frame, side gable building with an L-shaped footprint, located north of the Machine Shop. The utilitarian building has corrugated metal siding and a medium pitch roof clad with corrugated metal. Three metal doors provide access to the building on its south side, with a large wood vent located between the two easternmost doors. A rectangular addition, roughly half the length of the building, projects from its north side. The addition has a flat corrugated metal roof as well as a set of metal double doors and a single metal bathroom door. An additional metal door is located adjacent to the rectangular addition on the original portion of the building. Fenestration consists of original multi-light wood sash windows on the buildings north and east sides, with two window openings boarded over on the east gable end (**Photographs 7-8**).

The Communication House (Building 0126) is located east of the Kaweah No. 1 Powerhouse Switchyard. The small rectangular metal building has a medium pitch front gable roof clad with corrugated metal and is stationed on a concrete foundation. A single locked metal door is located on its west side. An air conditioning unit protrudes from its south side. A riveted steel communication tower with concrete footings is located just east of the building (**Photograph 9**). The Maintenance Building, a large, modern prefabricated metal garage with a rectangular footprint, was constructed in 2012 and is located east of the Communication House at the east end of the yard (**Photograph 10**).

CONTINUATION SHEET

Property Name: Kaweah No. 1 Powerhouse Campus

Page 86 of 199

Photographs (Continued):



Photograph 2. Kaweah Office, showing north and west sides, camera facing southeast. April 18, 2018.



Photograph 3. Kaweah Office, showing south and east sides, camera facing northwest. April 18, 2018.

CONTINUATION SHEET

Property Name: Kaweah No. 1 Powerhouse Campus

Page 87 of 199



Photograph 4. Original Kaweah No. 1 Powerhouse generator, camera facing southwest. April 18, 2018.



Photograph 5. Operator's Office, showing south and west sides, camera facing northeast. April 18, 2018.

CONTINUATION SHEET

Property Name: Kaweah No. 1 Powerhouse Campus

Page 88 of 199



Photograph 6. North side of Operator's Office, camera facing southeast. April 18, 2018.



Photograph 7. Workshop, showing south and east sides, camera facing northwest. April 18, 2018.

CONTINUATION SHEET

Property Name: Kaweah No. 1 Powerhouse Campus

Page 89 of 199



Photograph 8. Work Shop, camera facing southeast. April 18, 2018.



Photograph 9. Communications House and tower, camera facing northeast. April 18, 2018.

CONTINUATION SHEET

Property Name: Kaweah No. 1 Powerhouse Campus

Page 90 of 199



Photograph 9. Maintenance Building (modern), camera facing east. April 18, 2018.

LOCATION MAP

Property Name: Kaweah No. 1 Powerhouse Campus

Page 91 of 199 Map Name: Case Mountain, CA

Scale: 1: 24,000

Date of Map: 1987

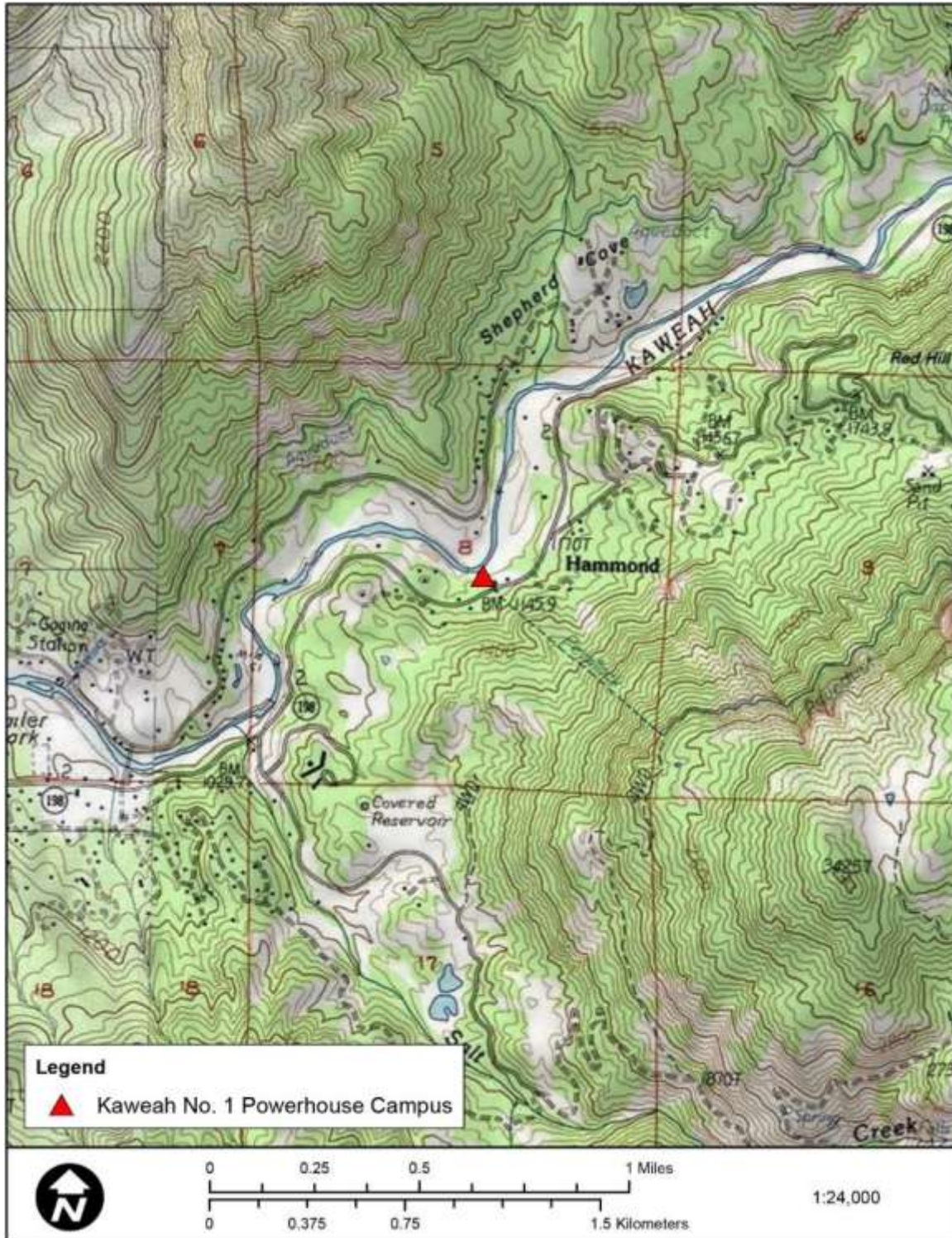

State of California - The Resources Agency
DEPARTMENT OF PARKS AND RECREATION
PRIMARY RECORD

Primary #
HRI #
Trinomial
NRHP Status Code

Other Listings _____
Review Code _____ Reviewer _____ Date _____

Page 92 of 199

*Resource Name or #: (Assigned by recorder) Mineral King Dams

P1. Other Identifier: _____

*P2. Location: Not for Publication Unrestricted *a. County Tulare

and (P2c, P2e, and P2b or P2d. Attach a Location Map as necessary.)

*b. USGS 7.5' Quad Mineral King, Calif. Date 1987 T 17S; R 31E Sec 13, 25, 28 ; M.D. B.M.

q. Address _____ City _____ Zip _____

r. UTM: (Give more than one for large and/or linear resources) Zone 11S, 331565.85 mE/ 4036793.24 mN

s. Other Locational Data: (e.g., parcel #, directions to resource, elevation, decimal degrees, etc., as appropriate)

See Location Map and UTM on Continuation Sheet

*P3a. Description: (Describe resource and its major elements. Include design, materials, condition, alterations, size, setting, and boundaries)

The Kaweah No. 1 Project is supported by four small high elevation reservoirs, collectively known as Mineral King Lakes, which regulate flows into small tributaries of the East Fork of the Kaweah River. Built environment features associated with the reservoirs include four small concrete masonry dams: Eagle Lake Dam, Lady Franklin Dam, Upper Monarch Lake Dam, and Crystal Lake Dam (see Continuation Sheet)

*P3b. Resource Attributes: (List attributes and codes) HP11 – Engineering structure

*P4. Resources Present: Building Structure Object Site District Element of District Other (Isolates, etc.)

P5b. Description of Photo: (view, date, accession #) Photograph 1 Lady Franklin Dam, SCE, 2018.

P5a. Photograph or Drawing (Photograph required for buildings, structures, and objects.)



*P6. Date Constructed/Age and Source:

Historic Prehistoric Both
1903-1905 (SCE)

*P7. Owner and Address:

Southern California Edison
1515 Walnut Grove Avenue
Rosemead, CA 91770

*P8. Recorded by: (Name, affiliation, and address)

Matt Walker and Polly Allen
Cardno, Inc.
2890 Gateway Oaks Dr., Suite 200
Sacramento, CA 95833

*P9. Date Recorded: April 19, 2018

*P10. Survey Type: (Describe) Intensive

*P11. Report Citation: (Cite survey report and other sources, or enter "none.")

CUL-1: Built Environment Technical Study Report, Kaweah Hydroelectric Project, FERC Project No. 298, January 2019

*Attachments: NONE Location Map Continuation Sheet Building, Structure, and Object Record

Archaeological Record District Record Linear Feature Record Milling Station Record Rock Art Record

Artifact Record Photograph Record Other (List)

State of California - The Resources Agency
DEPARTMENT OF PARKS AND RECREATION HRI# Primary #
BUILDING, STRUCTURE, AND OBJECT RECORD

*Resource Name or # (Assigned by recorder) Mineral King Dams *NRHP Status Code

Page 93 of 199

B1. Historic Name: Mineral King Dams
B2. Common Name: Mineral King Dams
B3. Original Use: Tributary dam B4. Present Use: Tributary dam

*B5. Architectural Style: Utilitarian

*B6. Construction History: (Construction date, alterations, and date of alterations) Crystal Lake Dam constructed 1903; Eagle Lake Dam constructed 1904; Lady Franklin Dam constructed 1905; Upper Monarch Dam constructed 1905. All dam's mortar repaired and cement added to dam face on an ongoing basis to the present.

*B7. Moved? No Yes Unknown Date: _____ Original Location:

*B8. Related Features: Kaweah Hydroelectric Project (see accompanying records)

B9a. Architect: Mount Whitney Power Company

b. Builder: Unknown

*B10. Significance: Theme n/a Area n/a
Period of Significance n/a Property Type n/a Applicable Criteria n/a

(Discuss importance in terms of historical or architectural context as defined by theme, period, and geographic scope. Also address integrity.)

The Mineral King Dams do not appear to meet the criteria for listing in the National Register of Historic Places (NRHP) or the California Register of Historical Resources (CRHR) as an individual property or as a contributor to any NRHP or CRHR Historic District. Because the dams are an operational element of the Kaweah Hydroelectric Project, which includes three operationally related hydroelectric systems, the facilities were evaluated for NRHP and CRHR eligibility within the context of the larger operational hydroelectric system. Please see attached District Record for full historic context and evaluation of the Mineral King Dams. Please refer to accompanying Continuation Sheets for full description of the facility.

B11. Additional Resource Attributes: (List attributes and codes)

See Location Map

*B12. References: See footnotes

B13. Remarks:

*B14. Evaluator: Polly Allen and Matt Walker

*Date of Evaluation: December 2018

This space reserved for official comments.

CONTINUATION SHEET

Other Listings _____
 Review Code _____ Reviewer _____ Date _____

P1. Other Identifier: _____

P2. Location

Name	UTM Coordinate
Lady Franklin Dam	11S, 360013.53 m E, 4031767.02 m N
Eagle Lake Dam	11S, 356104.62 m E, 4031443.47 m N
Upper Monarch Lake Dam	11S, 359885.49 m E, 4035195.95 m N
Crystal Lake Dam	11S, 359806.47 m E, 4034103.85 m N

P3a. Description

Lady Franklin Dam is 393 feet in length, 20 feet in height, and 4 feet in width, and is composed of stone set in cement mortar, with a concrete face and rockfill on the downstream side (**Photograph 1**). The dam holds 467 acre feet at maximum capacity and is controlled by a single manually operated gate valve. The dam was originally constructed in 1905, with mortar repaired and cement added to the face on an ongoing basis to the present.

Eagle Lake Dam is 286 feet in length, 15 feet in height, and 5 feet in width, and is composed of stone set in cement mortar, with a concrete face (**Photograph 2**). The dam holds 209 acre feet at maximum capacity. The dam was originally constructed in 1904, with mortar repaired and cement added to the face on an ongoing basis to the present.

Upper Monarch Lake Dam is 263 feet in length and 22.5 feet high and of buttressed stone masonry construction (**Photograph 3**). Loose rockfill is placed between the buttresses on the downstream face and a mortar cap covering the upstream face. Flow is controlled by a manually operated gate valve and the dam has an uncontrolled spillway, located on the right side of the structure. The dam impounds a maximum capacity of 314 acre feet. The dam was originally constructed in 1905, with mortar repaired, cement added to the face, and rockfill added on an ongoing basis to the present.

Crystal Lake Dam is 93 feet in length and 18 feet in height, with a width of 2 feet. The dam is composed of stone set in cement mortar, with a concrete face (**Photograph 4**). The dam holds 162 acre feet at maximum capacity and is controlled by a single manually operated gate valve. The dam was originally constructed in 1903, with mortar repaired and cement added to the face on an ongoing basis to the present.

CONTINUATION SHEET

Primary #
HRI #

Trinomial
NRHP Status Code

Other Listings _____
Review Code _____ Reviewer _____ Date _____

Page 95 of 199

*Resource Name or #: (Assigned by recorder) Mineral King Dams

P1. Other Identifier: _____

Photographs (Continued):



Photograph 2. Eagle Lake Dam. SCE, 2018.



Photograph 3. Upper Monarch Lake Dam. SCE, 2018.

CONTINUATION SHEET

Primary #
HRI #

Trinomial
NRHP Status Code

Other Listings _____
Review Code _____ Reviewer _____ Date _____

P1. Other Identifier: _____



Photograph 4. Crystal Lake. SCE, 2018.

LOCATION MAP

Property Name: Mineral King Dams

Page 97 of 199 Map Name: Mineral King, CA

Scale: 1: 24,000

Date of Map: 1987

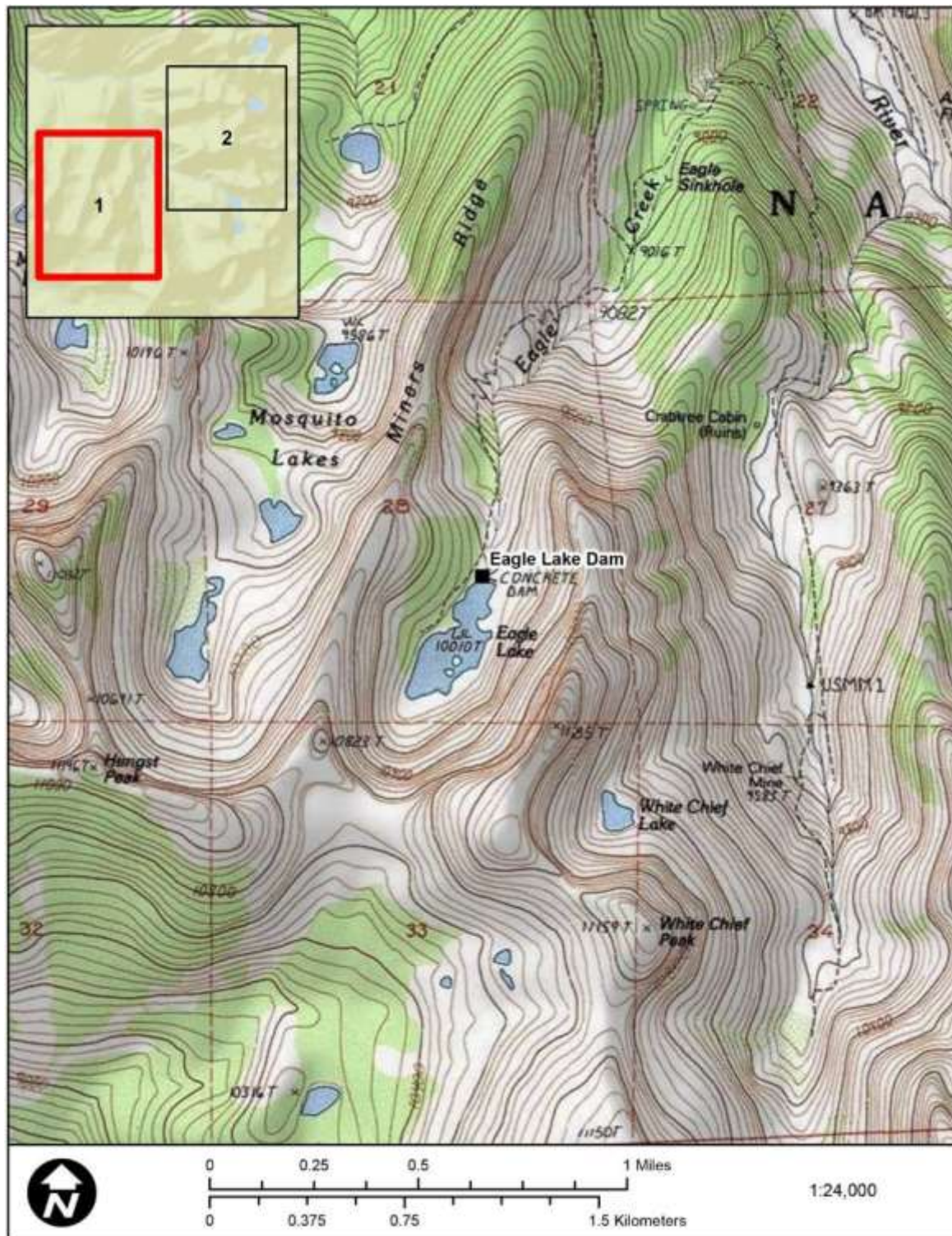

LOCATION MAP

Property Name: Mineral King Dams

Page 98 of 199 Map Name: Mineral King, CA

Scale: 1: 24,000

Date of Map: 1987

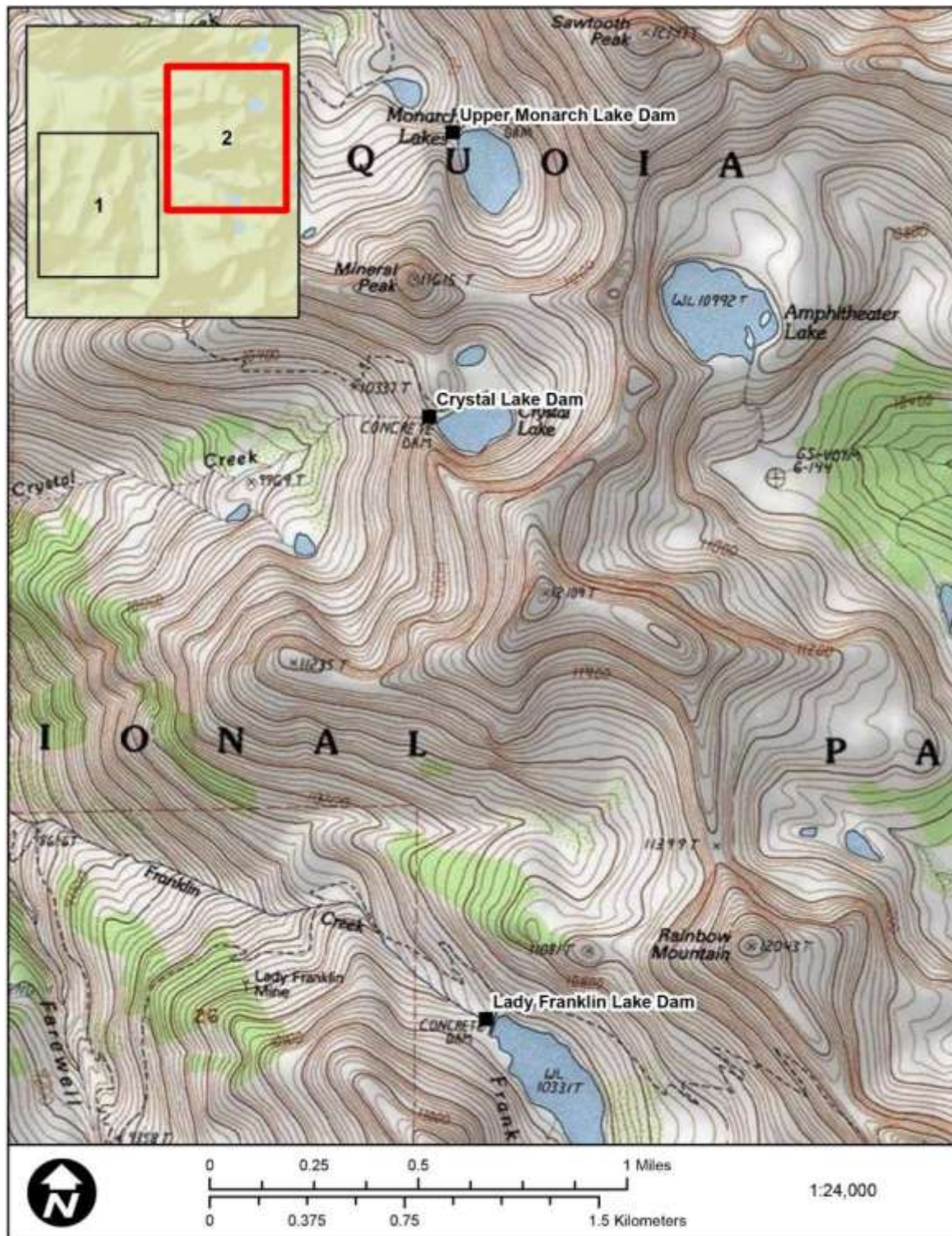

State of California - The Resources Agency
DEPARTMENT OF PARKS AND RECREATION
PRIMARY RECORD

Primary #
HRI #
Trinomial
NRHP Status Code

Other Listings _____
Review Code _____ Reviewer _____ Date _____

Page 99 of 199

*Resource Name or #: (Assigned by recorder) Kaweah No. 2 Powerhouse

P1. Other Identifier: _____

*P2. Location: Not for Publication Unrestricted *a. County Tulare

and (P2c, P2e, and P2b or P2d. Attach a Location Map as necessary.)

*b. USGS 7.5' Quad Kaweah, Calif. Date 1986 T 24N; R 6E Sec 7 ; M.D. B.M.

t. Address _____ City Three Rivers, CA Zip 93271

u. UTM: (Give more than one for large and/or linear resources) Zone 11S, 331565.85 mE/ 4036793.24 mN

v. Other Locational Data: (e.g., parcel #, directions to resource, elevation, decimal degrees, etc., as appropriate)

Kaweah No. 2 Powerhouse is located along Kaweah River Drive, approximately 0.25 mile west of its intersection with Dinely Drive.

*P3a. Description: (Describe resource and its major elements. Include design, materials, condition, alterations, size, setting, and boundaries)

Kaweah No. 2 Powerhouse is a modest two story utilitarian building located just above the north bank of the Kaweah River, approximately one mile downstream of Kaweah No. 1 Powerhouse (**Photograph 1**). This form inventories the Kaweah No. 2 Powerhouse as well as its associated penstock and transmission yard. The simple, rectangular wood-frame building measures approximately 34 feet wide by 62 feet long and roughly 50 feet tall at its peak (**Photograph 2**). The powerhouse is topped with a low pitch front gable roof characterized by its moderate overhang with exposed wood rafter tails, a monitor along its peak running the length of the building, and its corrugated metal cladding. The building's exterior is clad entirely with modern corrugated metal (see Continuation Sheet).

*P3b. Resource Attributes: (List attributes and codes) HP11 – Engineering structure

*P4. Resources Present: Building Structure Object Site District Element of District Other (Isolates, etc.)

*P5b. Description of Photo: (view, date, accession #) Photograph 1 Kaweah No. 2 Powerhouse, camera facing northwest, 4/19/2018.

*P6. Date Constructed/Age and Source: Historic Prehistoric Both 1905 (SCE)

*P7. Owner and Address: Southern California Edison
1515 Walnut Grove Avenue
Rosemead, CA 91770

*P8. Recorded by: (Name, affiliation, and address)

Matt Walker and Polly Allen
Cardno, Inc.
2890 Gateway Oaks Dr., Suite 200
Sacramento, CA 95833

P5a. Photograph or Drawing (Photograph required for buildings, structures, and objects.)



*P9. Date Recorded: April 19, 2018

*P10. Survey Type: (Describe) Intensive

*P11. Report Citation: (Cite survey report and other sources, or enter "none.")

CUL-1: Built Environment Technical Study Report, Kaweah Hydroelectric Project, FERC Project No. 298, January 2019

*Attachments: NONE Location Map Continuation Sheet Building, Structure, and Object Record
 Archaeological Record District Record Linear Feature Record Milling Station Record Rock Art Record
 Artifact Record Photograph Record Other (List):

DPR 523A (9/2013)

*Required information

State of California - The Resources Agency
 DEPARTMENT OF PARKS AND RECREATION HRI# Primary #
BUILDING, STRUCTURE, AND OBJECT RECORD

*Resource Name or # (Assigned by recorder) Kaweah No. 2 Powerhouse *NRHP Status Code
 Page 100 of 199

B1. Historic Name: Kaweah No. 2 Powerhouse
 B2. Common Name: Kaweah No. 2 Powerhouse
 B3. Original Use: Powerhouse B4. Present Use: Powerhouse

*B5. Architectural Style: Utilitarian

*B6. Construction History: (Construction date, alterations, and date of alterations) Powerhouse constructed in 1905. A chain-link fence was added in front of the powerhouse in 1935. The powerhouse was reconstructed in 1949. The building was resheathed with corrugated metal and original windows replaced at an unknown date, circa 2000s. One window was filled on the north side at an unknown date.

*B7. Moved? No Yes Unknown Date: _____ Original Location: _____

*B8. Related Features: Kaweah Hydroelectric Project (see accompanying records)

B9a. Architect: Mount Whitney Power Company

b. Builder: Unknown

*B10. Significance: Theme n/a Area n/a
 Period of Significance n/a Property Type n/a Applicable Criteria n/a

(Discuss importance in terms of historical or architectural context as defined by theme, period, and geographic scope. Also address integrity.)

Kaweah No. 2 Powerhouse does not appear to meet the criteria for listing in the National Register of Historic Places (NRHP) or the California Register of Historical Resources (CRHR) as an individual property or as a contributor to any NRHP or CRHR Historic District. Because the Kaweah No. 2 Powerhouse is an operational element of the Kaweah Hydroelectric Project, which includes three operationally related hydroelectric systems, the facility was evaluated for NRHP and CRHR eligibility within the context of the larger operational hydroelectric system. Please see attached District Record for full historic context and evaluation of the Kaweah No.2 Powerhouse. Please refer to accompanying Continuation Sheets for full description of the facility.

B11. Additional Resource Attributes: (List attributes and codes)

*B12. References: See footnotes

B13. Remarks:

*B14. Evaluator: Polly Allen and Matt Walker

*Date of Evaluation: December 2018

This space reserved for official comments.



CONTINUATION SHEET

Property Name: Kaweah No. 2 Powerhouse

Page 101 of 199

The building's primary entrance is located on its west side. The building's original large wood double doors have been replaced by a much smaller single metal door, with excess space filled with metal slats. The door is flanked by modern six-over-six double-hung metal sash windows, with matching windows directly above at the second story level (**Photograph 3**). Fenestration on the north wall consists of six identical six-over-six double-hung metal sash windows on the first floor level, with five similar windows on the east end in addition to a rear entrance consisting of a single metal door (**Photograph 4**).

A single story, partial width rectangular overhang extends from the center of the building's south side. The projection has a shed roof clad with corrugated metal. Fenestration on the south side, including the single story extension, consists of identical six-over-six double-hung metal sash windows with a narrow band of multi-light windows on the second story level (**Photograph 5**). The original dry-stacked rock retaining wall supports the hillside beside the powerhouse.

The Kaweah No. 2 Penstock extends 1,012 feet down the steep hillside above the powerhouse from the Kaweah No. 2 Forebay and enters the powerhouse on its north side (**Photograph 6**). The buried steel pipe varies in diameter from 60 to 30 inches. After the penstock enters the powerhouse, water passes through a single Francis-type turbine. An 8-ton hand operated traveling steel crane provides hoisting facilities for equipment within the powerhouse. The facility's control and relay panel is located in the southeast corner of the building (**Photograph 7**). Water exits the powerhouse through a steel pipe just below the penstock entry and is diverted back to the Kaweah River through a 0.3-mile long tailrace canal.

The Kaweah No. 2 Switchyard is located adjacent to the powerhouse on the west side of Kaweah River Drive. The electricity generated in the powerhouse is transferred to the switchyard through underground conduit. The outdoor facility contains support equipment for electrical transfer, including an overhead bus structure, three oil circuit breakers and associated single phase lightning arrester, grounding switches, disconnecting switches, and a single three phase transformer bank. All equipment is stationed on a concrete foundation and the yard is enclosed by an eight foot chain-link fence with barbed wire at its peak (**Photograph 8**). See figures for historical imagery of the facility.

CONTINUATION SHEET

Property Name: Kaweah No. 2 Powerhouse

Page 102 of 199



Figure 1. Kaweah No. 2 Powerhouse nearing completion, 1904 (Huntington Library, Call Number 04 - 00054).



Figure 2. Kaweah No. 2 Powerhouse nearing completion, 1904 (Huntington Library, Call Number 04 - 00069).

CONTINUATION SHEET

Property Name: Kaweah No. 2 Powerhouse

Page 103 of 199



Figure 3. Kaweah No. 2 Powerhouse Penstock entering the powerhouse, 1904 (Huntington Library, Call Number 04 - 00055).

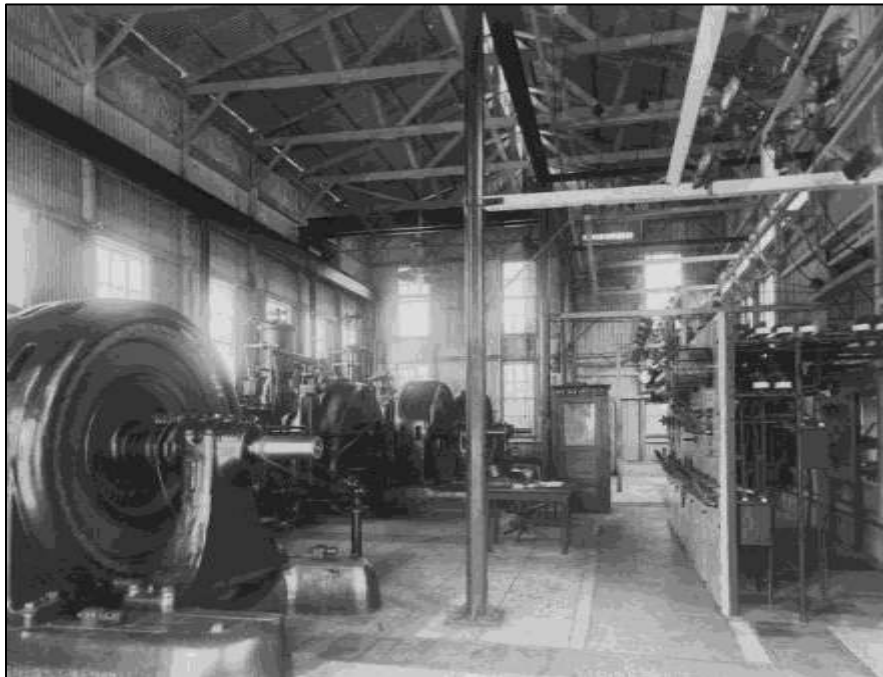

Figure 4. Kaweah No. 2 Powerhouse interior, ca. 1908 (Huntington Library, Call Number 04 - 00735).

CONTINUATION SHEET

Property Name: Kaweah No. 2 Powerhouse

Page 104 of 199

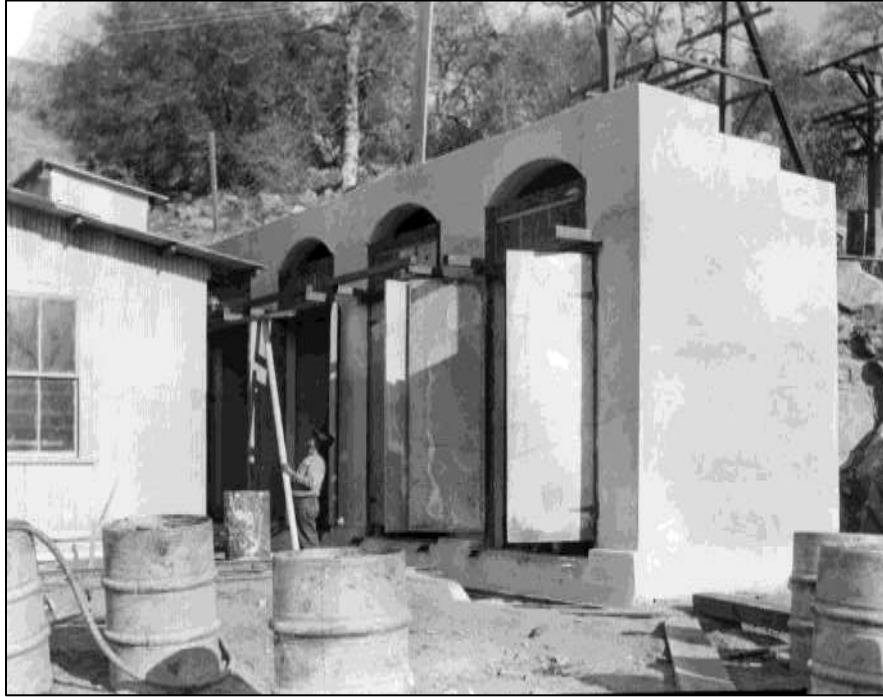

Figure 5. Kaweah No. 2 Powerhouse Transformer Bank, 1904 (Huntington Library, Call Number 04 - 00067).

CONTINUATION SHEET

Property Name: Kaweah No. 2 Powerhouse

Page 105 of 199

Photographs (Continued):



Photograph 2. Kaweah Powerhouse No. 2, camera facing west. April 19, 2018.



Photograph 3. West side of Kaweah Powerhouse No. 2, camera facing northeast. April 19, 2018.

CONTINUATION SHEET

Property Name: Kaweah No. 2 Powerhouse

Page 106 of 199



Photograph 4. Kaweah Powerhouse No. 2, camera facing west. April 19, 2018.



Photograph 5. West side of Kaweah Powerhouse No. 2, camera facing northeast. April 19, 2018.

CONTINUATION SHEET

Property Name: Kaweah No. 2 Powerhouse

Page 107 of 199



Photograph 6. North side of Kaweah Powerhouse No. 2 showing penstock, camera facing northeast. April 19, 2018.



Photograph 7. Interior of Kaweah Powerhouse No. 2, camera facing northwest. April 19, 2018.

CONTINUATION SHEET

Property Name: Kaweah No. 2 Powerhouse

Page 108 of 199



Photograph 8. Kaweah No. 2 Substation, camera facing south. April 19, 2018.

LOCATION MAP

Property Name: Kawah No. 2 Powerhouse

Page 109 of 199

Map Name: Case Mountain, CA

Scale: 1: 24,000

Date of Map: 1987

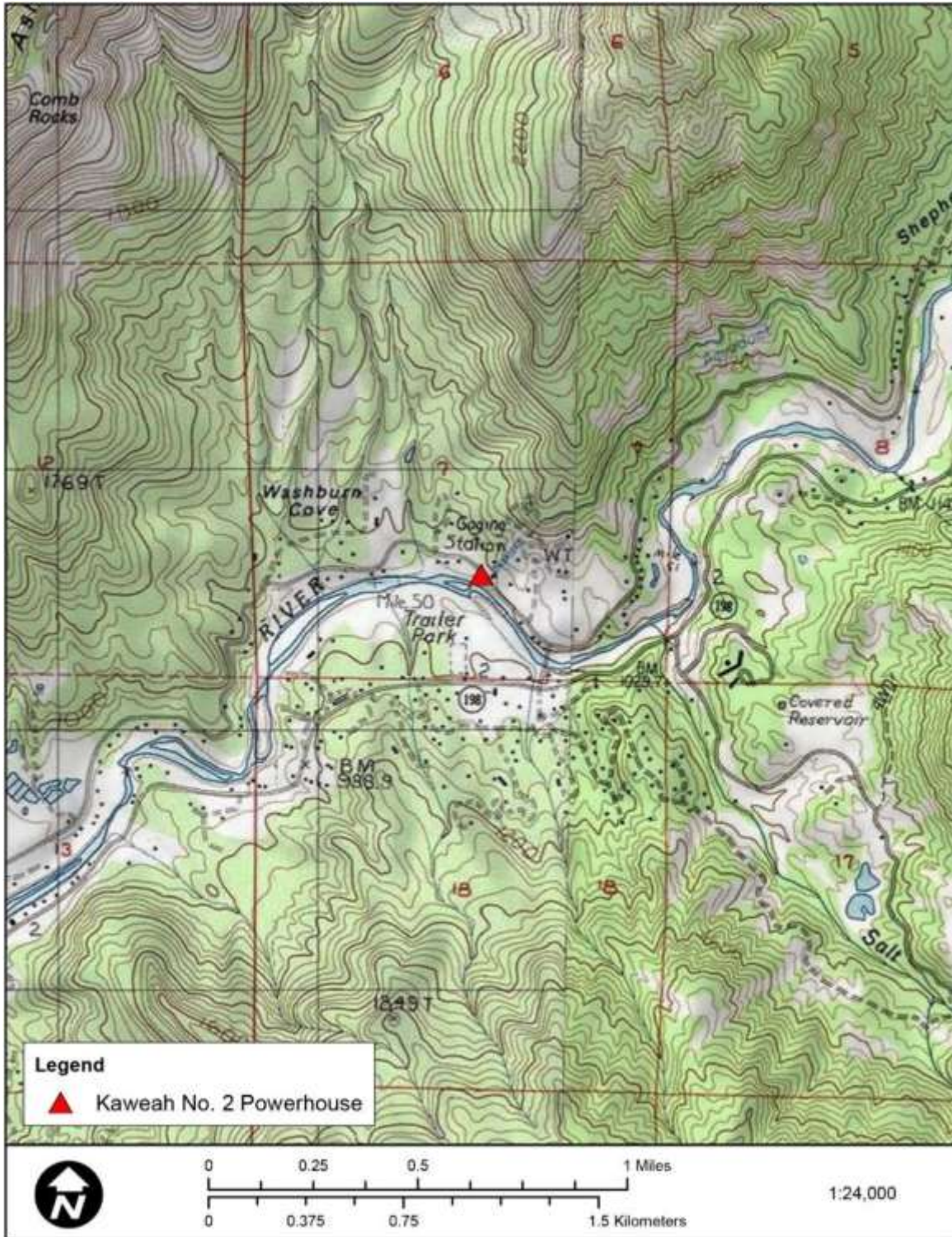

State of California - The Resources Agency
DEPARTMENT OF PARKS AND RECREATION
PRIMARY RECORD

Primary #
HRI #
Trinomial
NRHP Status Code

Other Listings _____
Review Code _____ Reviewer _____ Date _____

Page 110 of 199

*Resource Name or #: (Assigned by recorder) Kaweah No. 2 Diversion

P1. Other Identifier: _____

*P2. Location: Not for Publication Unrestricted *a. County Tulare

and (P2c, P2e, and P2b or P2d. Attach a Location Map as necessary.)

*b. USGS 7.5' Quad Kaweah, Calif. Date 1987 T 16S; R 28E Sec 37 M.D. B.M.

w. Address _____ City Three Rivers, CA Zip 93271

x. UTM: (Give more than one for large and/or linear resources) Zone 11S, 335530.93 mE/ 4039423.54 mN

y. Other Locational Data: (e.g., parcel #, directions to resource, elevation, decimal degrees, etc., as appropriate)

Kaweah No. 2 Diversion is accessed using an unpaved, gated SCE road approximately 300 feet from the Ash Mountain Entrance to Sequoia National Park on State Route 198.

*P3a. Description: (Describe resource and its major elements. Include design, materials, condition, alterations, size, setting, and boundaries)

The Kaweah No. 2 Diversion is located on the Kaweah River, approximately one mile above its junction with the East Fork. This form inventories the Kaweah No. 2 Diversion, including the Kaweah No. 2 Diversion Dam as well as its associated intake structure. Situated at an elevation of 1,365 feet, the Kaweah No. 2 Diversion Dam is a simple, seven-foot tall granite masonry overflow gravity dam with a crest length of 161 feet (**Photograph 1**). The dam was designed to impound between one and two acre feet of water; however, over time, the diversion pool has filled in with sediment and currently holds approximately 0.2 acre-feet (see Continuation Sheet).

*P3b. Resource Attributes: (List attributes and codes) HP11 – Engineering structure; HP21 – Dam

*P4. Resources Present: Building Structure Object Site District Element of District Other (Isolates, etc.)

P5a. Photograph or Drawing (Photograph required for buildings, structures, and objects.)

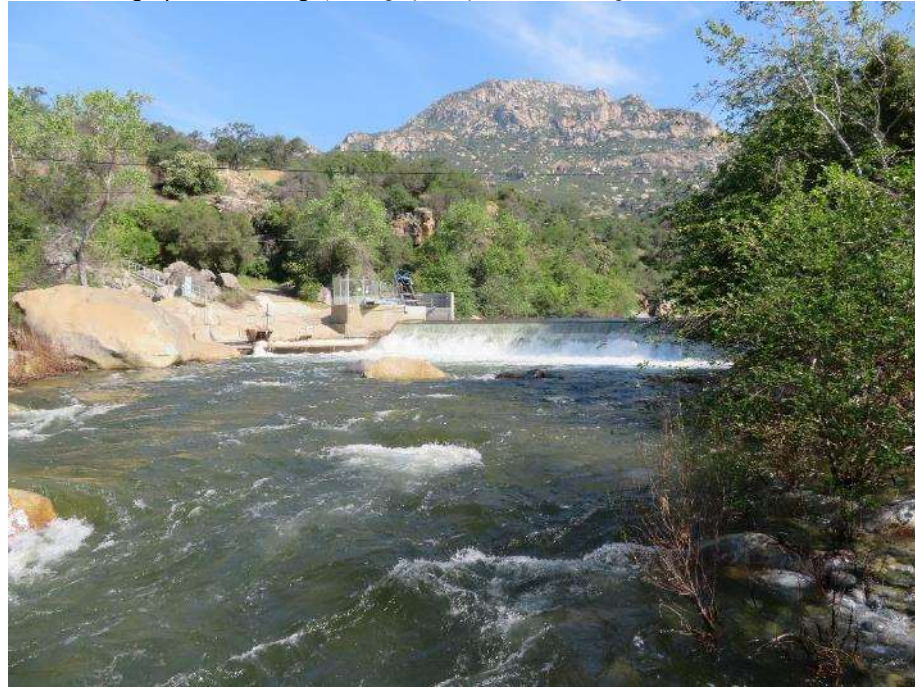

P5b. Description of Photo: (view, date, accession #) Photograph 1 Kaweah No. 2 Diversion, camera facing north, May 8, 2018.

*P6. Date Constructed/Age and Source:
 Historic Prehistoric Both
1905; 1938; 2012-2013 (SCE)

*P7. Owner and Address:
Southern California Edison
1515 Walnut Grove Avenue
Rosemead, CA 91770

*P8. Recorded by: (Name, affiliation, and address)
Matt Walker
Cardno, Inc.
2890 Gateway Oaks Dr., Suite 200
Sacramento, CA 95833

*P9. Date Recorded: May 8, 2018

*P10. Survey Type: (Describe) Intensive

*P11. Report Citation: (Cite survey report and other sources, or enter "none.")

CUL-1: Built Environment Technical Study Report, Kaweah Hydroelectric Project, FERC Project No. 298, January 2019

*Attachments: NONE Location Map Continuation Sheet Building, Structure, and Object Record
 Archaeological Record District Record Linear Feature Record Milling Station Record Rock Art Record
 Artifact Record Photograph Record Other (List):

DPR 523A (9/2013)

*Required information

State of California - The Resources Agency
DEPARTMENT OF PARKS AND RECREATION HRI# Primary #
BUILDING, STRUCTURE, AND OBJECT RECORD

*Resource Name or # (Assigned by recorder) Kaweah No. 2 Diversion

*NRHP Status Code

Page 111 of 199

- B1. Historic Name: Kaweah No. 2 Diversion
B2. Common Name: Kaweah No. 2 Diversion
B3. Original Use: Dam/Intake Structure B4. Present Use: Dam/Intake Structure

*B5. Architectural Style: Utilitarian

*B6. Construction History: (Construction date, alterations, and date of alterations) Kaweah No. 2 Diversion constructed in 1905. In 1938, the intake structure was completely reconstructed. The intake was again reconfigured in 2012-2013.

*B7. Moved? No Yes Unknown Date: _____ Original Location:

*B8. Related Features: Kaweah Hydroelectric Project (see accompanying records)

B9a. Architect: Mount Whitney Power Company; Southern California Edison Company

b. Builder: Unknown

*B10. Significance: Theme n/a Area n/a
Period of Significance n/a Property Type n/a Applicable Criteria n/a

(Discuss importance in terms of historical or architectural context as defined by theme, period, and geographic scope. Also address integrity.)

Kaweah No. 2 Diversion does not appear to meet the criteria for listing in the National Register of Historic Places (NRHP) or the California Register of Historical Resources (CRHR) as an individual property or as a contributor to any NRHP or CRHR Historic District. Because the Kaweah No. 2 Diversion is an operational element of the Kaweah Hydroelectric Project, which includes three operationally related hydroelectric systems, the facility was evaluated for NRHP and CRHR eligibility within the context of the larger operational hydroelectric system. Please see attached District Record for full historic context and evaluation of the Kaweah No.2 Diversion. Please refer to accompanying Continuation Sheets for full description of the facility.

B11. Additional Resource Attributes: (List attributes and codes)

*B12. References: See footnotes

B13. Remarks:

*B14. Evaluator: Polly Allen and Matt Walker

*Date of Evaluation: December 2018

This space reserved for official comments.



CONTINUATION SHEET

Property Name: Kaweah No. 2 Diversion

Page 112 of 199

P3a. Description (Continued):

Impounded water is diverted through a metal trash rack near the upstream dam face and into the large, modern concrete intake structure (**Photograph 2**). Head-gate valves control flow into a 54-inch diameter by 42-foot long underground steel pipe. An automated steel slide gate controls flow into the Kaweah No. 2 Flowline, and is accessed using a concrete flood control wall with a tubular metal guard rail (**Photograph 3**).

A modern concrete block control building is located just upslope from the outlet into the Kaweah No. 2 Flowline. The small, rectangular, single story building has a shed roof with wood fascia board and a single metal entrance door on its east side. Steel conduit runs from the buildings south side, down the slight slope to the various automated facility devices (**Photographs 4 and 5**). See figures for historical imagery of facility.



Figure 1. Kaweah No. 2 Diversion, 1904 (Huntington Library)

CONTINUATION SHEET

Property Name: Kaweah No. 2 Diversion

Page 113 of 199

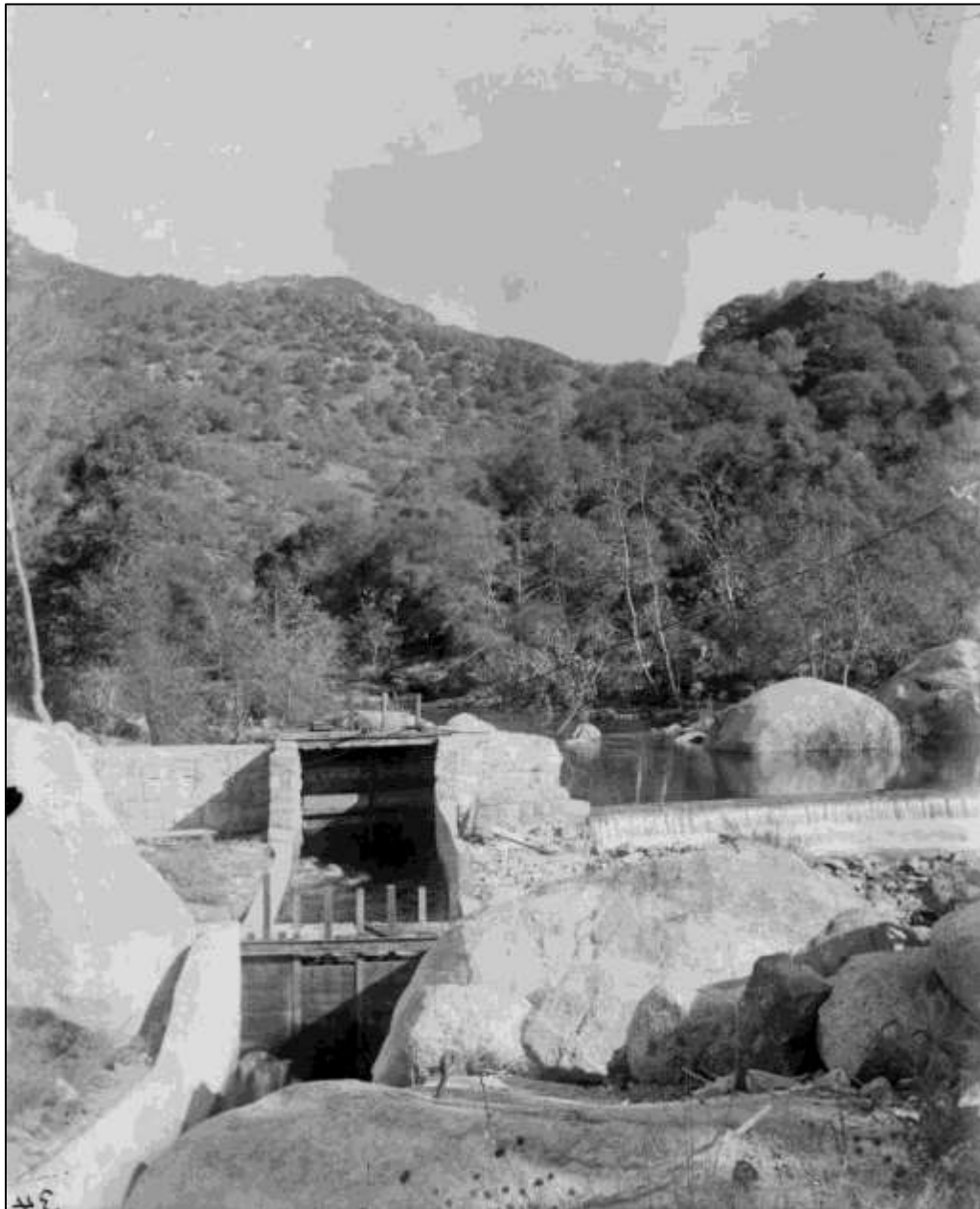

Figure 2. Kaweah No. 2 Diversion intake structure, 1904 (Huntington Library, Call Number 04 - 00034).

CONTINUATION SHEET

Property Name: Kaweah No. 2 Diversion

Page 114 of 199

Photographs (Continued):



Photograph 2. Kaweah No. 2 Diversion intake structure, note metal trash rack, camera facing east. April 18, 2018.



Photograph 3. Diversion Outlet to Kaweah No. 2 Flowline, camera facing south. April 18, 2018.

CONTINUATION SHEET

Property Name: Kaweah No. 2 Diversion

Page 115 of 199



Photograph 4. Control Building. Camera facing north. April 18, 2018.



Photograph 5. Control Building. Camera facing west. April 18, 2018.

LOCATION MAP

Property Name: Kaweah No. 2 Diversion

Page 116 of 199

Map Name: Case Mountain, CA

Scale: 1: 24,000

Date of Map: 1987

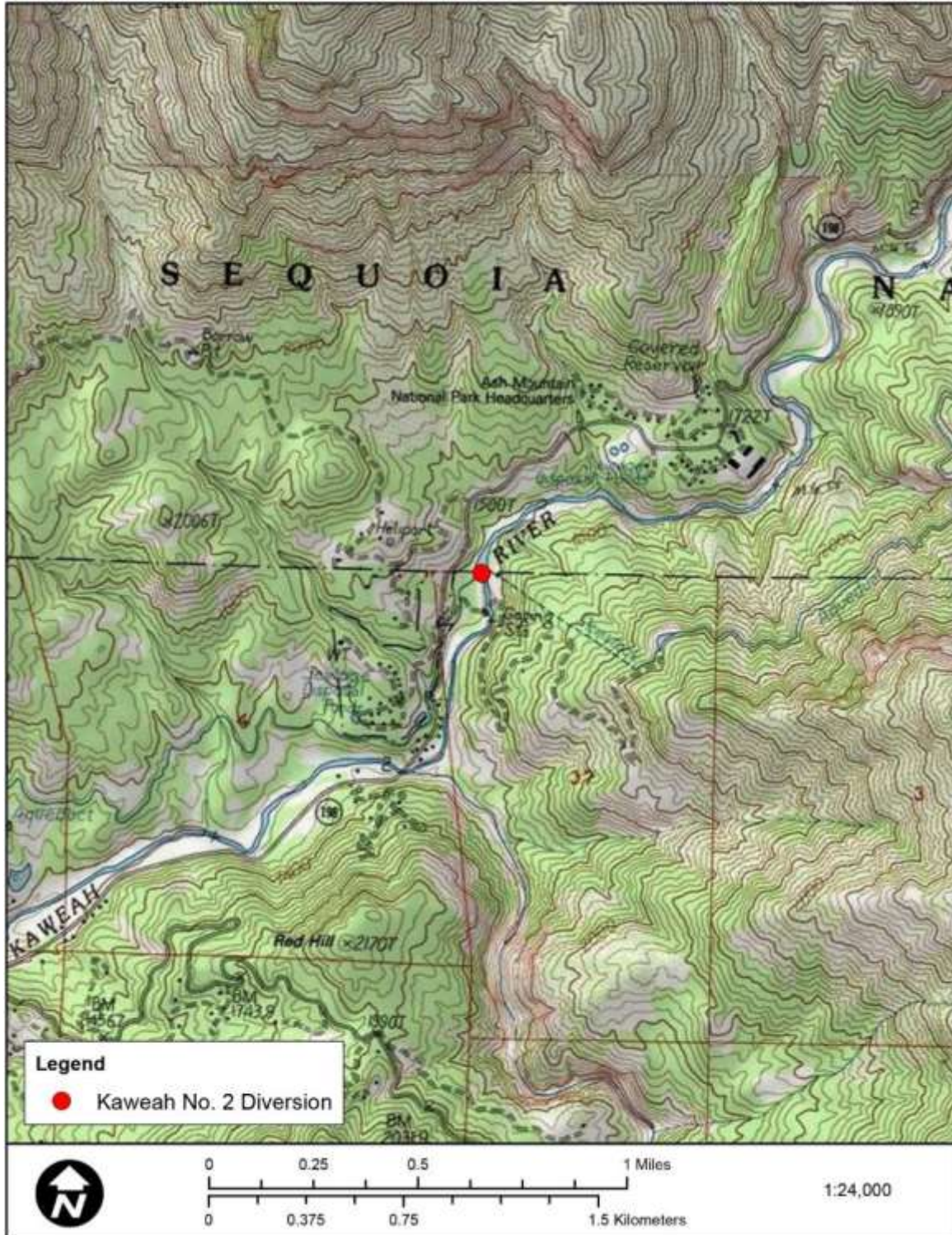

State of California - The Resources Agency
DEPARTMENT OF PARKS AND RECREATION
PRIMARY RECORD

Primary #
HRI #
Trinomial
NRHP Status Code

Other Listings _____
Review Code _____ Reviewer _____ Date _____

Page 117 of 199

*Resource Name or #: (Assigned by recorder) Kaweah No. 2 Flowline

P1. Other Identifier: _____

*P2. Location: Not for Publication Unrestricted *a. County Tulare

and (P2c, P2e, and P2b or P2d. Attach a Location Map as necessary.)

*b. USGS 7.5' Quad Kaweah and Case Mountain; Kaweah, Calif. Date 1987; 1986 T 16S; R 28E Sec 4, 5, 8, 37; 7; M.D. B.M.

z. Address _____ City Three Rivers, CA Zip 93271

aa. UTM: (Give more than one for large and/or linear resources) Zone 11S, 335506.83 mE/ 4039414.80 mN (beginning)
Zone 11S, 331822.06 mE/ 4037032.99 mN (end)

bb. Other Locational Data: (e.g., parcel #, directions to resource, elevation, decimal degrees, etc., as appropriate)

The Kaweah No. 2 Flowline is accessed using several SCE access roads, with the initial segment accessed using a gated access road adjacent to the Ash Mountain Entrance to Sequoia National Park on State Route 198.

*P3a. Description: (Describe resource and its major elements. Include design, materials, condition, alterations, size, setting, and boundaries)

The Kaweah No. 2 Flowline extends approximately 21,607 feet along the gently sloping hillside above the north side of the Kaweah River, carrying water from the Kaweah No. 2 Diversion to the Kaweah No. 2 Forebay. The approximately four mile long flowline consists of 19 segments and 16,738 feet of simple concrete lined ditch, 3,822 feet of steel flume comprised of 19 short segments, and a 1,047 foot long steel siphon pipe (**Photograph 1**). The concrete lined ditch segments are generally slightly wider than the flume spans and rest just below ground level with rounded edges, narrowing at the end as they meet the flume spans. These segments are essentially modern, with concrete poured in the 1980s (**Photograph 2**) (see Continuation Sheet).

*P3b. Resource Attributes: (List attributes and codes) HP20 – Canal/Aqueduct

*P4. Resources Present: Building Structure Object Site District Element of District Other (Isolates, etc.)

P5a. Photograph or Drawing (Photograph required for buildings, structures, and objects.)



*P5b. Description of Photo: (view, date, accession #) Photograph 1 Kaweah No. 2 Flowline, camera facing northwest, May 8, 2018.

*P6. Date Constructed/Age and Source:
 Historic Prehistoric Both
1905; 1948; 1984 (SCE)

*P7. Owner and Address:
Southern California Edison
1515 Walnut Grove Avenue
Rosemead, CA 91770

*P8. Recorded by: (Name, affiliation, and address)
Matt Walker
Cardno, Inc.
2890 Gateway Oaks Dr., Suite 200
Sacramento, CA 95833

*P9. Date Recorded: May 8, 2018

*P10. Survey Type: (Describe) Intensive

*P11. Report Citation: (Cite survey report and other sources, or enter "none.")

CUL-1: Built Environment Technical Study Report, Kaweah Hydroelectric Project, FERC Project No. 298, January 2019

*Attachments: NONE Location Map Continuation Sheet Building, Structure, and Object Record
 Archaeological Record District Record Linear Feature Record Milling Station Record Rock Art Record
 Artifact Record Photograph Record Other (List):

State of California - The Resources Agency
DEPARTMENT OF PARKS AND RECREATION
BUILDING, STRUCTURE, AND OBJECT RECORD

Primary #

HRI#

*Resource Name or # (Assigned by recorder) Kaweah No. 2 Flowline

*NRHP Status Code

Page 118 of 199

- B1. Historic Name: Kaweah No. 2 Flowline
B2. Common Name: Kaweah No. 2 Flowline
B3. Original Use: Water Conveyance B4. Present Use: Water Conveyance

*B5. Architectural Style: Utilitarian

*B6. Construction History: (Construction date, alterations, and date of alterations) Kaweah No. 2 Flowline was completed in 1905. Originally redwood flume segments replaced in 1948 with half round metal flume. Ditch segments relined with concrete in 1984.

*B7. Moved? No Yes Unknown Date: _____ Original Location:

*B8. Related Features: Kaweah Hydroelectric Project (see accompanying records)

B9a. Architect: Mount Whitney Power Company; Southern California Edison Company

b. Builder: Unknown

*B10. Significance: Theme n/a Area n/a

Period of Significance n/a Property Type n/a Applicable Criteria n/a (Discuss importance in terms of historical or architectural context as defined by theme, period, and geographic scope. Also address integrity.)

The Kaweah No. 2 Flowline does not appear to meet the criteria for listing in the National Register of Historic Places (NRHP) or the California Register of Historical Resources (CRHR) as an individual property or as a contributor to any NRHP or CRHR Historic District. Because the Kaweah No. 2 Flowline is an operational element of the Kaweah Hydroelectric Project, which includes three operationally related hydroelectric systems, the facility was evaluated for NRHP and CRHR eligibility within the context of the larger operational hydroelectric system. Please see attached District Record for full historic context and evaluation of the Kaweah No.2 Flowline. Please refer to accompanying Continuation Sheets for full description of the facility.

B11. Additional Resource Attributes: (List attributes and codes)

*B12. References: See footnotes

B13. Remarks:

*B14. Evaluator: Polly Allen and Matt Walker

*Date of Evaluation: December 2018

This space reserved for official comments.



CONTINUATION SHEET

Property Name: Kaweah No. 2 Flowline

Page 119 of 199

P3a. Description (Continued):

Originally redwood box flume, the flume segments were reconstructed using half round metal flume in 1948. The steel flume segments are utilized where the flowline alignment crosses open ravines (**Photograph 3**). The thin, half round metal sheets are braced by metal crossbars every few feet. The original wood support structure have been replaced primarily by modern, riveted steel support structures with concrete footings, with only a few flume segments supported by replacement wood structures remaining. Flume segments are accessed using wood plank catwalks placed directly on top of the steel braces (**Photograph 4 and 5**).

An automatic steel slide gate at the west end of the Kaweah No. 2 Diversion Flow controls flow into the initial narrower, concrete lined ditch segment of the Kaweah No. 2 Flowline (**Photograph 6**). A modern, fenced-in flow control gate and a large, metal fish wheel are located just down flow to help regulate the flow of water into the flowline and prevents unwanted items from passing into the flowline (**Photograph 7**). A small, rectangular board form recorder building is located approximately 150 feet west of the south end of the Kaweah No. 2 Diversion on the south side of the flowline. The building has a shed roof and a replacement metal door is accessed using a simple, modern wood bridge with a tubular metal hand rail crossing the flowline (**Photograph 8**). A 50-inch diameter steel siphon pipe guarded by a large metal trash rack carries flowline water under State Route 198 to a continuation of the first concrete lined ditch segment (**Photograph 9 and 10**). A concrete lined overflow spillway just before the pipeline entrance returns excess water to the Kaweah River. Far down the flowline, at the end of the nineteenth ditch segment, an additional concrete lined spillway controlled by a manually operated slide gate releases water into a natural drainage leading to the Kaweah River (**Photograph 11**). See figures for historical imagery of the facility.



Figure 1. Construction crew cementing Kaweah No. 2 Flowline canal, 1904 (Huntington Library, Call Number 04 - 00038).

CONTINUATION SHEET

Property Name: Kaweah No. 2 Flowline

Page 120 of 199



Figure 2. Kaweah No. 2 Flowline, ca. 1908 (Huntington Library, Call Number 04 - 00732).



Figure 3. Reconstruction of Kaweah No. 2 Flowline, note metal flume and support structure, 1948 (Huntington Library, Call Number 02 - 28477).

CONTINUATION SHEET

Property Name: Kaweah No. 2 Flowline

Page 121 of 199



Figure 4. Replacing Flume 1 with metal siphon, 1948 (Huntington Library, Call Number 02 - 28431).

CONTINUATION SHEET

Property Name: Kaweah No. 2 Flowline

Page 122 of 199

Photographs (Continued):



Photograph 2. Concrete lined ditch segment of Kaweah No. 2 Flowline, camera facing northeast. May 8, 2018.



Photograph 3. Flume span along Kaweah No. 2 Flowline, camera facing northwest. May 8, 2018.

CONTINUATION SHEET

Property Name: Kaweah No. 2 Flowline

Page 123 of 199



Photograph 4. Flume span along Kaweah No. 2 Flowline, note replacement metal support structure, camera facing northwest. May 8, 2018.



Photograph 5. Flume span along Kaweah No. 2 Flowline showing wood support structure, camera facing northwest. May 8, 2018.

CONTINUATION SHEET

Property Name: Kaweah No. 2 Flowline

Page 124 of 199



Photograph 6. Slide gate release to Kaweah No. 2 Flowline, camera facing north. May 8, 2018.



Photograph 7. Water control gate and fish wheel, camera facing southwest. May 8, 2018.

CONTINUATION SHEET

Property Name: Kaweah No. 2 Flowline

Page 125 of 199



Photograph 8. Recorder building along first concrete ditch segment, camera facing northeast. May 8, 2018.



Photograph 9. Spillway and entry trashrack at transition to siphon pipe, camera facing southwest. May 8, 2018.

CONTINUATION SHEET

Property Name: Kaweah No. 2 Flowline

Page 126 of 199



Photograph 10. Siphon pipe, camera facing southwest. May 8, 2018.



Photograph 11. Slide gate and concrete spillway along flowline, camera facing north. May 8, 2018

LOCATION MAP

Property Name: Kaweah No.2 Flowline

Page 127 of 199 Map Name: Kaweah and Case Mountain, CA

Scale: 1: 24,000

Date of Map: 1986, 1987



LOCATION MAP

Property Name: Kaweah No.2 Flowline

Page 128 of 199 Map Name: Kaweah and Case Mountain, CA

Scale: 1:24,000

Date of Map: 1986, 1987

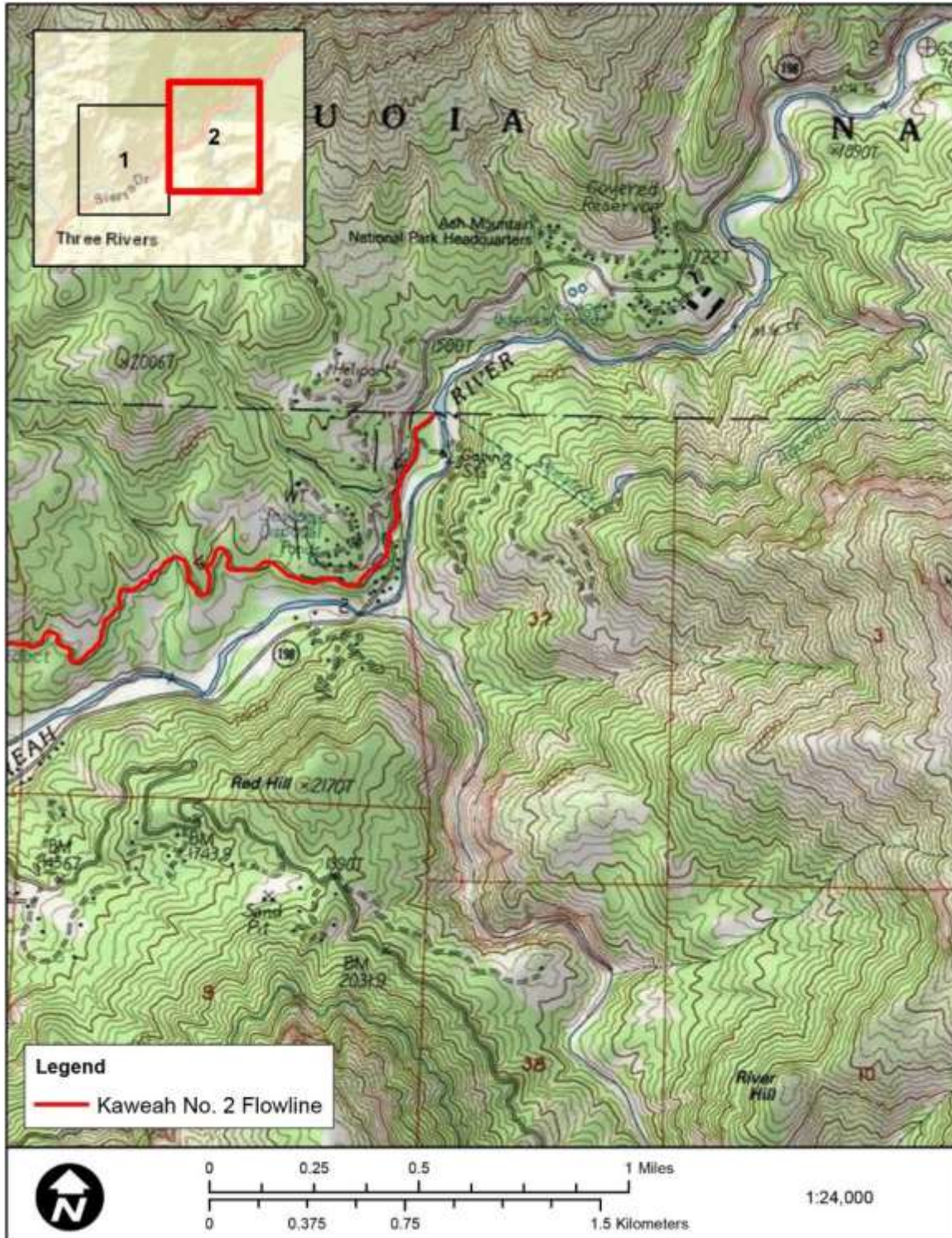

State of California - The Resources Agency
DEPARTMENT OF PARKS AND RECREATION
PRIMARY RECORD

Primary #
HRI #
Trinomial
NRHP Status Code

Other Listings _____
Review Code _____ Reviewer _____ Date _____

Page 129 of 199

*Resource Name or #: (Assigned by recorder) Kaweah No. 2 Forebay

P1. Other Identifier: _____

*P2. Location: Not for Publication Unrestricted *a. County Tulare

and (P2c, P2e, and P2b or P2d. Attach a Location Map as necessary.)

*b. USGS 7.5' Quad Kaweah, Calif. Date 1986 T 16S; R 28E Sec 7; M.D. B.M.

cc. Address _____ City Three Rivers, CA Zip 93271

dd. UTM: (Give more than one for large and/or linear resources) Zone 11S, 331763.62 mE/ 4037009.33 mN

ee. Other Locational Data: (e.g., parcel #, directions to resource, elevation, decimal degrees, etc., as appropriate)

The Kaweah No. 2 Forebay is accessed using SCE's Kaweah No. 2 Forebay Road, a gated dirt road located approximately 0.3 miles north of State Route 198.

*P3a. Description: (Describe resource and its major elements. Include design, materials, condition, alterations, size, setting, and boundaries)

The Kaweah No. 2 Forebay serves as the terminus of the Kaweah No. 2 Flowline and the regulating facility for electrical generation at Kaweah No. 2 Powerhouse. Located on a steep hillside high above the Kaweah No. 2 Powerhouse, the Kaweah No. 2 Forebay consists of a small, concrete reservoir with a holding capacity of 0.75 acre feet (**Photograph 1**). The reservoir, essentially an enlargement of the Kaweah No. 2 Flowline canal, begins at the west end of Flume 15 and measures 180 feet long, 13 feet wide, and 14 feet deep. A large, automated metal trash rack structure helps filter debris from entering the final holding chamber before the penstock, approximately 20 feet from the west end of the reservoir (**Photograph 2**). The forebay is entirely lined with a layer of replacement gunite, covering the original concrete reservoir (see Continuation Sheet).

*P3b. Resource Attributes: (List attributes and codes) HP11 – Engineering structure

*P4. Resources Present: Building Structure Object Site District Element of District Other (Isolates, etc.)

P5a. Photograph or Drawing (Photograph required for buildings, structures, and objects.)

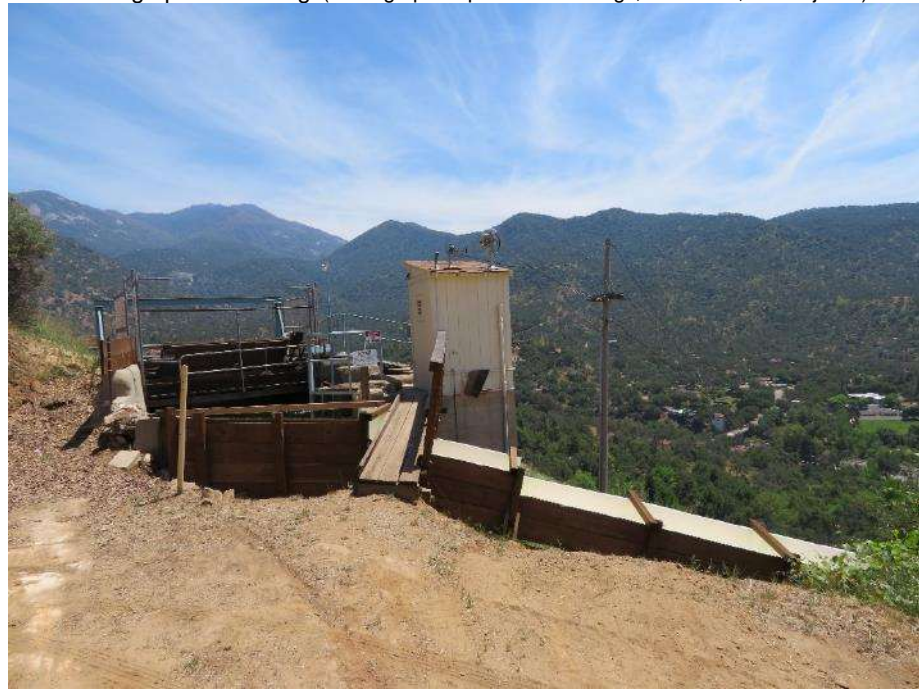

*P5b. Description of Photo: (view, date, accession #) Photograph 1 Kaweah No. 2 Forebay, camera facing east, May 8, 2018.

*P6. Date Constructed/Age and Source:
 Historic Prehistoric Both
1905; 1946 (SCE)

*P7. Owner and Address:
Southern California Edison
1515 Walnut Grove Avenue
Rosemead, CA 91770

*P8. Recorded by: (Name, affiliation, and address)
Matt Walker
Cardno, Inc.
2890 Gateway Oaks Dr., Suite 200
Sacramento, CA 95833

*P9. Date Recorded: May 8, 2018

*P10. Survey Type: (Describe) Intensive

*P11. Report Citation: (Cite survey report and other sources, or enter "none.")

CUL-1: Built Environment Technical Study Report, Kaweah Hydroelectric Project, FERC Project No. 298, January 2019

*Attachments: NONE Location Map Continuation Sheet Building, Structure, and Object Record
 Archaeological Record District Record Linear Feature Record Milling Station Record Rock Art Record
 Artifact Record Photograph Record Other (List):

State of California - The Resources Agency
DEPARTMENT OF PARKS AND RECREATION HRI# Primary #
BUILDING, STRUCTURE, AND OBJECT RECORD

*Resource Name or # (Assigned by recorder) Kaweah No. 2 Forebay

*NRHP Status Code

Page 130 of 199

- B1. Historic Name: Kaweah No. 2 Reservoir
B2. Common Name: Kaweah No. 2 Forebay
B3. Original Use: Forebay B4. Present Use: Forebay

*B5. Architectural Style: Utilitarian

*B6. Construction History: (Construction date, alterations, and date of alterations) The Kaweah No. 2 Forebay was completed in 1905. In 1946, the forebay was lined with a layer of replacement gunite.

*B7. Moved? No Yes Unknown Date: _____ Original Location:

*B8. Related Features: Kaweah Hydroelectric Project (see accompanying records)

B9a. Architect: Mount Whitney Power Company; Southern California Edison Company

b. Builder: Unknown

*B10. Significance: Theme n/a Area n/a
Period of Significance n/a Property Type n/a Applicable Criteria n/a

(Discuss importance in terms of historical or architectural context as defined by theme, period, and geographic scope. Also address integrity.)

The Kaweah No. 2 Forebay does not appear to meet the criteria for listing in the National Register of Historic Places (NRHP) or the California Register of Historical Resources (CRHR) as an individual property or as a contributor to any NRHP or CRHR Historic District. Because the Kaweah No. 2 Forebay is an operational element of the Kaweah Hydroelectric Project, which includes three operationally related hydroelectric systems, the facility was evaluated for NRHP and CRHR eligibility within the context of the larger operational hydroelectric system. Please see attached District Record for full historic context and evaluation of the Kaweah No.2 Forebay. Please refer to accompanying Continuation Sheets for full description of the facility.

B11. Additional Resource Attributes: (List attributes and codes)

*B12. References: See footnotes

B13. Remarks:

*B14. Evaluator: Polly Allen and Matt Walker

*Date of Evaluation: December 2018

This space reserved for official comments.



CONTINUATION SHEET

Property Name: Kaweah No. 2 Forebay

Page 131 of 199

P3a. Description (Continued):

Water exits the forebay by passing through a gated metal trash rack on its south side before flowing down the penstock to the Kaweah No. 2 Powerhouse (**Photograph 3**). An approximately 20 foot long overflow spillway chute extends from the forebay's west end. The chute has a wood frame, metal flume, and wood supports, stationed on concrete footings. Two large metal drainage pipes extend from the base of the forebay and project from the hillside, the eastern pipe having a modern concrete support structure (**Photograph 4**). A second, concrete spillway is located at the east end of the forebay, at the juncture with Flume 15. This concrete spillway has lower walls on its south side and diverts excess water into a concrete chute leading to a natural downhill drainage flowing downhill for discharge into the Kaweah River (**Photograph 5**).

A small control building with horizontal board siding and a shed roof clad with composite shingles is located on an elevated board form concrete foundation at the forebay's southwest corner. The building is entered through a wood door on its east side and has a small metal vent on its north side (**Photograph 6**).

A modern wood platform provides access to the forebay at its west end. Tubular metal hand rails extend along the outer edge of the forebay's west end before a modern, sloped concrete platform leads to a path along the south side of the forebay. Sections of chain-link fence line portions of the forebay's west end. See figures for historical imagery of the facility.



Figure 1. Grading for construction of Kaweah No. 2 Forebay, 1904 (Huntington Library, Call Number 04 - 00013).

CONTINUATION SHEET

Property Name: Kaweah No. 2 Forebay

Page 132 of 199



Figure 2. Kaweah No. 2 Forebay nearing completion, 1904 (Huntington Library, Call Number 04 - 00072).

CONTINUATION SHEET

Property Name: Kaweah No. 2 Forebay

Page 133 of 199

Photographs (Continued):



Photograph 2. Trash rack structure at Kaweah No. 2 Forebay, camera facing west. May 8, 2018.



Photograph 3. Trash rack at entry into Kaweah No. 2 Penstock, camera facing southwest. May 8, 2018.

CONTINUATION SHEET

Property Name: Kaweah No. 2 Forebay

Page 134 of 199



Photograph 4. Modern spillway chute and drainage pipes, camera facing west. May 8, 2018.



Photograph 5. Spillway at east end of forebay, camera facing northwest. May 8, 2018.

CONTINUATION SHEET

Property Name: Kaweah No. 2 Forebay

Page 135 of 199



Photograph 6. Control building and slide gates, camera facing south. May 8, 2018.

LOCATION MAP

Property Name: Kaweah No. 2 Forebay

Page 136 of 199 Map Name: Kaweah, CA

Scale: 1: 24,000

Date of Map: 1986

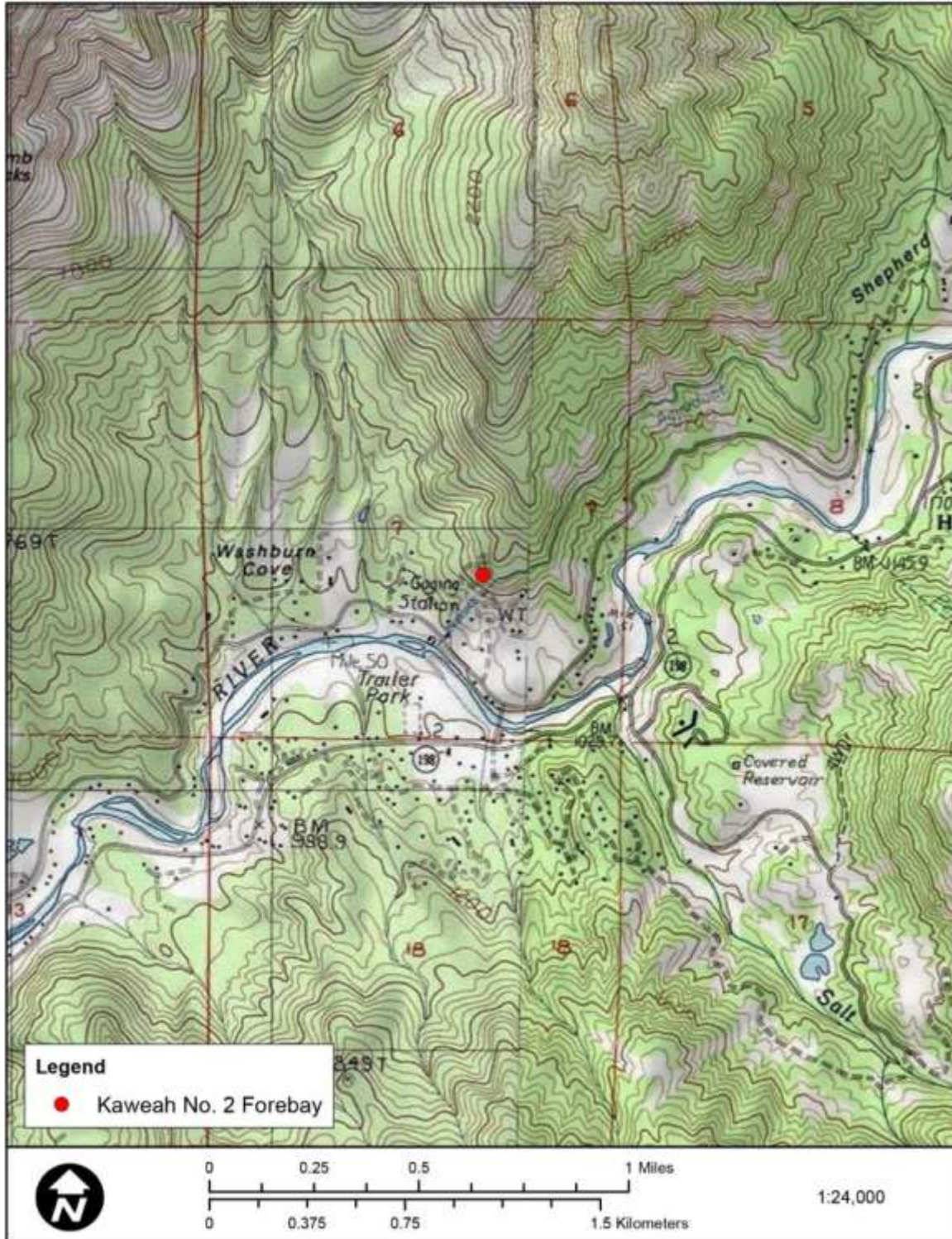

P1. Other Identifier: _____

*P2. Location: Not for Publication Unrestricted *a. County Tulare

and (P2c, P2e, and P2b or P2d. Attach a Location Map as necessary.)

*b. USGS 7.5' Quad Case Mountain, Calif. Date 1987 T 16S; R 28E Sec 37; M.D. B.M.

c. Address City Zip

d. UTM: (Give more than one for large and/or linear resources) Zone 11S, 335589.58 mE/ 4039426.27 mN

e. Other Locational Data: (e.g., parcel #, directions to resource, elevation, decimal degrees, etc., as appropriate)

Kaweah No. 3 Powerhouse is accessed using a gated SCE access road, approximately 300 feet south of the Sequoia National Park Ash Mountain Entrance Station on California State Route 198.

*P3a. Description: (Describe resource and its major elements. Include design, materials, condition, alterations, size, setting, and boundaries)

Kaweah No. 3 Powerhouse is a hydroelectric generating facility located near the east bank of the Kaweah River, approximately two miles upstream from Kaweah Powerhouse No. 1 (**Photograph 1**). This form inventories the Kaweah No. 3 Powerhouse as well as its associated penstock, transmission yard, and garage. The Kaweah No. 3 Powerhouse is a two story, reinforced concrete building with Classical Revival detailing. The powerhouse has a rectangular footprint and measures 51 feet long, 51 feet wide, and stands 35 feet above the ground. The building has a flat concrete roof framed by a simple stepped parapet. Pilasters mark each corner of the building, with two additional pilasters spaced evenly across each wall, which extend to the top of the parapet wall, just above the stepped detailing (**Photograph 2**) (see Continuation Sheet).

*P3b. Resource Attributes: (List attributes and codes) HP11 – Engineering structure

*P4. Resources Present: Building Structure Object Site District Element of District Other (Isolates, etc.)

P5b. Description of Photo: (view, date, accession #) Photograph 1 Kaweah No. 3 Powerhouse, camera facing north, April 18, 2018.

*P6. Date Constructed/Age and Source:
 Historic Prehistoric Both
1913 (SCE)

*P7. Owner and Address:
Southern California Edison
1515 Walnut Grove Avenue
Rosemead, CA 91770

*P8. Recorded by: (Name, affiliation, and address)
Matt Walker and Polly Allen
Cardno, Inc., 2890 Gateway Oaks Dr.,
Suite 200, Sacramento, CA 95833

*P9. Date Recorded: April 18, 2018

*P10. Survey Type: (Describe)
Intensive

P5a. Photograph or Drawing (Photograph required for buildings, structures, and objects.)



*P11. Report Citation: (Cite survey report and other sources, or enter "none.")

CUL-1: Built Environment Technical Study Report, Kaweah Hydroelectric Project, FERC Project No. 298, January 2019

*Attachments: NONE Location Map Continuation Sheet Building, Structure, and Object Record
 Archaeological Record District Record Linear Feature Record Milling Station Record Rock Art Record
 Artifact Record Photograph Record Other (List):

BUILDING, STRUCTURE, AND OBJECT RECORD

*Resource Name or # (Assigned by recorder) _____

*NRHP Status Code _____

Page 138 of 199

- B1. Historic Name: Kaweah No. 3 Powerhouse
B2. Common Name: Kaweah No. 3 Powerhouse
B3. Original Use: Powerhouse B4. Present Use: Powerhouse

*B5. Architectural Style: Classical Revival

*B6. Construction History: (Construction date, alterations, and date of alterations) Kaweah No. 3 Powerhouse and Penstock were completed in 1913. Windows on the first-floor level replaced and roll up metal door and security gates added on main façade at unknown dates. Service garage constructed in 1948.

*B7. Moved? No Yes Unknown Date: _____ Original Location: _____

*B8. Related Features: Kaweah Hydroelectric Project; Kaweah No. 3 Hydroelectric System Historic District (see accompanying records)

B9a. Architect: Mount Whitney Power Company

b. Builder: Unknown

*B10. Significance: Theme Engineering Area Tulare County; California Period of Significance 1913-1916
Property Type Hydroelectric Applicable Criteria A and C

(Discuss importance in terms of historical or architectural context as defined by theme, period, and geographic scope. Also address integrity.)

Kaweah No. 3 Powerhouse appears to meet the criteria for listing in the National Register of Historic Places (NRHP) and the California Register of Historical Resources (CRHR) as a contributor to the Kaweah No. 3 Hydroelectric System Historic District. While the property conveys significance under criteria A and C as part of a significant 1910s hydroelectric system, it does not appear to be individually eligible for listing in the NRHP or CRHR. Rather the significance of the resource is embodied in its functional and physical relationship to the Kaweah No.3 Hydroelectric System as a whole. Please see attached District Record for full evaluation of the facility within the context of the district and Continuation Sheet for physical description and character defining features of this contributing resource.

B11. Additional Resource Attributes: (List attributes and codes)

*B12. References: See Footnotes

B13. Remarks:

*B14. Evaluator: Polly Allen and Matt Walker

*Date of Evaluation: December 2018

This space reserved for official comments.

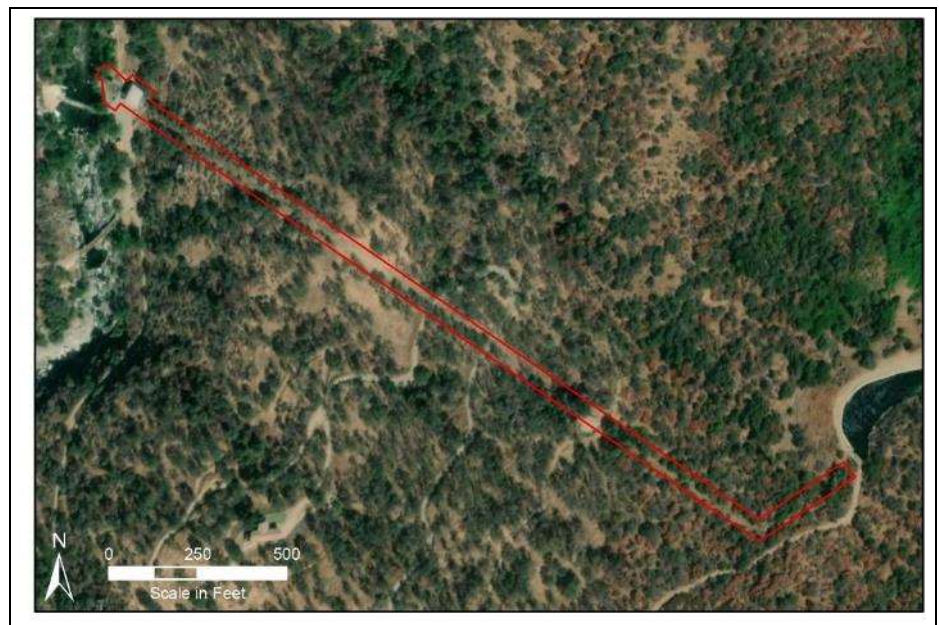

CONTINUATION SHEET

Property Name: Kaweah No. 3 Powerhouse
Page 139 of 199

P3a. Description (Continued):

Bands of metal sash, multi-light industrial windows with central hopper windows are located just below the roofline on each side (**Photograph 3**). A short concrete staircase with a tubular metal hand rail leads to the building's main entrance at the center of its south side. A modern metal security gate protects the building's main metal entrance door, which is flanked by two replacement metal sash windows with an additional multi-light replacement metal sash window near its west end. A modern roll-up metal door with a chain link gate is located near the east end of the building's main façade (**Photograph 2**).

The Kaweah No. 3 Penstock extends 3,151 feet down a steep hillside above the powerhouse from the Kaweah No. 3 Forebay and enters the powerhouse on its east side (**Photograph 4**). The buried steel pipe varies in diameter from 36 to 42 inches. From the forebay, the pipe extends south along a gently sloping ridge. A standpipe projects from the pipe just before the penstock turns west and travels down the steep slope to the powerhouse. Several support structures, including older concrete structures and modern concrete block structures, have been constructed over the years to support the pipe near its entrance into the powerhouse (**Photograph 5**). After the penstock enters the powerhouse, water passes through two single-jet, single-overhung impulse turbines (**Photograph 6**). A 13-ton hand operated traveling steel crane proves hoisting facilities for equipment within the powerhouse. The facility's control and relay panel is located just through the main entrance door, in the southwest corner of the building. Water exits the powerhouse through a short concrete tailrace canal extending from the center of the building's west side and returning the discharged water to the Kaweah River. A modern chain-link metal fence encloses the tailrace canal (**Photograph 7**).

The Kaweah No. 3 Switchyard is located adjacent to the powerhouse, near its west side. The electricity generated in the powerhouse is transferred to the switchyard through conduit extending from the peak of the powerhouse's west side to the switch yard. The outdoor facility contains support equipment for electrical transfer, including an overhead bus structure, one remotely operated oil circuit breaker and associated single phase lightning arrester, grounding switches, disconnecting switches, and a transformer bank consisting of four single phase transformers. One of the four transformers is inactive and serves as a reserve unit (**Photograph 8**).

A single story garage building with a rectangular footprint, Building 0121, is located just southwest of the powerhouse. The wood frame building is topped with a moderately pitched side gable, corrugated metal roof with slight eave overhang and exposed rafter tails. The building is clad with corrugated metal and has a series of sliding wood barn doors on its east side (**Photograph 9**). See figures for historical imagery of the facility.

Character Defining Features of Kaweah No. 3 Powerhouse include:

- The powerhouse location on the south bank of the Kaweah River
- The powerhouse's physical connection to the penstock and supplying water conveyance features
- Its tailrace into the Kaweah River
- The understated industrial Classical Revival styling which includes the building's mass, fenestration, restrained ornamentation, and overall design.
- The overall fenestration and industrial steel-frame windows symmetrically arranged on the building
- Interior scale of the open generator room
- Interior industrial crane
- Casings of original generating equipment and turbines
- The partially buried steel penstock alignment from Kaweah No. 3 Forebay to the Powerhouse

CONTINUATION SHEET

Property Name: Kaweah No. 3 Powerhouse
Page 140 of 199

- Original concrete and laid stone anchor blocks and penstock supports
- The outdoor switchyard has been continuously updated since construction and does not contribute as a character defining feature
- The garage was constructed in the mid-twentieth century and is not operationally integral, and is not a character defining feature
- The Kaweah No. 3 Powerhouse access road and modern (2001) service bridge has been maintained and upgraded since construction and is not a character defining feature
- Safety rails and fences and other appurtenant utility features are not character defining

CONTINUATION SHEET

Property Name: Kaweah No. 3 Powerhouse
Page 141 of 199



Figure 1. Kaweah No. 3 Powerhouse, 1920 (Huntington Library, Call Number 02 - 06179).

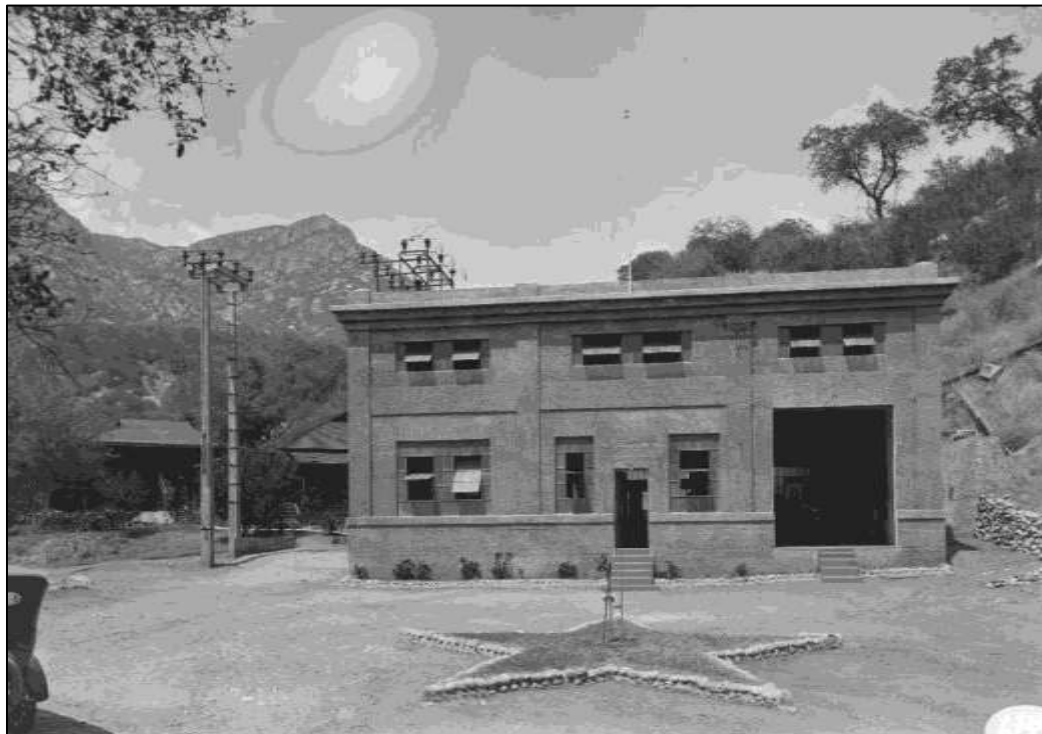

Figure 2. Kaweah No. 3 Powerhouse, 1920 (Huntington Library, Call Number 02 - 06180).

CONTINUATION SHEET

Property Name: Kaweah No. 3 Powerhouse
Page 142 of 199

Photographs (Continued):



Photograph 2. Kaweah No. 3 Powerhouse, note pilasters, fenestration, and roll-up door, camera facing northwest.
April 18, 2018.



Photograph 3. Kaweah No. 3 Powerhouse, note bands of windows, camera facing southeast. April 18, 2018.

CONTINUATION SHEET

Property Name: Kaweah No. 3 Powerhouse

Page 143 of 199

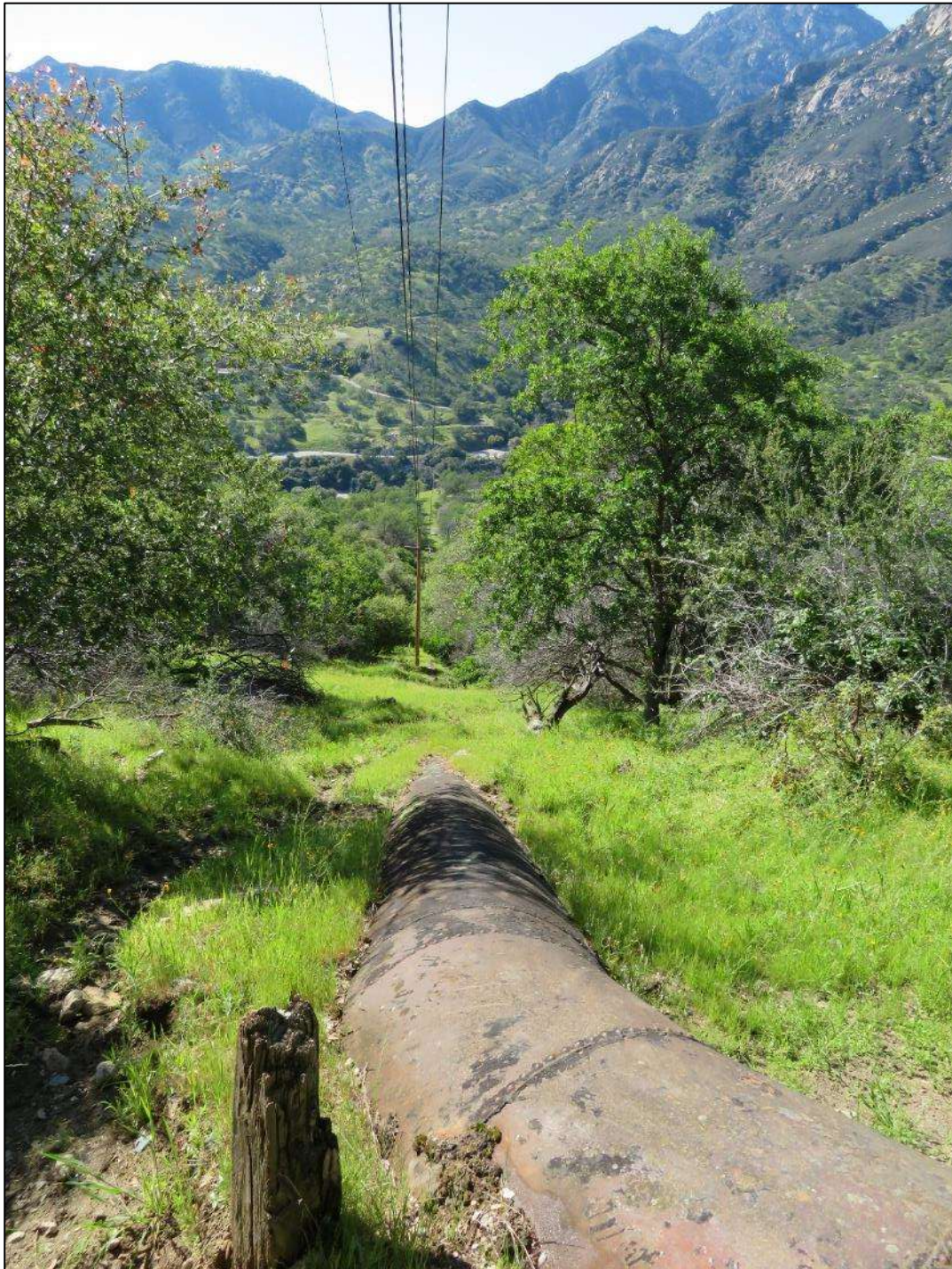

Photograph 4. Kaweah No. 3 Penstock, camera facing west. April 18, 2018.

CONTINUATION SHEET

Property Name: Kaweah No. 3 Powerhouse
Page 144 of 199



Photograph 5. Kaweah No. 3 Penstock, note support structures, camera facing northeast. April 18, 2018.



Photograph 6. Kaweah No. 3 Powerhouse interior, camera facing northwest. April 19, 2018.

CONTINUATION SHEET

Property Name: Kaweah No. 3 Powerhouse
Page 145 of 199



Photograph 7. Tailrace canal extending from Kaweah No. 3 Powerhouse, camera facing northeast. April 18, 2018.



Photograph 8. Kaweah No. 3 Switchyard, note conduit connection, camera facing north. April 18, 2018.

CONTINUATION SHEET

Property Name: Kaweah No. 3 Powerhouse
Page 146 of 199



Photograph 9. Garage southwest of Kaweah No. 3 Powerhouse, camera facing northwest. April 18, 2018.

LOCATION MAP

Property Name: Kaweah No. 3 Powerhouse

Page 147 of 199 Map Name: Case Mountain, CA

Scale: 1: 24,000

Date of Map: 1987

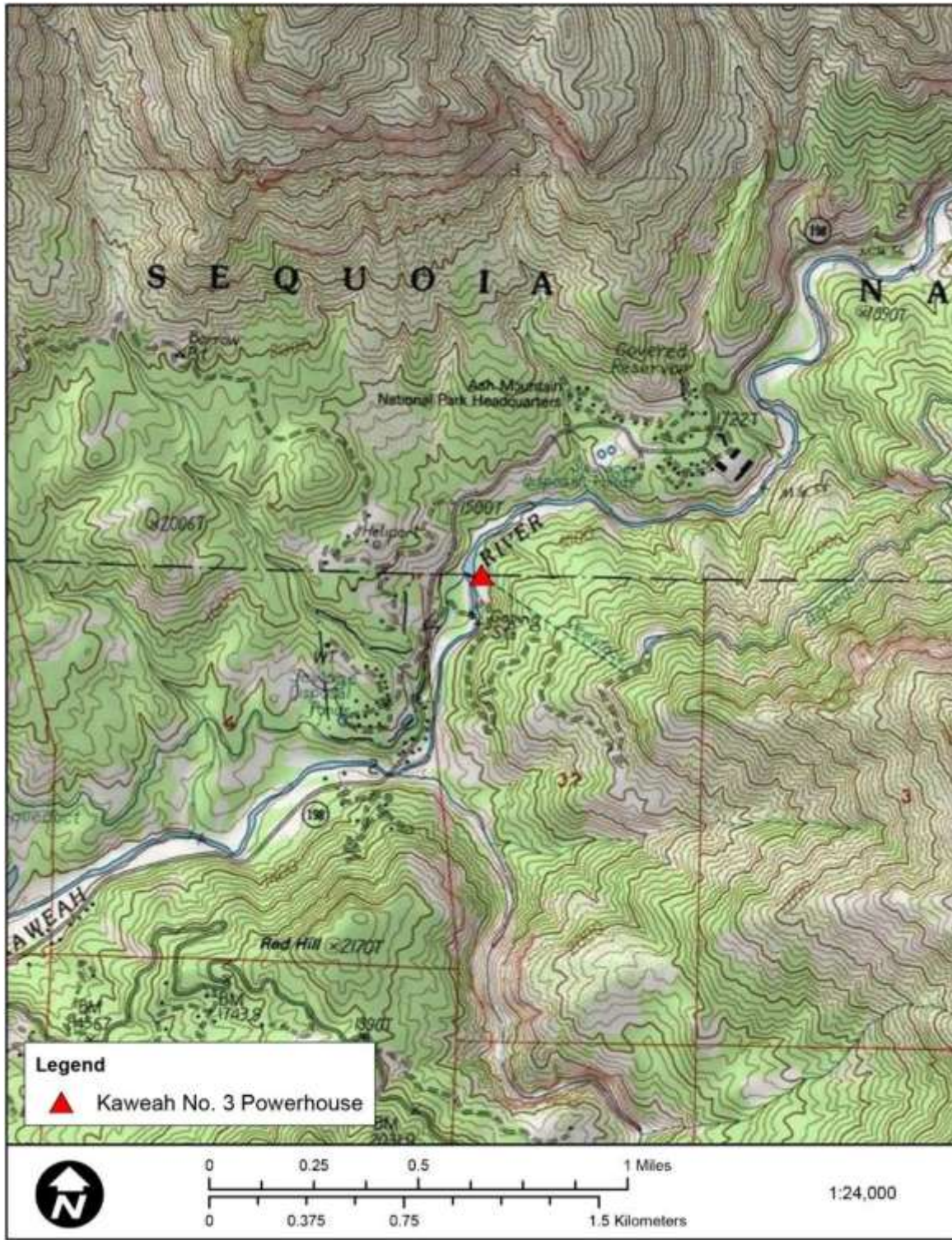

State of California ♦ The Resources Agency
DEPARTMENT OF PARKS AND RECREATION
PRIMARY RECORD

Primary # _____
HRI # _____
Trinomial _____
NRHP Status Code _____
Other Listings _____
Review Code _____ Reviewer _____ Date _____

Page 148 of 199 *Resource Name or #: (Assigned by recorder) Marble Fork Diversion

P1. Other Identifier: _____

*P2. Location: Not for Publication Unrestricted *a. County Tulare
and (P2c, P2e, and P2b or P2d. Attach a Location Map as necessary.)

*b. USGS 7.5' Quad Giant Forest, Calif. Date 1987 T 16S; R 29E Sec 23; M.D. B.M.

c. Address City Zip

d. UTM: (Give more than one for large and/or linear resources) Zone 11S, 338903.47 mE/ 4043363.95 mN

e. Other Locational Data: (e.g., parcel #, directions to resource, elevation, decimal degrees, etc., as appropriate)

The Marble Fork Diversion is accessed by walking a dirt trail approximately 0.25 mile north from Potwisha Campground in Sequoia National Park.

*P3a. Description: (Describe resource and its major elements. Include design, materials, condition, alterations, size, setting, and boundaries)

The Marble Fork Diversion is located in the steep canyon of the Marble Fork Kaweah River, approximately 0.5 mile north of State Route 198. This form inventories the Marble Fork Diversion, including the Marble Fork Diversion Dam as well as its associated intake structure. Situated at an elevation of 2,180 feet, the Marble Fork Diversion Dam is a simple six-foot tall overflow concrete gravity dam with a crest length of approximately 50 feet (**Photographs 1 and 2**). Impounded water flows into an approximately 250-foot-long concrete sandbox, or sediment trap, located on the east side of the Marble Fork (**Photograph 3**). The west wall of the sandbox serves as an ungated overflow spillway, allowing excess water to flow freely back into the river (**Photograph 4**) (see Continuation Sheet).

*P3b. Resource Attributes: (List attributes and codes) HP11 – Engineering structure; HP21 – Dam

*P4. Resources Present: Building Structure Object Site District Element of District Other (Isolates, etc.)

P5a. Photograph or Drawing (Photograph required for buildings, structures, and objects.)



*P5b. Description of Photo: (view, date, accession #) Photograph 1 Marble Fork Diversion, camera facing north, April 17, 2018.

*P6. Date Constructed/Age and Source: Historic Prehistoric Both
1913 (SCE)

*P7. Owner and Address:
Southern California Edison
1515 Walnut Grove Avenue
Rosemead, CA 91770

*P8. Recorded by: (Name, affiliation, and address)
Matt Walker and Polly Allen, Cardno,
Inc., 2890 Gateway Oaks Dr., Suite 200,
Sacramento, CA 95833

*P9. Date Recorded: April 17,
2018

*P10. Survey Type: (Describe)
Intensive

*P11. Report Citation: (Cite survey report and other sources, or enter "none.")

CUL-1: Built Environment Technical Study Report, Kaweah Hydroelectric Project, FERC Project No. 298, January 2019

*Attachments: NONE Location Map Continuation Sheet Building, Structure, and Object Record
 Archaeological Record District Record Linear Feature Record Milling Station Record Rock Art Record
 Artifact Record Photograph Record Other (List):

BUILDING, STRUCTURE, AND OBJECT RECORD

*Resource Name or # (Assigned by recorder) Marble Fork Diversion *NRHP Status Code
Page 149 of 199

B1. Historic Name: Marble Fork Diversion
B2. Common Name: Marble Fork Diversion
B3. Original Use: Dam B4. Present Use: Dam

*B5. Architectural Style: Concrete gravity

*B6. Construction History: (Construction date, alterations, and date of alterations) Marble Fork Diversion was completed in 1913. Since construction, the Marble Fork Diversion has remained largely unaltered, with the exception of regular maintenance and repairs to keep the facility operating efficiently.

*B7. Moved? No Yes Unknown Date: _____ Original Location: _____

*B8. Related Features: Kaweah Hydroelectric Project: Kaweah No. 3 Hydroelectric System Historic District (see accompanying records)

B9a. Architect: Mount Whitney Power Company

b. Builder: Unknown

*B10. Significance: Theme Engineering Area Tulare County; California Period of Significance 1913-1916
Property Type Hydroelectric Applicable Criteria A and C

(Discuss importance in terms of historical or architectural context as defined by theme, period, and geographic scope. Also address integrity.)

Marble Fork Diversion appears to meet the criteria for listing in the National Register of Historic Places (NRHP) and the California Register of Historical Resources (CRHR) as a contributor to the Kaweah No. 3 Hydroelectric System Historic District. While the property conveys significance under criteria A and C as part of a significant 1910s hydroelectric system, it does not appear to be individually eligible for listing in the NRHP or CRHR. Rather the significance of the resource is embodied in its functional and physical relationship to the Kaweah No.3 Hydroelectric System as a whole. Please see attached District Record for full evaluation of the facility within the context of the district and Continuation Sheet for physical description and character defining features of this contributing resource.

B11. Additional Resource Attributes: (List attributes and codes)

*B12. References: See footnotes

B13. Remarks:

*B14. Evaluator: Polly Allen and Matt Walker

*Date of Evaluation: December 2018

This space reserved for official comments.



CONTINUATION SHEET

Property Name: Marble Fork Diversion

Page 150 of 199

P3a. Description (Continued):

A concrete barrier extends the width of the sandbox near its north end, designed to filter out large debris (**Photograph 3**). A tubular metal hand rail on top of the concrete barrier allows access to the base of the sandbox. Three sluice gates along the west side of the structure, one near its north and south ends and one in the center, allow for the release of water through iron pipes near the base of the sandbox. A modern grated steel walkway with tubular metal hand rails provides access to the central sluice gate (**Photograph 5**). Before leaving the sandbox, water passes through a large trash rack structure, with flow into the Marble Fork Flowline controlled by dual manually operated iron slide gates set in a concrete structure (**Photograph 6**). See figures for historical imagery of the facility.

Character Defining Features of the Marble Fork Diversion include:

- The dam's low profile placement and orientation on the Marble Fork Kaweah River
- Concrete diversion structure and sandbox placed on the bank of the river
- The dam's functional relationship to the Mark Fork Flowline and Siphon
- Utilitarian flow regulating gates and trash rack
- Safety rails and fences and other appurtenant utility features are not character defining

CONTINUATION SHEET

Property Name: Marble Fork Diversion
Page 151 of 199



Figure 1. Construction crew at Marble Fork Diversion Dam, ca. 1912 (Huntington Library, Call Number 04 - 00219).

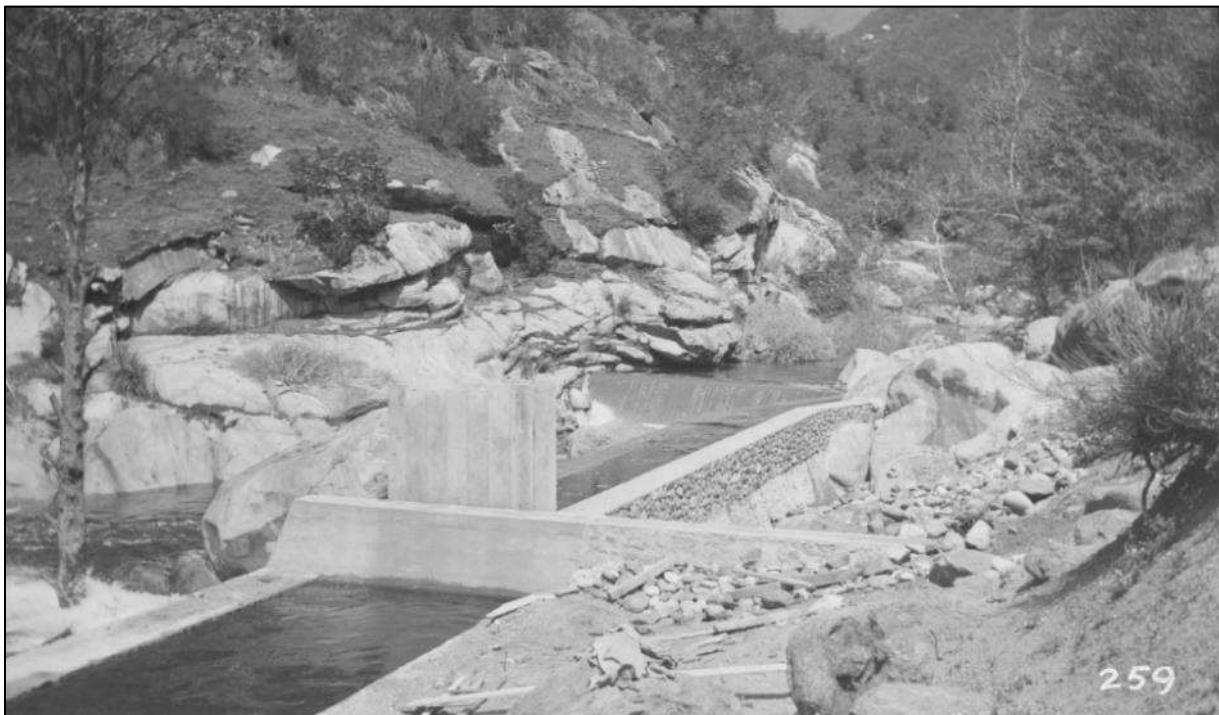

Figure 2. Marble Fork Diversion, undated (Huntington Library, Call Number 04 - 00259).

CONTINUATION SHEET

Property Name: Marble Fork Diversion
Page 152 of 199

Photographs (Continued):



Photograph 2. Marble Fork Diversion Dam and intake, camera facing northeast. April 17, 2018.



Photograph 3. Marble Fork Diversion Sandbox showing concrete barrier, camera facing south. April 17, 2018.

CONTINUATION SHEET

Property Name: Marble Fork Diversion

Page 153 of 199



Photograph 4. Marble Fork Diversion Sandbox showing overflow spillway, camera facing south. April 17, 2018.



Photograph 5. Marble Fork Diversion Sandbox showing grated platform and sluice gate, camera facing south. April 17, 2018.

CONTINUATION SHEET

Property Name: Marble Fork Diversion

Page 154 of 199



Photograph 6. Trash rack and slide gates at Marble Fork Diversion, camera facing southwest. April 17, 2018.

LOCATION MAP

Property Name: Marble Fork Diversion

Page 155 of 199 Map Name: Giant Forest, CA

Scale: 1:24,000 Date of Map: 1987

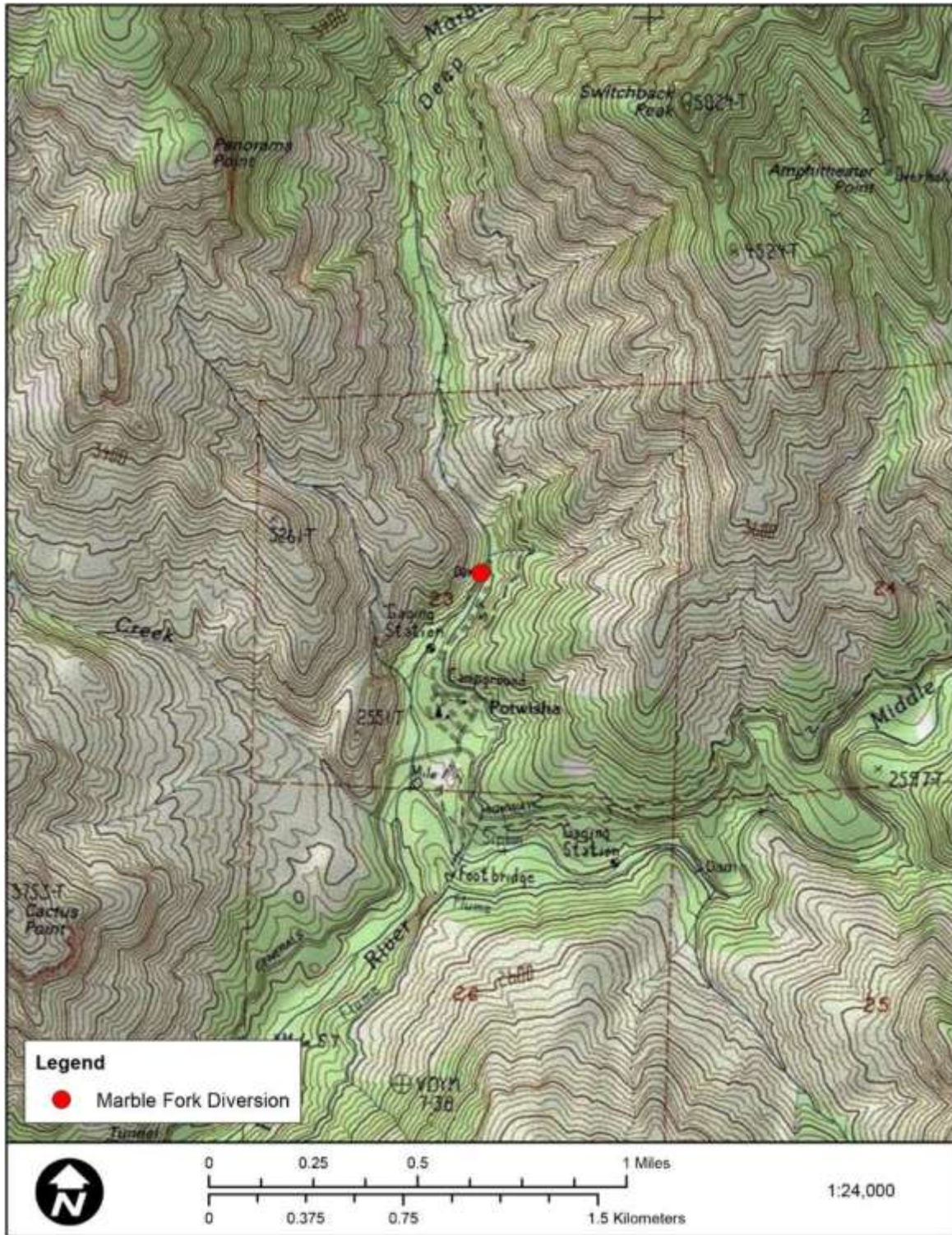

State of California The Resources Agency
DEPARTMENT OF PARKS AND RECREATION
PRIMARY RECORD

Primary # _____
HRI # _____
Trinomial _____
NRHP Status Code _____
Other Listings _____
Review Code _____ Reviewer _____ Date _____

Page 156 of 199 *Resource Name or #: (Assigned by recorder) Marble Fork Flowline and Siphon
P1. Other Identifier: _____

*P2. Location: Not for Publication Unrestricted *a. County Tulare
and (P2c, P2e, and P2b or P2d. Attach a Location Map as necessary.)

*b. USGS 7.5' Quad Giant Forest, Calif. Date 1987; 1987 T 16S; R 29E Sec 23, 26; M.D. B.M.

c. Address City Zip

d. UTM: (Give more than one for large and/or linear resources) Zone 11S, 338887.31 mE/ 4043278.69 mN (beginning);
Zone 11S, 338909.01 mE/ 4042445.15 mN (beginning); Zone 11S, 338818.74 mE/ 4042272.74 mN (siphon)

e. Other Locational Data: (e.g., parcel #, directions to resource, elevation, decimal degrees, etc., as appropriate)

The Marble Fork Flowline and Siphon is accessed by walking a dirt trail approximately 0.25 mile north from Potwisha Campground in Sequoia National Park.

*P3a. Description: (Describe resource and its major elements. Include design, materials, condition, alterations, size, setting, and boundaries)

The Marble Fork Flowline extends along a winding, wooded ridge just above the Marble Fork of the Kaweah River, carrying water from the Marble Fork Diversion to the Middle Fork Flowline via the Marble Fork Siphon (**Photograph 1**). This form inventories both the conduit and the siphon. The approximately 2,800-foot long Marble Fork Flowline is composed of sections of concrete box flume and concrete lined ditch. Flow into the Marble Fork Flowline is controlled by large slide gates at the south end of the Marble Fork Diversion Sandbox, and the conduit begins with an extended flume section. The flume sections are built of thick, reinforced board form concrete slabs with approximately five foot tall walls supported by simple concrete buttresses (**Photograph 2**) (see Continuation Sheet).

*P3b. Resource Attributes: (List attributes and codes) HP20 – Canal/Aqueduct

*P4. Resources Present: Building Structure Object Site District Element of District Other (Isolates, etc.)

P5a. Photograph or Drawing (Photograph required for buildings, structures, and objects.)



P5b. Description of Photo: (view, date, accession #) Photograph 1 Marble Fork Flowline, camera facing southwest, April 19, 2018.

*P6. Date Constructed/Age and Source:
 Historic Prehistoric Both
1913 (SCE)

*P7. Owner and Address:
Southern California Edison
1515 Walnut Grove Avenue
Rosemead, CA 91770

*P8. Recorded by: (Name, affiliation, and address)
Matt Walker and Polly Allen, Cardno,
Inc., 2890 Gateway Oaks Dr., Suite 200,
Sacramento, CA 95833

*P9. Date Recorded: April 17,
2018

*P10. Survey Type: (Describe)
Intensive

*P11. Report Citation: (Cite survey report

and other sources, or enter "none.")

CUL-1: Built Environment Technical Study Report, Kaweah Hydroelectric Project, FERC Project No. 298, January 2019

*Attachments: NONE Location Map Continuation Sheet Building, Structure, and Object Record
 Archaeological Record District Record Linear Feature Record Milling Station Record Rock Art Record
 Artifact Record Photograph Record Other (List):

DPR 523A (9/2013)

*Required information

State of California The Resources Agency Primary #
DEPARTMENT OF PARKS AND RECREATION HRI#
BUILDING, STRUCTURE, AND OBJECT RECORD

*Resource Name or # (Assigned by recorder) Marble Fork Flowline and Siphon *NRHP Status Code
Page 157 of 199

B1. Historic Name: Marble Fork Flowline and Siphon
B2. Common Name: Marble Fork Flowline and Siphon
B3. Original Use: Water Conveyance B4. Present Use: Water Conveyance

*B5. Architectural Style: Rock fill and concrete

*B6. Construction History: (Construction date, alterations, and date of alterations) The Marble Fork Flowline and Siphon were completed in 1913. Since this time, the flowline has been subject to routine maintenance and repairs to damaged sections as necessary.

*B7. Moved? No Yes Unknown Date: _____ Original Location: _____

*B8. Related Features: Kaweah Hydroelectric Project: Kaweah No. 3 Hydroelectric System Historic District (see accompanying records)

B9a. Architect: Mount Whitney Power Company

b. Builder: Unknown

*B10. Significance: Theme Engineering Area Tulare County; California Period of Significance 1913-1916
Property Type Hydroelectric Applicable Criteria A and C

(Discuss importance in terms of historical or architectural context as defined by theme, period, and geographic scope. Also address integrity.)

The Marble Fork Flowline and Siphon appears to meet the criteria for listing in the National Register of Historic Places (NRHP) and the California Register of Historical Resources (CRHR) as a contributor to the Kaweah No. 3 Hydroelectric System Historic District. While the property conveys significance under criteria A and C as part of a significant 1910s hydroelectric system, it does not appear to be individually eligible for listing in the NRHP or CRHR. Rather the significance of the resource is embodied in its functional and physical relationship to the Kaweah No.3 Hydroelectric System as a whole. Please see attached District Record for full evaluation of the facility within the context of the district and Continuation Sheet for physical description and character defining features of this contributing resource.

B11. Additional Resource Attributes: (List attributes and codes)

*B12. References: See footnotes

B13. Remarks:

*B14. Evaluator: Polly Allen and Matt Walker

*Date of Evaluation: December 2018

This space reserved for official comments.



CONTINUATION SHEET

Property Name: Marble Fork Flowline and Siphon

Page 158 of 199

P3a. Description (Continued):

As the terrain along the ridge rises and falls, the flowline transitions from concrete flume to simple concrete lined ditch to maintain its gradually sloped design (**Photograph 3**). Concrete lined ditch sections are slightly wider with rounded edges (**Photograph 4**). Several modern wildlife crossings allow animals to pass over the conduit at various points along the conduit (**Photograph 5**).

The terminus of the Marble Fork Conduit is located in a ditch segment, just above the Middle Fork of the Kaweah River, and serves as the headbox for diversion into the Marble Fork Siphon (**Photograph 6**). Water first passes through a metal trash rack on the south side of the ditch before flowing downhill into the Marble Fork Siphon, a 48-inch riveted steel pipe extending 1,085 feet from the terminus of the Marble Fork Conduit to the Middle Fork Flowline (**Photograph 7**). A layer of concrete protects the siphon where it crosses the bed of the Middle Fork of the Kaweah River, just east of the Middle Fork Bridge (**Photograph 8**). After crossing the river the siphon continues uphill where it empties into the Middle Fork Flowline (**Photograph 9**). See figures for historical imagery of the facility.

Marble Fork Flowline and Siphon is characterized by the following Character Defining Features:

- A winding concrete flume and ditch infrastructure that follows the topography of the Marble Fork canyon
- Flowline location on winding mountain hillside alignment
- Board formed concrete slab sections supported by buttresses coupled with rounded concrete ditch
- A utilitarian headgate that controls flow from the flowline to the siphon
- A partially buried steel pipe siphon that traverses the Middle Fork Kaweah River and rises to join the Middle Fork Flowline
- Wildlife crossings and other appurtenant access crossings are not considered character defining.

CONTINUATION SHEET

Property Name: Marble Fork Flowline and Siphon
Page 159 of 199



Figure 1. Marble Fork Flowline shortly after construction, ca. 1913 (Huntington Library, Call Number 04 - 00276).



Figure 2. Marble Fork Flowline, 1920 (Huntington Library, Call Number 02 - 06311).

CONTINUATION SHEET

Property Name: Marble Fork Flowline and Siphon
Page 160 of 199



Figure 3. Marble Fork Siphon under construction, ca. 1913 (Huntington Library, Call Number 04 - 00137).

CONTINUATION SHEET

Property Name: Marble Fork Flowline and Siphon
Page 161 of 199

Photographs (Continued):



Photograph 2. Marble Fork Flowline showing flume section, camera facing southeast. April 17, 2018.



Photograph 3. Marble Fork Flowline showing ditch section transitioning to flume, camera facing south. April 17, 2018.

CONTINUATION SHEET

Property Name: Marble Fork Flowline and Siphon
Page 162 of 199



Photograph 4. Marble Fork Flowline showing concrete ditch section, camera facing north. April 17, 2018.



Photograph 5. Wildlife crossing on Marble Fork Flowline, camera facing southeast. April 17, 2018.

CONTINUATION SHEET

Property Name: Marble Fork Flowline and Siphon
Page 163 of 199



Photograph 6. End of Marble Fork Conduit and headgate for Marble Fork Siphon, camera facing east. April 17, 2018.



Photograph 7. Marble Fork Siphon, camera facing southeast. April 17, 2018.

CONTINUATION SHEET

Property Name: Marble Fork Flowline and Siphon
Page 164 of 199



Photograph 8. Siphon covered by concrete at crossing of the Middle Fork of the Kaweah River, camera facing northeast. April 17, 2018.



Photograph 9. Marble Fork Siphon emptying into Middle Fork Flowline, camera facing northeast. April 17, 2018.

LOCATION MAP

Property Name: Marble Fork Flowline and Siphon
Page 165 of 199 **Map Name:** Giant Forest, CA

Scale: 1: 24,000 **Date of Map:** 1987



State of California The Resources Agency
DEPARTMENT OF PARKS AND RECREATION
PRIMARY RECORD

Primary # _____
HRI # _____
Trinomial _____
NRHP Status Code _____
Other Listings _____
Review Code _____ Reviewer _____ Date _____

Page 166 of 199 *Resource Name or #: (Assigned by recorder) Middle Fork Diversion

P1. Other Identifier: _____

*P2. Location: Not for Publication Unrestricted *a. County Tulare
and (P2c, P2e, and P2b or P2d. Attach a Location Map as necessary.)

*b. USGS 7.5' Quad Giant Forest, Calif. Date 1987 T 16S; R 29E Sec 25; M.D. B.M.

c. Address City Zip

d. UTM: (Give more than one for large and/or linear resources) Zone 11S, 339721.06 mE/ 4042228.90 mN

e. Other Locational Data: (e.g., parcel #, directions to resource, elevation, decimal degrees, etc., as appropriate)

The Middle Fork Diversion is accessed by parking just below the Potwisha Campground and walking approximately 0.75 miles, crossing the Middle Fork Kaweah River, and walking along the Middle Fork Flowline to the diversion.

*P3a. Description: (Describe resource and its major elements. Include design, materials, condition, alterations, size, setting, and boundaries)

The Middle Fork Diversion is located in the steep, wooded canyon of the Middle Fork Kaweah River, just south of State Route 198 in Sequoia National Park, and is similar in design to the Marble Fork Diversion. This form inventories the Middle Fork Diversion, including the Middle Fork Diversion Dam as well as its associated intake structure. Situated at an elevation of approximately 2,180 feet, the Middle Fork Diversion Dam is a simple six-foot tall overflow concrete gravity dam with a crest length of approximately 50 feet (**Photograph 1**). Impounded water is diverted into an approximately 300-foot-long concrete sandbox (**Photograph 2**). The west wall of the sandbox serves as an ungated spillway, allowing excess water to flow freely back into the river (**Photograph 3**) (see Continuation Sheet).

*P3b. Resource Attributes: (List attributes and codes) HP11 – Engineering structure; HP21 – Dam

*P4. Resources Present: Building Structure Object Site District Element of District Other (Isolates, etc.)

P5a. Photograph or Drawing (Photograph required for buildings, structures, and objects.)



*P5b. Description of Photo: (view, date, accession #) Photograph 1 Middle Fork Diversion, camera facing south, April 17, 2018.

*P6. Date Constructed/Age and Source:
 Historic Prehistoric Both
1913 (SCE)

*P7. Owner and Address:
Southern California Edison
1515 Walnut Grove Avenue
Rosemead, CA 91770

*P8. Recorded by: (Name, affiliation, and address)
Matt Walker and Polly Allen, Cardno,
Inc., 2890 Gateway Oaks Dr., Suite 200,
Sacramento, CA 95833

*P9. Date Recorded: April 19,
2018

*P10. Survey Type: (Describe)
Intensive

*P11. Report Citation: (Cite survey report and other sources, or enter "none.")

CUL-1: Built Environment Technical Study Report, Kaweah Hydroelectric Project, FERC Project No. 298, January 2019

*Attachments: NONE Location Map Continuation Sheet Building, Structure, and Object Record
 Archaeological Record District Record Linear Feature Record Milling Station Record Rock Art Record
 Artifact Record Photograph Record Other (List):

BUILDING, STRUCTURE, AND OBJECT RECORD

*Resource Name or # (Assigned by recorder) Middle Fork Diversion *NRHP Status Code
Page 167 of 199

- B1. Historic Name: Middle Fork Diversion
B2. Common Name: Middle Fork Diversion
B3. Original Use: Dam B4. Present Use: Dam
*B5. Architectural Style: Concrete gravity

*B6. Construction History: (Construction date, alterations, and date of alterations) The Middle Fork Diversion was completed in 1913. Since construction, the Middle Fork Diversion has remained largely unaltered, with the exception of regular maintenance and repairs to keep the facility operating efficiently.

*B7. Moved? No Yes Unknown Date: _____ Original Location: _____

*B8. Related Features: Kaweah Hydroelectric Project: Kaweah No. 3 Hydroelectric System Historic District (see accompanying records)

B9a. Architect: Mount Whitney Power Company

b. Builder: Unknown

*B10. Significance: Theme Engineering Area Tulare County; California Period of Significance 1913-1916
Property Type Hydroelectric Applicable Criteria A and C

(Discuss importance in terms of historical or architectural context as defined by theme, period, and geographic scope. Also address integrity.)

The Middle Fork Diversion appears to meet the criteria for listing in the National Register of Historic Places (NRHP) and the California Register of Historical Resources (CRHR) as a contributor to the Kaweah No. 3 Hydroelectric System Historic District. While the property conveys significance under criteria A and C as part of a significant 1910s hydroelectric system, it does not appear to be individually eligible for listing in the NRHP or CRHR. Rather the significance of the resource is embodied in its functional and physical relationship to the Kaweah No.3 Hydroelectric System as a whole. Please see attached District Record for full evaluation of the facility within the context of the district and Continuation Sheet for physical description and character defining features of this contributing resource.

B11. Additional Resource Attributes: (List attributes and codes)

*B12. References: See footnotes

B13. Remarks:

*B14. Evaluator: Polly Allen and Matt Walker

*Date of Evaluation: December 2018

This space reserved for official comments.



CONTINUATION SHEET

Property Name: Middle Fork Diversion

Page 168 of 199

P3a. Description (Continued):

Two manually operated slide gates located along the sandbox's north side allow for the release of excess water. One slide gate is situated near the structure's west end and is accessed using a grated metal platform with tubular metal hand rails, while a second slide gate is accessed using a modern grated steel walkway with tubular metal hand rails crossing the structure near the middle of the sandbox (**Photographs 3 and 4**). Before leaving the sandbox, water passes through a large concrete trash rack structure, with flow into the Middle Fork Flowline controlled by dual manually operated iron slide gates (**Photograph 5**). See figures for historical imagery of the facility.

Character Defining Features of the Middle Fork Diversion include:

- The dam's low profile placement and orientation on the Middle Fork Kaweah River
- Concrete diversion structure and sandbox placed on the bank of the river
- The dam's functional relationship to the Middle Fork Flowline
- Utilitarian flow regulating gates and trash rack
- Safety rails and fences and other appurtenant utility features are not character defining

CONTINUATION SHEET

Property Name: Middle Fork Diversion
Page 169 of 199



Figure 1. Middle Fork Diversion under construction, ca. 1912 (Huntington Library, Call Number 04 - 00271).



Figure 2. Middle Fork Diversion nearly complete, ca. 1912 (Huntington Library, Call Number 04 - 00212).

CONTINUATION SHEET

Property Name: Middle Fork Diversion

Page 170 of 199

Photographs (Continued):



Photograph 2. Middle Fork Diversion Dam, camera facing northeast. April 17, 2018.



Photograph 3. Concrete sandbox, camera facing west. April 17, 2018.

CONTINUATION SHEET

Property Name: Middle Fork Diversion

Page 171 of 199



Photograph 4. Sandbox, note ungated spillway and two slide gates, camera facing east. April 17, 2018.



Photograph 5. Middle Fork Diversion trash rack, and slide gates, camera facing west. April 17, 2018.

LOCATION MAP

Property Name: Middle Fork Diversion

Page 172 of 199 Map Name: Giant Forest, CA

Scale: 1: 24,000 Date of Map: 1987

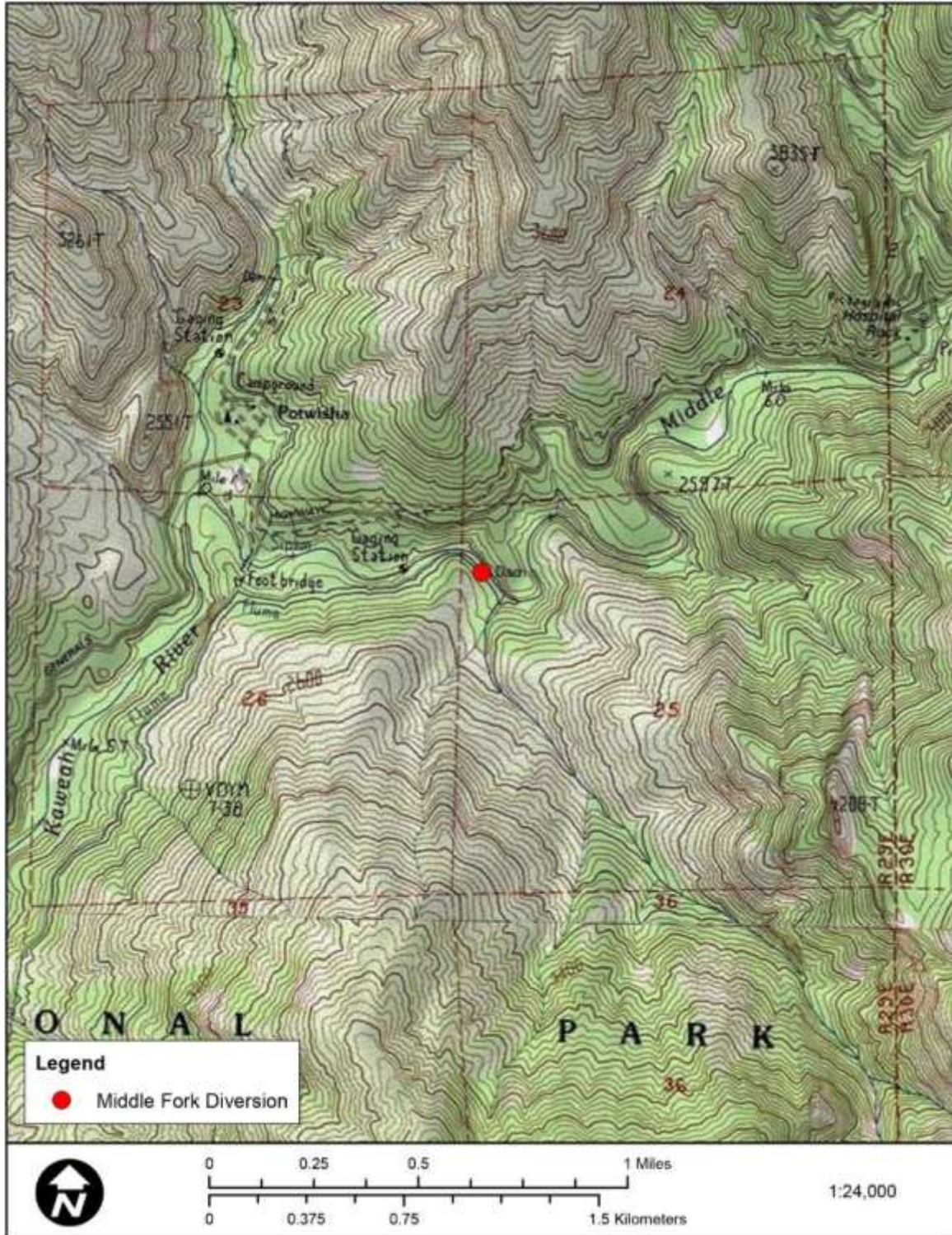

State of California The Resources Agency
DEPARTMENT OF PARKS AND RECREATION
PRIMARY RECORD

Primary # _____
HRI # _____
Trinomial _____
NRHP Status Code _____
Other Listings _____
Review Code _____ Reviewer _____ Date _____

Page 173 of 199 *Resource Name or #: (Assigned by recorder) Middle Fork / Kaweah No. 3 Flowline
P1. Other Identifier: _____

*P2. Location: Not for Publication Unrestricted *a. County Tulare
and (P2c, P2e, and P2b or P2d. Attach a Location Map as necessary.)

*b. USGS 7.5' Quad Giant Forest; Kaweah, Calif. Date 1987; 1987 T 16 and 17S; R 29E Sec 25, 26; 3, 35, 37 M.D. B.M.

c. Address City Zip

d. UTM: (Give more than one for large and/or linear resources) Zone 11S, 339652.55 mE/ 4042310.48 (beginning);
Zone 11S, 336286.12 mE/ 4039203.47 (end)

e. Other Locational Data: (e.g., parcel #, directions to resource, elevation, decimal degrees, etc., as appropriate)

The Middle Fork Flowline is accessed by crossing the Middle Fork of the Kaweah River, just south of the Potwisha Campground, and walking approximately 0.1 mile uphill to a point along the flowline approximately 0.75 mile west of the Middle Fork Diversion.

*P3a. Description: (Describe resource and its major elements. Include design, materials, condition, alterations, size, setting, and boundaries)

The Middle Fork Flowline extends approximately 4.5 miles along a winding, wooded ridge on a steep hillside above the Kaweah River, carrying water from the Middle Fork and Marble Fork Diversions to the Kaweah No. 3 Forebay (**Photograph 1**). The flowline is comprised primarily of extended spans of concrete box flume, with a short concrete-lined ditch segment. After passing through two large slide gates at the south end of the Middle Fork Diversion Sandbox, diverted water enters a concrete box flume travelling gradually downslope in a generally westerly direction (**Photograph 2**) (see Continuation Sheet).

*P3b. Resource Attributes: (List attributes and codes) HP20 – Canal/Aqueduct

P5a. Photograph or Drawing (Photograph required for buildings, structures, and objects.)



*P4. Resources Present: Building Structure Object Site District Element of District Other (Isolates, etc.)

*P5b. Description of Photo: (view, date, accession #) Photograph 1 Middle Fork Flowline, camera facing southwest, April 17, 2018.

*P6. Date Constructed/Age and Source: Historic Prehistoric Both
1913 (SCE)

*P7. Owner and Address:
Southern California Edison
1515 Walnut Grove Avenue
Rosemead, CA 91770

*P8. Recorded by: (Name, affiliation, and address)
Matt Walker and Polly Allen, Cardno,
Inc., 2890 Gateway Oaks Dr., Suite 200,
Sacramento, CA 95833

*P9. Date Recorded: April 17, 2018

*P10. Survey Type: (Describe)
Intensive

*P11. Report Citation: (Cite survey report and other sources, or enter "none.")

CUL-1: Built Environment Technical Study Report, Kaweah Hydroelectric Project, FERC Project No. 298, January 2019

*Attachments: NONE Location Map Continuation Sheet Building, Structure, and Object Record
 Archaeological Record District Record Linear Feature Record Milling Station Record Rock Art Record
 Artifact Record Photograph Record Other (List):

BUILDING, STRUCTURE, AND OBJECT RECORD

*Resource Name or # (Assigned by recorder) Middle Fork / Kaweah No. 3 Flowline *NRHP Status Code

Page 174 of 199

B1. Historic Name: Middle Fork Flowline

B2. Common Name: Middle Fork Flowline

B3. Original Use: Water Conveyance B4. Present Use: Water Conveyance

*B5. Architectural Style: Utilitarian; concrete flowline

*B6. Construction History: (Construction date, alterations, and date of alterations) The Middle Fork Flowline was completed in 1913. Between 1946 and 1947, the flume was lined with a layer of ½ inch reinforced gunite.

*B7. Moved? No Yes Unknown Date: _____ Original Location:

*B8. Related Features: Kaweah Hydroelectric Project; Kaweah No. 3 Hydroelectric System Historic District (see accompanying records)

B9a. Architect: Mount Whitney Power Company

b. Builder: Unknown

*B10. Significance: Theme Engineering Area Tulare County; California Period of Significance 1913-1916
Property Type Hydroelectric Applicable Criteria A and C

(Discuss importance in terms of historical or architectural context as defined by theme, period, and geographic scope. Also address integrity.)

The Middle Fork Flowline appears to meet the criteria for listing in the National Register of Historic Places (NRHP) and the California Register of Historical Resources (CRHR) as a contributor to the Kaweah No. 3 Hydroelectric System Historic District. While the property conveys significance under criteria A and C as part of a significant 1910s hydroelectric system, it does not appear to be individually eligible for listing in the NRHP or CRHR. Rather the significance of the resource is embodied in its functional and physical relationship to the Kaweah No.3 Hydroelectric System as a whole. Please see attached District Record for full evaluation of the facility within the context of the district and Continuation Sheet for physical description and character defining features of this contributing resource.

B11. Additional Resource Attributes: (List attributes and codes)

*B12. References: See Footnotes

B13. Remarks:

*B14. Evaluator: Polly Allen and Matt Walker

*Date of Evaluation: December 2018

This space reserved for official comments.



CONTINUATION SHEET

Property Name: Middle Fork / Kaweah No. 3 Flowline

Page 175 of 199

P3a. Description (Continued):

The design of the extended flume segments of the Middle Fork Flowline mirrors that of the Marble Fork Conduit, with its thick, reinforced board form concrete slab construction with approximately five foot tall walls supported by simple concrete buttresses (**Photograph 3**). A simple wood board catwalk located directly on top of the flume provides access to roughly the first 300 feet of the flowline as it wraps around the steep, rugged hillside near the Middle Fork Diversion Sandbox (**Photograph 4**). The concrete flume typically rests directly on the ground, however concrete footings are used where the ground is uneven (**Photograph 5**). Several of these footings have been replaced in the years since constructions. Three short sections of modern wood box flume are supported by wood trellis structures where the original concrete box flowline has been washed out (**Photograph 6**).

The flowline receives additional water from the Marble Fork Conduit via the Marble Fork Siphon, which stretches across the Kaweah River Valley. The riveted steel pipe penetrates the concrete flume walls of the Middle Fork Flowline at a sharp bend in the channel, approximately 3,230 feet from the Middle Fork Diversion (**Photograph 6**). From this junction, the flowline continues in its generally westerly direction toward the Kaweah No. 3 Forebay and consists of approximately 5,200 feet of simple, concrete-lined ditch and 15,700 feet of concrete box flume. Concrete lined ditch sections are slightly wider than the flume, flush with the ground, with rounded edges (**Photograph 7**). Several modern wildlife crossings allow animals to pass over the conduit at various points along the conduit (**Photograph 8**).

The Middle Fork Flowline has remained largely unaltered since construction, with the exception of routine maintenance and necessary repairs and the addition of a one-half inch layer of gunite lining along the flowline added between 1946 and 1947. See figures for historical imagery of the facility.

The Middle Fork Flowline is characterized by the following Character Defining Features:

- A winding concrete flume and ditch infrastructure that follows the topography of the Middle Fork canyon
- Flowline location on winding mountain hillside alignment
- Stone wall foundational structures undergirding portions of the flowline
- Board formed concrete slab sections supported by buttresses coupled with rounded concrete ditch
- Operational connection to the Middle Fork Diversion, Marble Fork Siphon, and Kaweah No. 3 Forebay
- Wildlife crossings and other appurtenant access crossings are not considered character defining.
- Modern wood trestle sections are not considered character defining features

CONTINUATION SHEET

Property Name: Middle Fork / Kaweah No. 3 Flowline

Page 176 of 199

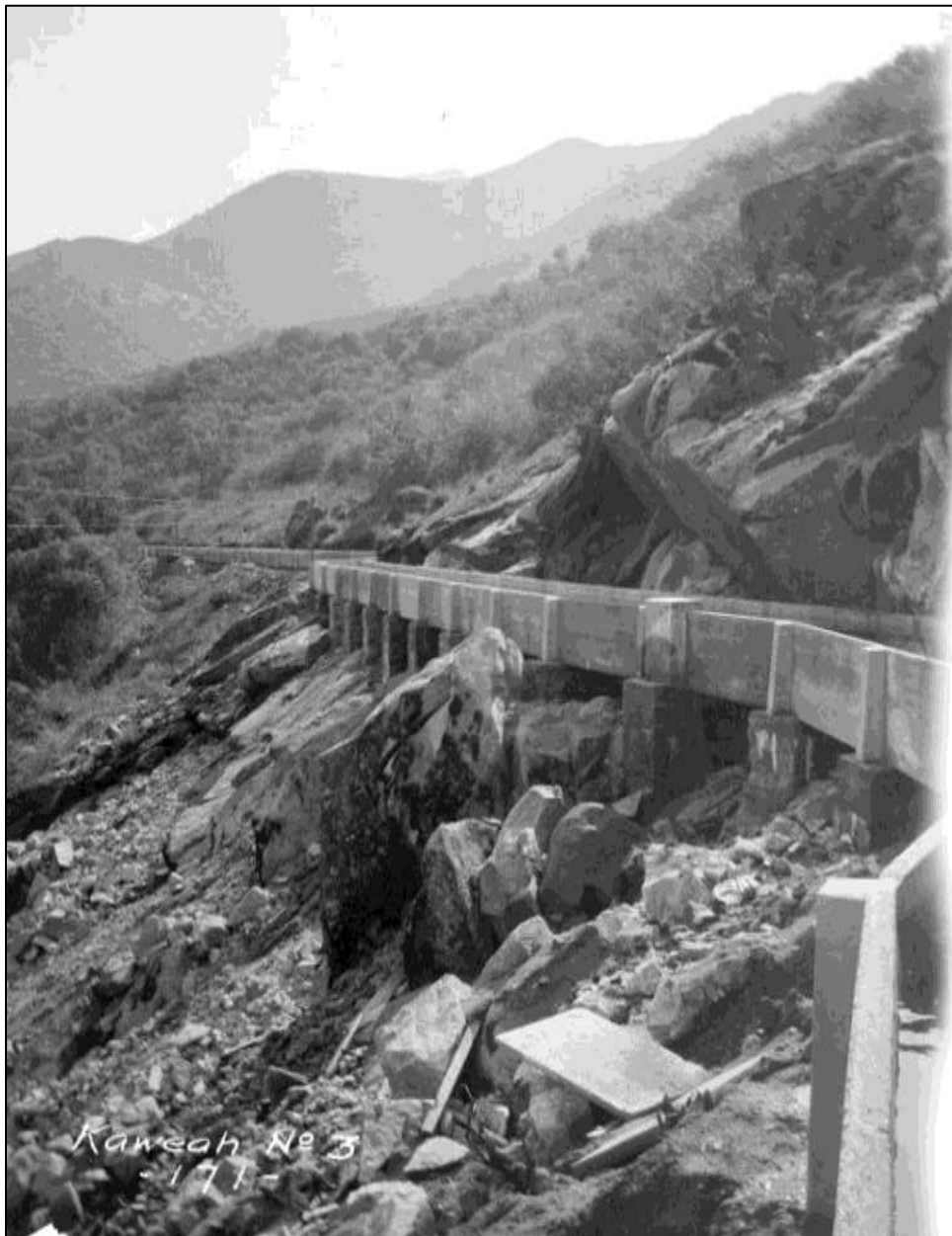

Figure 1. Middle Fork Conduit shortly after completion, ca. 1913 (Huntington Library, Call Number 04 - 00171).

CONTINUATION SHEET

Property Name: Middle Fork / Kaweah No. 3 Flowline

Page 177 of 199

Photographs (Continued):



Photograph 2. Middle Fork Flowline, camera facing northeast. April 17, 2018.



Photograph 3. Middle Fork Flowline, camera facing southwest. April 17, 2018.

CONTINUATION SHEET

Property Name: Middle Fork / Kaweah No. 3 Flowline

Page 178 of 199



Photograph 4. Middle Fork Flowline catwalk near Middle Fork Diversion, camera facing northeast. April 17, 2018.



Photograph 5. Footing on Middle Fork Flowline flume, note replacement footing, camera facing west. April 17, 2018.

CONTINUATION SHEET

Property Name: Middle Fork / Kaweah No. 3 Flowline

Page 179 of 199



Photograph 6. Modern wood flume section, camera facing south. April 17, 2018.



Photograph 7. Junction of Marble Fork Siphon and the Middle Fork Flowline, camera facing east. April 17, 2018.

CONTINUATION SHEET

Property Name: Middle Fork / Kaweah No. 3 Flowline

Page 180 of 199



Photograph 8. Concrete-lined ditch segment along Middle Fork Flowline, camera facing south. April 17, 2018.



Photograph 9. Wildlife crossing along Middle Fork Flowline, camera facing south. April 17, 2018

LOCATION MAP

Property Name: Middle Fork / Kaweah No. 3 Flowline

Page 181 of 199 Map Name: Giant Forest, CA

Scale: 1:24,000 Date of Map: 1987

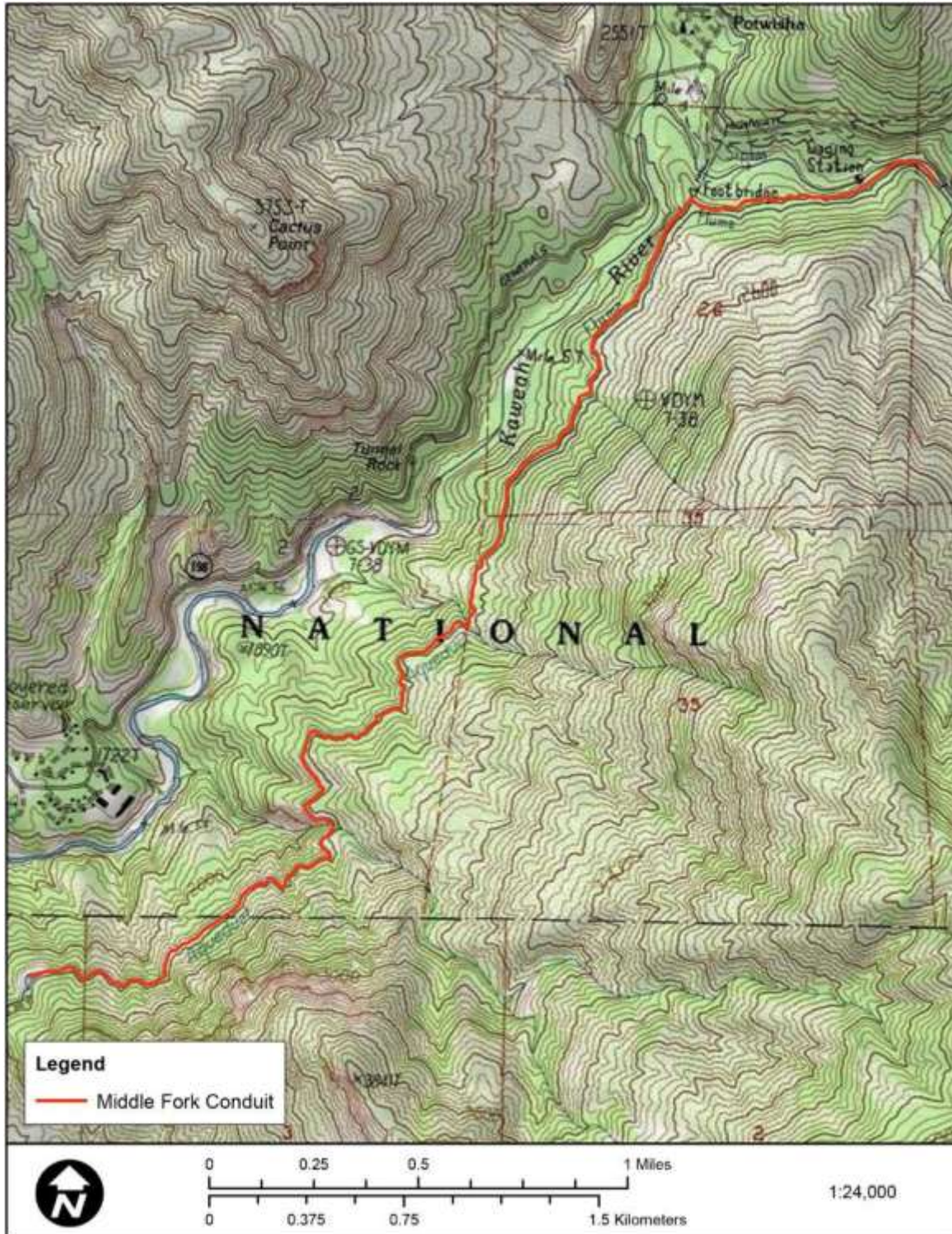

State of California The Resources Agency
DEPARTMENT OF PARKS AND RECREATION
PRIMARY RECORD

Primary # _____
HRI # _____
Trinomial _____
NRHP Status Code _____
Other Listings _____
Review Code _____ Reviewer _____ Date _____

Page 182 of 199 *Resource Name or #: (Assigned by recorder) Kaweah No. 3 Forebay
P1. Other Identifier: _____

*P2. Location: Not for Publication Unrestricted *a. County Tulare
and (P2c, P2e, and P2b or P2d. Attach a Location Map as necessary.)

*b. USGS 7.5' Quad Case Mountain, Calif. Date 1987 T 16S; R 29E Sec 37; M.D. B.M.

c. Address City Zip

d. UTM: (Give more than one for large and/or linear resources) Zone 11S, 336224.81 mE/ 4039179.67 mN

e. Other Locational Data: (e.g., parcel #, directions to resource, elevation, decimal degrees, etc., as appropriate)

Kaweah No. 3 Forebay is accessed by driving approximately 1.7 miles up SCE's Kaweah No. 3 Forebay Road from State Route 198.

*P3a. Description: (Describe resource and its major elements. Include design, materials, condition, alterations, size, setting, and boundaries)

The Kaweah No. 3 Forebay serves as the terminus of the Middle Fork / Kaweah No. 3 Flowline and the regulating facility for electrical generation at Kaweah No. 3 Powerhouse (**Photograph 1**). Located on a hillside ridge approximately 0.4 miles east of the powerhouse, the Kaweah No. 3 Forebay is a gunite-lined embankment forebay with a capacity of approximately 11 acre feet (**Photograph 2**). Water enters the oval-shaped reservoir by passing through a metal trash rack at the north end of the forebay, at its connection to the Middle Fork Conduit, with flow into the reservoir controlled by a pair of manually controlled iron slide gates set in a simple concrete structure (**Photograph 3**) (see Continuation Sheet).

*P3b. Resource Attributes: (List attributes and codes) HP11 – Engineering structure; HP21 – Dam

P5a. Photograph or Drawing (Photograph required for buildings, structures, and objects.)



*P4. Resources Present: Building Structure Object Site District Element of District Other (Isolates, etc.)

*P5b. Description of Photo: (view, date, accession #) Photograph 1 Kaweah No. 3 Forebay, camera facing southwest, April 19, 2018.

*P6. Date Constructed/Age and Source: Historic Prehistoric Both 1913 (SCE)

*P7. Owner and Address: Southern California Edison
1515 Walnut Grove Avenue
Rosemead, CA 91770

*P8. Recorded by: (Name, affiliation, and address) Matt Walker and Polly Allen, Cardno, Inc., 2890 Gateway Oaks Dr., Suite 200, Sacramento, CA 95833

*P9. Date Recorded: April 19, 2018

*P10. Survey Type: (Describe) Intensive

*P11. Report Citation: (Cite survey report and other sources, or enter "none.")

CUL-1: Built Environment Technical Study Report, Kaweah Hydroelectric Project, FERC Project No. 298, January 2019

*Attachments: NONE Location Map Continuation Sheet Building, Structure, and Object Record
 Archaeological Record District Record Linear Feature Record Milling Station Record Rock Art Record
 Artifact Record Photograph Record Other (List):

BUILDING, STRUCTURE, AND OBJECT RECORD

*Resource Name or # (Assigned by recorder) Kaweah No. 3 Forebay *NRHP Status Code
Page 183 of 199

B1. Historic Name: Kaweah No. 3 Forebay
B2. Common Name: Kaweah No. 3 Forebay
B3. Original Use: Forebay B4. Present Use: Forebay

*B5. Architectural Style: Utilitarian

*B6. Construction History: (Construction date, alterations, and date of alterations) The Kaweah No. 3 Forebay was completed in 1913. Forebay relined with gunite in 1947. In 2012, the forebay was again relined with a layer of gunite.

*B7. Moved? No Yes Unknown Date: _____ Original Location: _____

*B8. Related Features: Kaweah Hydroelectric Project: Kaweah No. 3 Hydroelectric System Historic District (see accompanying records)

B9a. Architect: Mount Whitney Power Company

b. Builder: Unknown

*B10. Significance: Theme Engineering Area Tulare County; California Period of Significance 1913-1916
Property Type Hydroelectric Applicable Criteria A and C

(Discuss importance in terms of historical or architectural context as defined by theme, period, and geographic scope. Also address integrity.)

The Kaweah No. 3 Forebay appears to meet the criteria for listing in the National Register of Historic Places (NRHP) and the California Register of Historical Resources (CRHR) as a contributor to the Kaweah No. 3 Hydroelectric System Historic District. While the property conveys significance under criteria A and C as part of a significant 1910s hydroelectric system, it does not appear to be individually eligible for listing in the NRHP or CRHR. Rather the significance of the resource is embodied in its functional and physical relationship to the Kaweah No.3 Hydroelectric System as a whole. Please see attached District Record for full evaluation of the facility within the context of the district and Continuation Sheet for physical description and character defining features of this contributing resource.

B11. Additional Resource Attributes: (List attributes and codes)

*B12. References: See Footnotes

B13. Remarks:

*B14. Evaluator: Polly Allen and Matt Walker
*Date of Evaluation: December, 2018

This space reserved for official comments.



CONTINUATION SHEET

Property Name: Kaweah No. 3 Forebay

Page 184 of 199

P3a. Description (Continued):

Water exits the reservoir by passing through a metal trash rack, below water level, at the south side of the reservoir and into a steel horizontal pipe connecting to the Kaweah No. 3 vertical Penstock. Flow into the drainage pipe is controlled by a manually operated slide gate (**Photograph 4**). An approximately 75 foot long concrete-lined spillway chute extends from the forebay's north end, at its connection with the Middle Fork Conduit, and discharges water into a natural drainage. The discharge water flows approximately 0.3 mile downslope into the Kaweah River (**Photograph 5**). Refer to figures for historical imagery of the facility.

The Kaweah No. 3 Forebay is characterized by the following Character Defining Features:

- Forebay location at terminus of Middle Fork / Kaweah No. 3 Flowline and above the penstock of Powerhouse No. 3
- Concrete lined forebay pool
- Utilitarian control gates and spillway
- Fencing and other appurtenant access and utility features are not considered character defining

CONTINUATION SHEET

Property Name: Kaweah No. 3 Forebay

Page 185 of 199



Figure 1. Kaweah No. 3 Forebay near completion, ca. 1912 (Huntington Library, Call Number 04 - 00504).



Figure 2. Kaweah No. 3 Forebay newly lined with gunite, 1947 (Huntington Library, Call Number 02 - 27826).

CONTINUATION SHEET

Property Name: Kaweah No. 3 Forebay

Page 186 of 199

Photographs (Continued):



Photograph 2. Kaweah No. 3 Forebay, camera facing west. April 17, 2018.



Photograph 3. Connection of Middle Fork Conduit with Kaweah No. 3 Forebay, camera facing west. April 17, 2018.

CONTINUATION SHEET

Property Name: Kaweah No. 3 Forebay

Page 187 of 199



Photograph 4. Kaweah No. 3 Forebay outlet slide gate, camera facing south. April 17, 2018.



Photograph 5. Kaweah No. 3 Forebay spillway, camera facing east. April 17, 2018.

LOCATION MAP

Property Name: Kaweah No. 3 Forebay

Page 188 of 199 Map Name: Case Mountain, CA

Scale: 1: 24,000

Date of Map: 1987

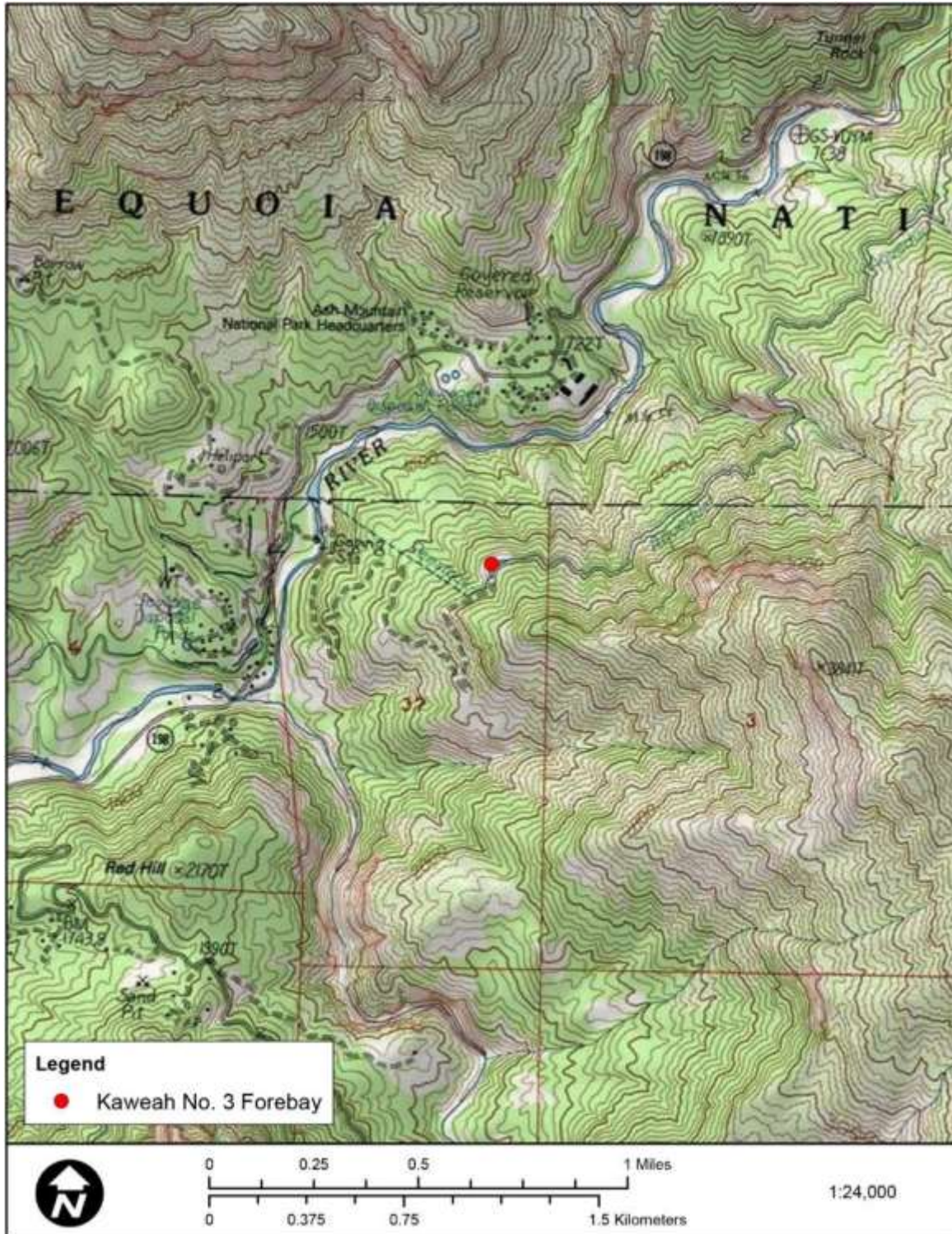

State of California The Resources Agency
 DEPARTMENT OF PARKS AND RECREATION
PRIMARY RECORD

Primary # _____ HRI # _____
 Trinomial _____
 NRHP Status Code _____
 Other Listings _____
 Review Code _____ Reviewer _____ Date _____

Page 189 of 199 *Resource Name or #: (Assigned by recorder) Kaweah Hydroelectric Project Stream Gages
 P1. Other Identifier: _____

*P2. Location: Not for Publication Unrestricted *a. County Tulare

and (P2c, P2e, and P2b or P2d. Attach a Location Map as necessary.)

*b. USGS 7.5' Quad Kaweah, Calif. Date 1957 T 16S; R 29E Sec 14; M.D. B.M.

c. Address City Zip

d. UTM: (Give more than one for large and/or linear resources) Zone , mE/ mN

e. Other Locational Data: (e.g., parcel #, directions to resource, elevation, decimal degrees, etc., as appropriate)

See description for detailed location of gages.

*P3a. Description: (Describe resource and its major elements. Include design, materials, condition, alterations, size, setting, and boundaries)

The Kaweah Hydroelectric Project utilizes eight stream gaging stations to measure the flow of water near its many facilities along the Kaweah River. These stream gages are generally located just below the system's dams and powerhouse, strategically positioned to monitor water released by the system's dams and passing through the three powerhouses. The gages consists cylindrical riveted corrugated metal casings with conical tops. Small doors on the side of the gaging stations allow access to internal gaging and monitoring equipment. While gages have been employed since Project inception, only one of the current gages, Gage 201, which is located below the Kaweah No. 3 Powerhouse, dates to the historic period, 1952. The other extant gages are modern-era replacements to original gages (see Continuation Sheet).

*P3b. Resource Attributes: (List attributes and codes) HP11 – Engineering structure

*P4. Resources Present: Building Structure Object Site District Element of District Other (Isolates, etc.)

P5b. Description of Photo: (view, date, accession #) Photograph 1 Stream Gage 201 near Kaweah No. 3 Powerhouse, camera facing northeast, April 19, 2018.

P5a. Photograph or Drawing (Photograph required for buildings, structures, and objects.)



*P6. Date Constructed/Age and Source:
 Historic Prehistoric Both
1952-2005 (SCE)

*P7. Owner and Address:
Southern California Edison
1515 Walnut Grove Avenue
Rosemead, CA 91770

*P8. Recorded by: (Name, affiliation, and address)
Matt Walker and Polly Allen, Cardno,
Inc., 2890 Gateway Oaks Dr., Suite 200,
Sacramento, CA 95833

*P9. Date Recorded: April 17-19, 2018

*P10. Survey Type: (Describe) Intensive

*P11. Report Citation: (Cite survey report and other sources, or enter "none.")

CUL-1: Built Environment Technical Study Report, Kaweah Hydroelectric Project, FERC Project No. 298, January 2019

*Attachments: NONE Location Map Continuation Sheet Building, Structure, and Object Record
 Archaeological Record District Record Linear Feature Record Milling Station Record Rock Art Record
 Artifact Record Photograph Record Other (List):

*Resource Name or # (Assigned by recorder) Kaweah Hydroelectric Project Stream Gages *NRHP Status Code
 Page 190 of 199

B1. Historic Name: Kaweah Hydroelectric Project Stream Gages

B2. Common Name: Stream Gages

B3. Original Use: Gaging B4. Present Use: Gaging

*B5. Architectural Style: Utilitarian

*B6. Construction History: (Construction date, alterations, and date of alterations) The gages have been in service from 1952 to the present. Current gages are replacements to earlier Project gages, replaced and upgraded over time.

*B7. Moved? No Yes Unknown Date: _____ Original Location:

*B8. Related Features: Kaweah Hydroelectric Project (see accompanying records)

B9a. Architect: None

b. Builder: Unknown

*B10. Significance: Theme n/a Area n/a Period of Significance n/a Property Type n/a Applicable Criteria n/a
 (Discuss importance in terms of historical or architectural context as defined by theme, period, and geographic scope. Also address integrity.)

Kaweah Hydroelectric Project Stream Gages do not appear to meet the criteria for listing in the National Register of Historic Places (NRHP) or the California Register of Historical Resources (CRHR) as an individual property or as a contributor to any NRHP or CRHR Historic District. Because the gages are an operational element of the Kaweah Hydroelectric Project, which includes three operationally related hydroelectric systems, the facility was evaluated for NRHP and CRHR eligibility within the context of the larger operational hydroelectric system. Please see attached District Record for full historic context and evaluation of the stream gages. Please refer to accompanying Continuation Sheets for full description.

B11. Additional Resource Attributes: (List attributes and codes)

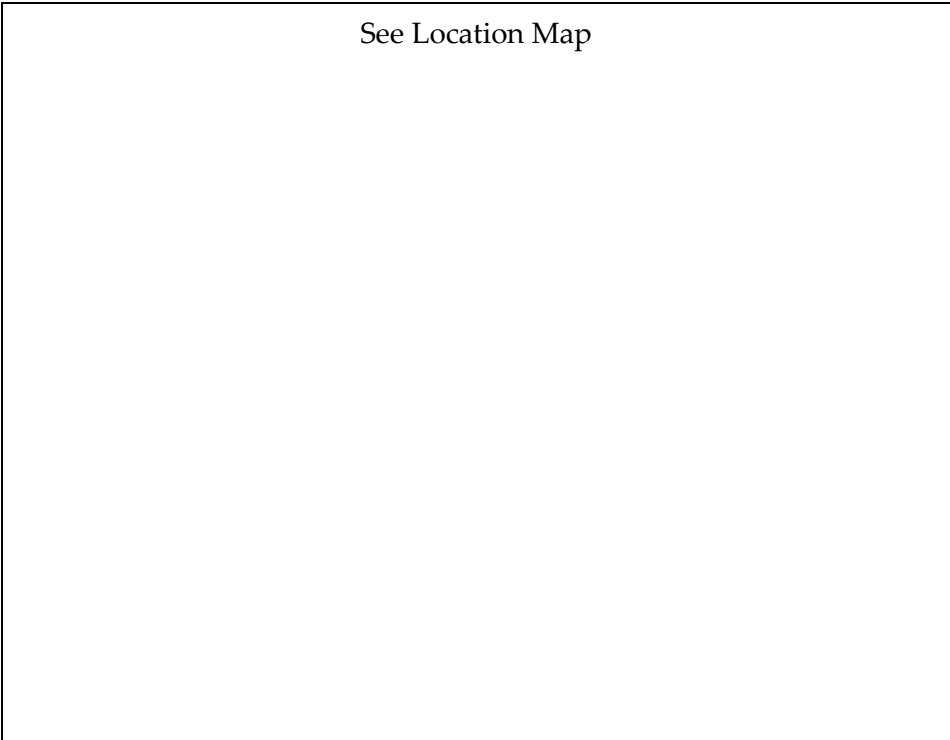

*B12. References: See footnotes

B13. Remarks:

*B14. Evaluator: Polly Allen and Matt Walker

*Date of Evaluation: December 2018

This space reserved for official comments.

CONTINUATION SHEET

Property Name: Kaweah Hydroelectric Project Stream Gages

Page 191 of 199

P3a. Description (Continued):

SCE Gage #	USGS Station #	Construction Date
201	USGS 11208730	1952
201a		1995
202		2002
200a	USGS 11208800	2002
203	USGS 11208600	1993
204a		2005
205a	USGS 11208818	2002
206a	USGS 11208565	2002

LOCATION MAP

Property Name: Kaweah Hydroelectric Project Stream Gages

Page 192 of 199 Map Name: Case Mountain and Kaweah, CA Scale: 1: 24,000 Date of Map: 1986; 1987

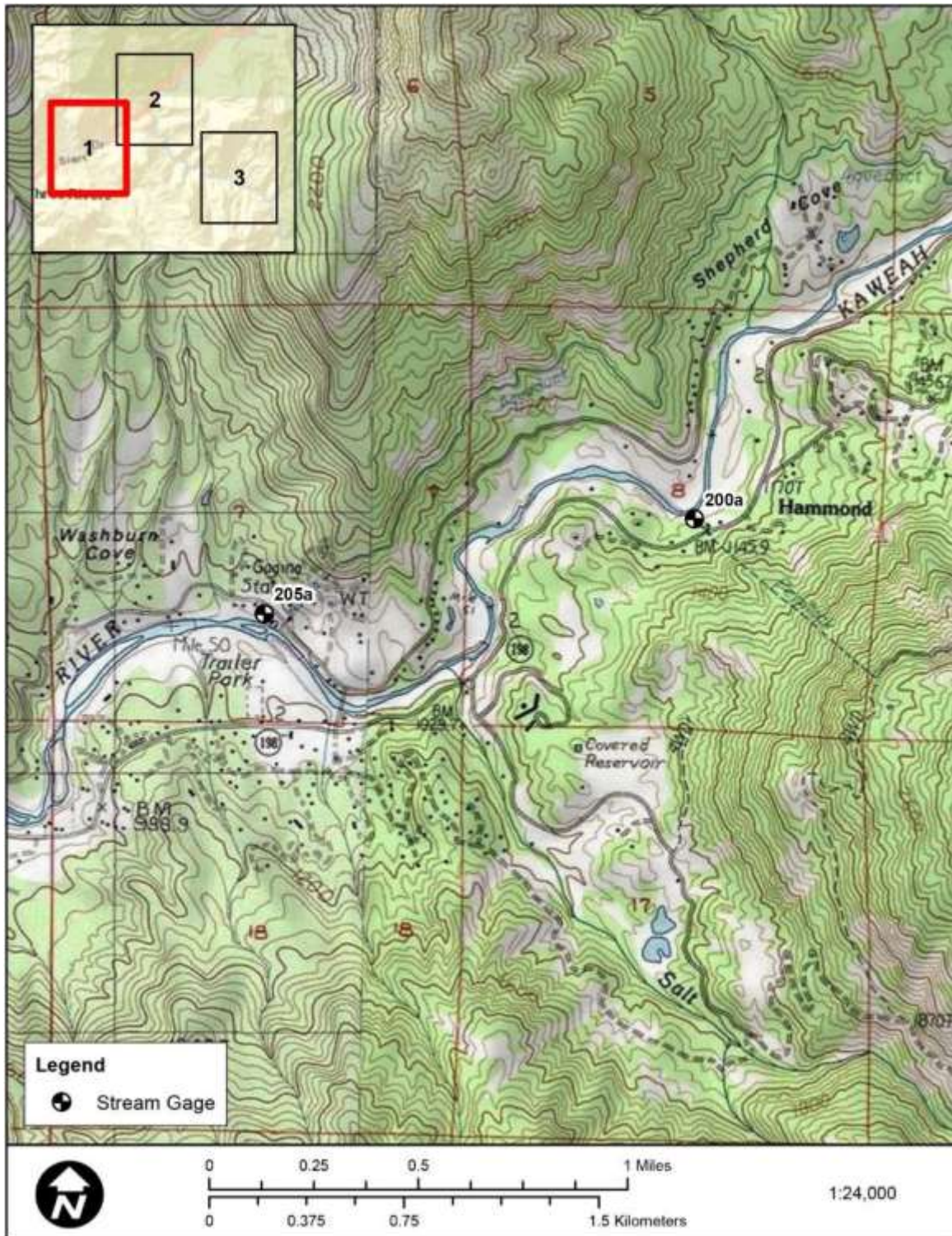

LOCATION MAP

Property Name: Kaweah Hydroelectric Project Stream Gages

Page 193 of 199 Map Name: Case Mountain and Kaweah, CA Scale: 1:24,000 Date of Map: 1986; 1987

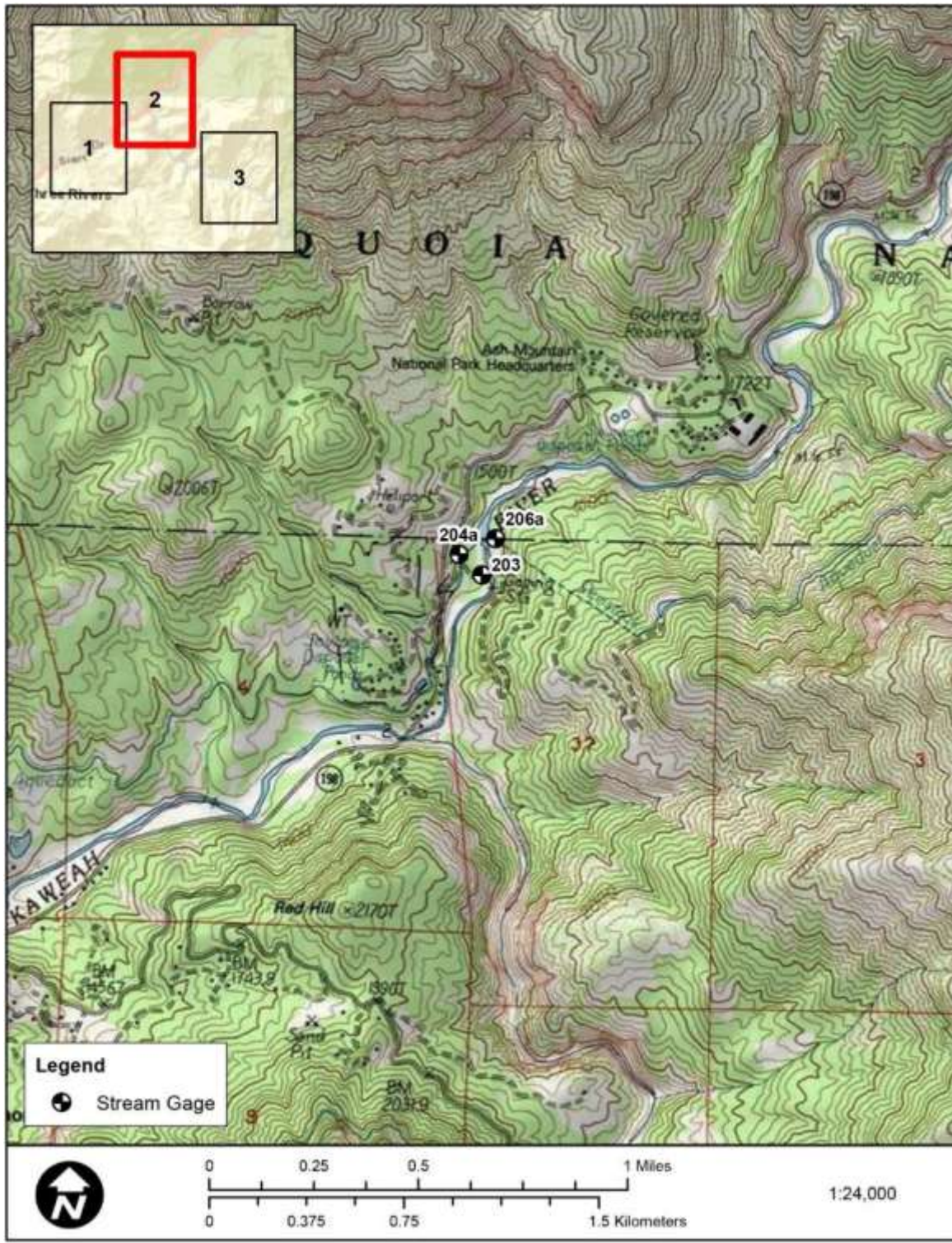

LOCATION MAP

Property Name: Kaweah Hydroelectric Project Stream Gages

Page 194 of 199 Map Name: Case Mountain and Kaweah, CA Scale: 1: 24,000 Date of Map: 1986; 1987

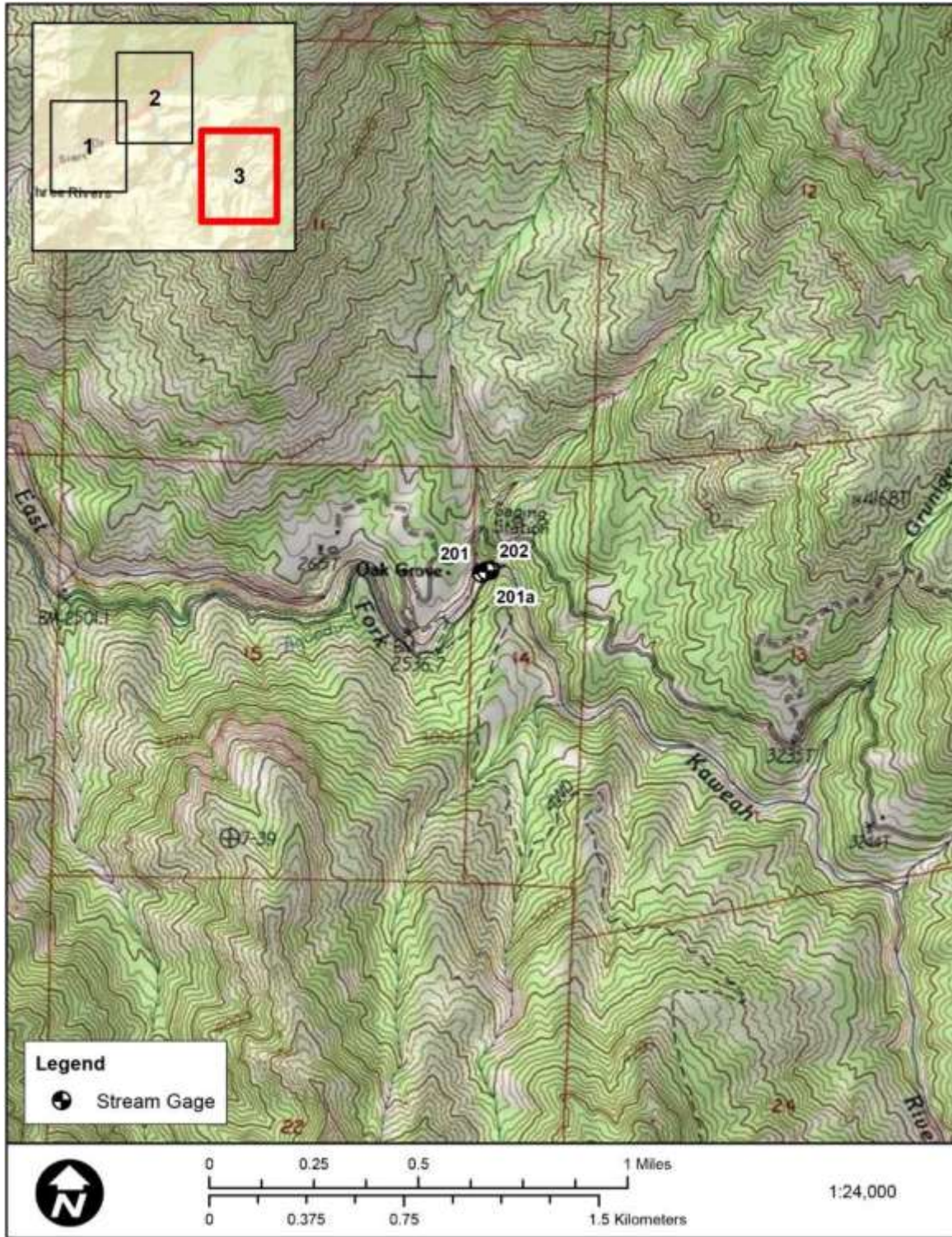

State of California The Resources Agency
DEPARTMENT OF PARKS AND RECREATION
PRIMARY RECORD

Primary # _____
HRI # _____
Trinomial _____
NRHP Status Code _____
Other Listings _____
Review Code _____ Reviewer _____ Date _____

Page 195 of 199 *Resource Name or #: (Assigned by recorder) Kaweah Hydroelectric Project Transmission and Distribution Lines

P1. Other Identifier: _____

*P2. Location: Not for Publication Unrestricted *a. County Tulare and (P2c, P2e, and P2b or P2d. Attach a Location Map as necessary.)

*b. USGS 7.5' Quad Kaweah, Calif. Date 1957 T 16S; R 29E Sec 14; M.D. B.M.

c. Address City Zip

d. UTM: (Give more than one for large and/or linear resources) Zone __, _____ mE/ _____ mN

e. Other Locational Data: (e.g., parcel #, directions to resource, elevation, decimal degrees, etc., as appropriate)

See Location Map

*P3a. Description: (Describe resource and its major elements. Include design, materials, condition, alterations, size, setting, and boundaries)

The Kaweah Hydroelectric Project employs several transmission, distribution, and communication lines to transmit and distribute electricity throughout the Project and out of the Project. The primary transmission line extends approximately 4 miles, extending from the Kaweah No. 3 Powerhouse to the Three Rivers Substation. The primary transmission line connects to the systems switchyards via two short tap lines: a 120-foot long tap line to the Kaweah No. 1 Switchyard and a 0.4-mile long tap line to the Kaweah No. 2 Switchyard. Originally constructed using wood poles, the 66 kV, three-phase, double circuit line now utilizes primarily replacement tubular steel poles and a small number of wood poles with conductors supported by suspension insulators (**Photograph 1**) (see Continuation Sheet).

*P3b. Resource Attributes: (List attributes and codes) HP11 – Engineering structure

*P4. Resources Present: Building Structure Object Site District Element of District Other (Isolates, etc.)

P5a. Photograph or Drawing (Photograph required for buildings, structures, and objects.)



*P5b. Description of Photo: (view, date, accession #) Photograph 1 Kaweah No.3 Transmission Line, camera facing southwest, April 19, 2018.

*P6. Date Constructed/Age and Source: Historic Prehistoric Both
Circa 1950s-2000s (SCE)

*P7. Owner and Address: Southern California Edison
1515 Walnut Grove Avenue
Rosemead, CA 91770

*P8. Recorded by: (Name, affiliation, and address)
Matt Walker and Polly Allen, Cardno, Inc., 2890 Gateway Oaks Dr., Suite 200, Sacramento, CA 95833

*P9. Date Recorded: April 19, 2018

*P10. Survey Type: (Describe) Intensive

*P11. Report Citation: (Cite survey report and other sources, or enter "none.")

CUL-1: Built Environment Technical Study Report, Kaweah Hydroelectric Project, FERC Project No. 298, January 2019

*Attachments: NONE Location Map Continuation Sheet Building, Structure, and Object Record
 Archaeological Record District Record Linear Feature Record Milling Station Record Rock Art Record
 Artifact Record Photograph Record Other (List):

BUILDING, STRUCTURE, AND OBJECT RECORD

*Resource Name or # (Assigned by recorder) Kaweah Hydroelectric Project Transmission and Distribution Lines *NRHP Status Code
Page 196 of 199

B1. Historic Name: Kaweah Project Transmission and Distribution

B2. Common Name: Kaweah Project Transmission and Distribution

B3. Original Use: Electric Transmission and Distribution B4. Present Use: Electric Transmission and Distribution

*B5. Architectural Style: Utilitarian

*B6. Construction History: (Construction date, alterations, and date of alterations) Original Project transmission lines were of wood pole construction. Poles replaced circa 1950s to 2000s with tubular steel poles and some ongoing wood pole replacements.

*B7. Moved? No Yes Unknown Date: _____ Original Location:

*B8. Related Features: Kaweah Hydroelectric Project (see accompanying records)

B9a. Architect: None

b. Builder: Unknown

*B10. Significance: Theme n/a Area n/a Period of Significance n/a Property Type n/a Applicable Criteria n/a
(Discuss importance in terms of historical or architectural context as defined by theme, period, and geographic scope. Also address integrity.)

Kaweah Hydroelectric Project Transmission and Distribution lines do not appear to meet the criteria for listing in the National Register of Historic Places (NRHP) or the California Register of Historical Resources (CRHR) as an individual property or as a contributor to any NRHP or CRHR Historic District. Because the electrical infrastructure is an operational element of the Kaweah Hydroelectric Project, which includes three operationally related hydroelectric systems, the facilities were evaluated for NRHP and CRHR eligibility within the context of the larger operational hydroelectric system. Please see attached District Record for full historic context and evaluation of the infrastructure. Please refer to accompanying Continuation Sheets for full description.

B11. Additional Resource Attributes: (List attributes and codes)

*B12. References: See Footnotes

B13. Remarks:

*B14. Evaluator: Polly Allen and Matt Walker

*Date of Evaluation: December, 2018

This space reserved for official comments.

See Location Map

CONTINUATION SHEET

Property Name: Kaweah Hydroelectric Project Transmission and Distribution Lines
Page 197 of 199

P3a. Description (Continued):

In addition to the primary transmission line, the Project employs local distribution and communication lines to aid in the operation of the Project and communication between facilities (**Photograph 2**). These low voltage lines are carried on wood poles, with some carried on buried fiber, and are of modern and utilitarian construction.

Photographs (Continued):



Photograph 2. Distribution line along Kaweah No. 1 Flowline, camera facing west, April 18, 2018.

LOCATION MAP

Property Name: Kaweah Hydroelectric Project Transmission and Distribution Lines

Page 198 of 199 **Map Name:** Case Mountain and Kaweah, CA **Scale:** 1: 24,000 **Date of Map:** 1986; 1987

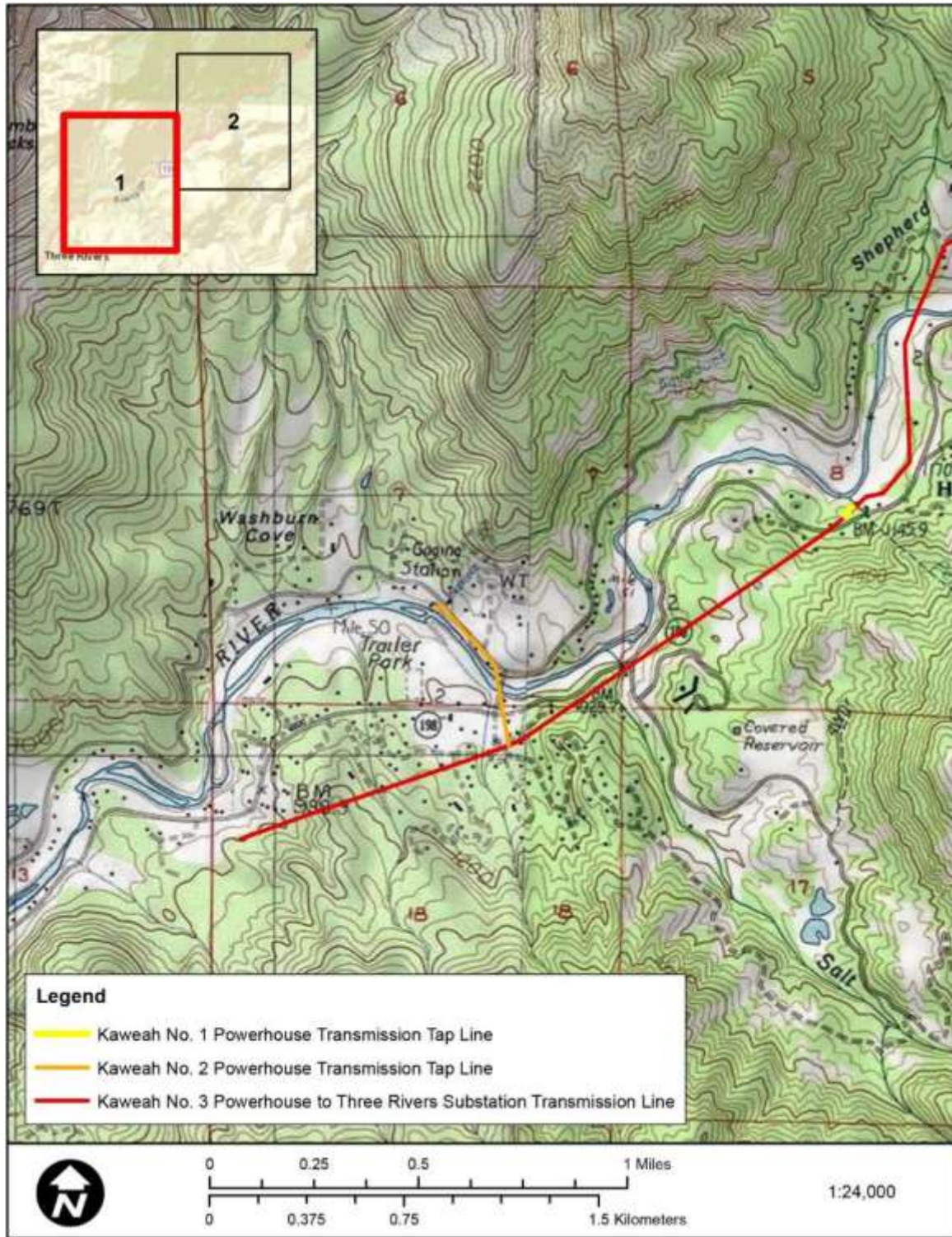

LOCATION MAP

Property Name: Kaweah Hydroelectric Project Transmission and Distribution Lines

Page 199 of 199 **Map Name:** Case Mountain and Kaweah, CA **Scale:** 1: 24,000 **Date of Map:** 1986; 1987

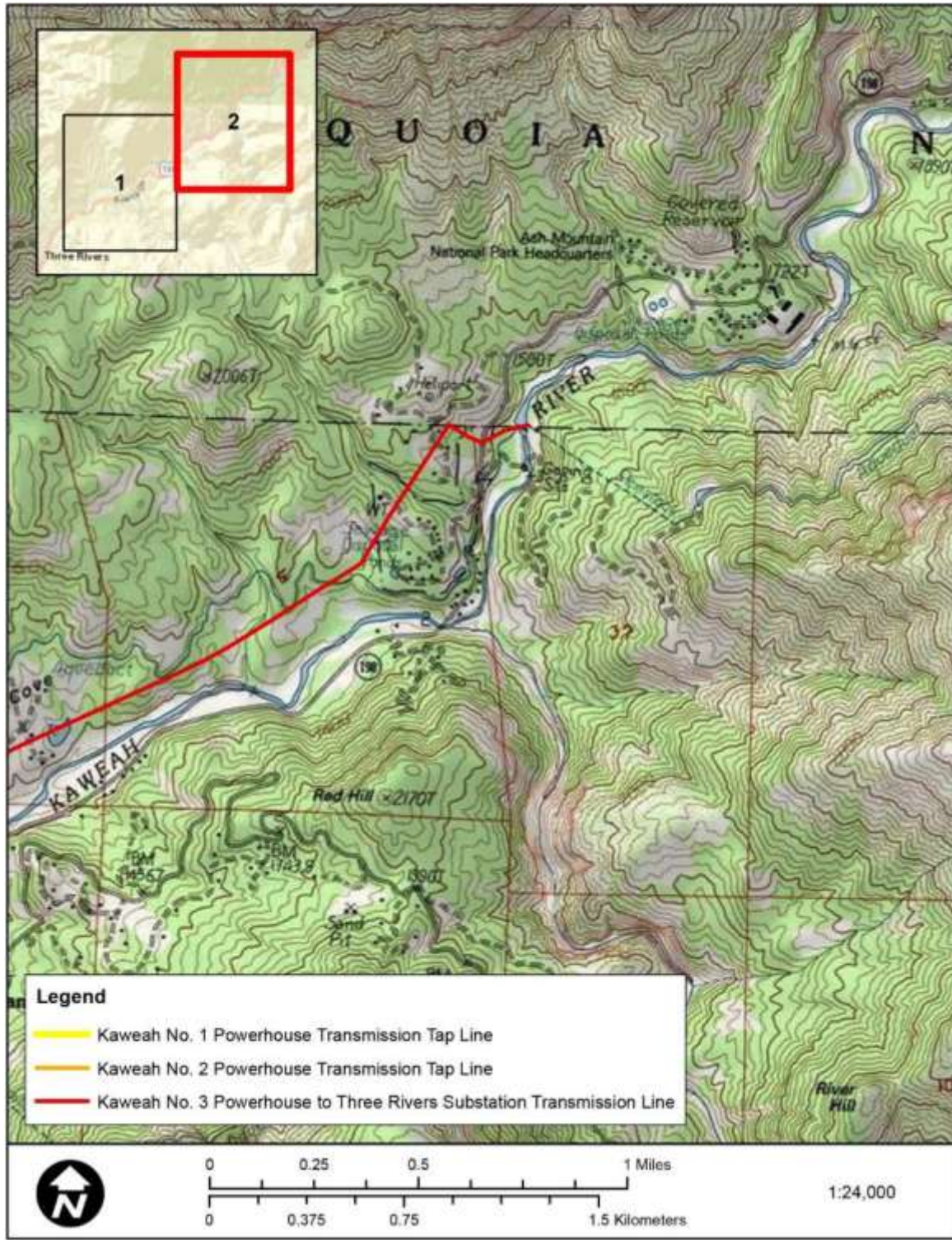

APPENDIX C

History and Significance Evaluation of the Kaweah Hydroelectric System (1989)

This Page Intentionally Left Blank

1160460

**A HISTORY AND SIGNIFICANCE
EVALUATION OF THE
KAWEAH HYDROELECTRIC SYSTEM
TULARE COUNTY, CALIFORNIA**

Prepared by

**Susan C. Lehman
James C. Williams
Robert A. Hicks
Clinton M. Blount**

of

**BioSystems Analysis, Inc.
303 Potrero St., Ste. 29-203
Santa Cruz, California 95060
(408) 425-8755**

Submitted to

**Environmental Affairs Division
Southern California Edison Company
Rosemead, California**

February 1990

TABLE OF CONTENTS

CHAPTER 1 INTRODUCTION	1
Goals and Purposes	1
Location and Description of the System	2
Research Methods	4
Organization of the Report.	5
Project Personnel	6
CHAPTER 2 HISTORY OF THE KAWEAH HYDROELECTRIC SYSTEM	7
Creating the Kaweah Hydroelectric System (1890-1899)	7
Early History of the Mount Whitney Power Company	8
The Construction of Kaweah No. 1 (1898-1899)	10
Expanding the System.	14
Selling Electricity For Agriculture	14
The Mount Whitney Power Company (1899-1905)	16
Expansions of the System - Kaweah No. 2 (1900-1905)	17
Final Developments of the Mount Whitney Power and Electric Company (1905-1920)	19
Mount Whitney Power and Electric Company (1905-1910)	19
Kaweah No. 3 and Sequoia National Park	20
Construction of Kaweah No. 3 (1907-1913)	22
Final Developments and Sale of Mount Whitney Power and Electric Company (1910-1920)	24
Kaweah Under the Southern California Edison Company	27
Administration	27
Maintenance of Kaweah System Under Edison	29
Conclusion	30
CHAPTER 3 RESOURCE INVENTORY AND STATEMENT OF SIGNIFICANCE	32
Kaweah No. 1 Powerhouse and Associated Buildings and Structures	32
Kaweah No. 2 Powerhouse and Associated Buildings and Structures	36
Kaweah No. 3 Powerhouse and Associated Buildings and Structures	38
Eagle, Monarch, Crystal and Franklin Lakes	40
Statement of Significance	40
National Register of Places Eligibility	42
REFERENCES CITED	48

TABLE OF CONTENTS (CONTINUED)

TABLE

Index to Buildings and Structures, Kaweah Hydroelectric System	33
--	----

MAPS

Map 1 Kaweah Hydroelectric System	3
Map 2 Kaweah Powerhouse No. 1 Vicinity	34
Map 3 Kaweah Powerhouse No. 2 Vicinity	37
Map 4 Kaweah Powerhouse No. 4 Vicinity	39

APPENDICES

Appendix A	Historic Resources Kaweah No. 1
Appendix B	Historic Resources Kaweah No. 2
Appendix C	Historic Resources Kaweah No. 3
Appendix D	Eagle, Franklin, Monarch and Crystal Lakes
Appendix E	Project Area Maps

TABLE OF CONTENTS

CHAPTER 1 INTRODUCTION	1
Goals and Purposes	1
Location and Description of the System	2
Research Methods	4
Organization of the Report.	5
Project Personnel	6
CHAPTER 2 HISTORY OF THE KAWEAH HYDROELECTRIC SYSTEM	7
Creating the Kaweah Hydroelectric System (1890-1899)	7
Early History of the Mount Whitney Power Company	8
The Construction of Kaweah No. 1 (1898-1899)	10
Expanding the System.	14
Selling Electricity For Agriculture	14
The Mount Whitney Power Company (1899-1905)	16
Expansions of the System - Kaweah No. 2 (1900-1905)	17
Final Developments of the Mount Whitney Power and Electric Company (1905-1920)	19
Mount Whitney Power and Electric Company (1905-1910)	19
Kaweah No. 3 and Sequoia National Park	20
Construction of Kaweah No. 3 (1907-1913)	22
Final Developments and Sale of Mount Whitney Power and Electric Company (1910-1920)	24
Kaweah Under the Southern California Edison Company	27
Administration	27
Maintenance of Kaweah System Under Edison	29
Conclusion	30
CHAPTER 3 RESOURCE INVENTORY AND STATEMENT OF SIGNIFICANCE	32
Kaweah No. 1 Powerhouse and Associated Buildings and Structures	32
Kaweah No. 2 Powerhouse and Associated Buildings and Structures	36
Kaweah No. 3 Powerhouse and Associated Buildings and Structures	38
Eagle, Monarch, Crystal and Franklin Lakes	40
Statement of Significance	40
National Register of Places Eligibility	42
REFERENCES CITED	48

TABLE OF CONTENTS (CONTINUED)

TABLE

Index to Buildings and Structures, Kaweah Hydroelectric System	33
--	----

MAPS

Map 1 Kaweah Hydroelectric System	3
Map 2 Kaweah Powerhouse No. 1 Vicinity	34
Map 3 Kaweah Powerhouse No. 2 Vicinity	37
Map 4 Kaweah Powerhouse No. 4 Vicinity	39

APPENDICES

Appendix A	Historic Resources Kaweah No. 1
Appendix B	Historic Resources Kaweah No. 2
Appendix C	Historic Resources Kaweah No. 3
Appendix D	Eagle, Franklin, Monarch and Crystal Lakes
Appendix E	Project Area Maps

CHAPTER 1

INTRODUCTION

Southern California Edison Company's Kaweah Hydroelectric System is located on the Kaweah River drainage in eastern Tulare County in the southern Sierra Nevada of California. The system, which consists of reservoirs, diversions, flumes, penstocks and three powerhouses, was constructed, beginning in 1898, over the first two decades of this century by the Mount Whitney Power Company. In 1920 the Kaweah project became part of the growing Southern California Edison (SCE) electric generation and transmission system and has been maintained and operated since that time by SCE.

As part of its responsibilities under relicensing regulations, SCE is now providing various environmental inventories and assessments of the Kaweah Hydroelectric System to the Federal Energy Regulatory Commission (FERC). A major component of this effort is the evaluation of the ongoing effects of the system on significant cultural resources. The generation facilities themselves, by virtue of age and their place in the development of hydroelectric generation in California and the west, may be of historical significance. Thus SCE engaged BioSystems Analysis, Inc. Cultural Resources Division (BioSystems) to investigate the historical background of the Kaweah System and to provide an assessment of its historical significance, with reference to the criteria for inclusion on the National Register of Historic Places. The historical overview, inventory of historic features and analysis of historical significance of the system will be used by reviewers, particularly the California State Office of Historic Preservation as they consider the Kaweah Hydroelectric Project relative to FERC's relicensing regulations.

Goals and Purposes

The primary focus of the historical research has been to provide SCE with data and analyses sufficient to address the FERC regulatory requirements. To achieve this basic

goal, BioSystems has engaged in a number of research tasks which may be broken down as follows:

1. Prepare a thorough historical overview of the Kaweah System, which addresses the topics of design and construction, corporate history, changes in the system, and patterns of operation and maintenance;
2. Conduct a field inventory and evaluation of all potentially significant historic structures and buildings associated with the system; and
3. Prepare an evaluation of the features of the system which addresses the criteria for inclusion on the National Register of Historic Places, including themes and periods of historical significance and integrity of the resources.

Location and Description of the System

The Kaweah Hydroelectric System is located in rural eastern Tulare County. The core of the system, Powerhouses Nos. 1, 2 and 3 are located in the vicinity of the community of Three Rivers, approximately 5 to 15 miles upstream on the Kaweah River from the Lake Kaweah Reservoir (see Map 1, The Kaweah Hydroelectric System).

Powerhouse No. 1 uses water from the East Fork of the Kaweah River. Flows in the river, upstream from the intake are maintained by 4 small reservoirs located in the high altitude Mineral King area east of the powerhouse. These lakes, Eagle, Franklin, Crystal and Monarch, discharge water into the natural river bed. Well downstream, this water is diverted from the river into a flume and finally a penstock for delivery to the powerhouse. Powerhouse No. 3 operates with water from the Marble and Middle forks of the Kaweah and Powerhouse No. 2 is operated on water diverted from the Kaweah at a point just downstream from Powerhouse No. 3. Thus the Kaweah System may be divided, for purposes of description, into three loci, each a distinct hydroelectric generation facility represented by one of the three powerhouses.

MAP 1. Kaweah Hydroelectric System

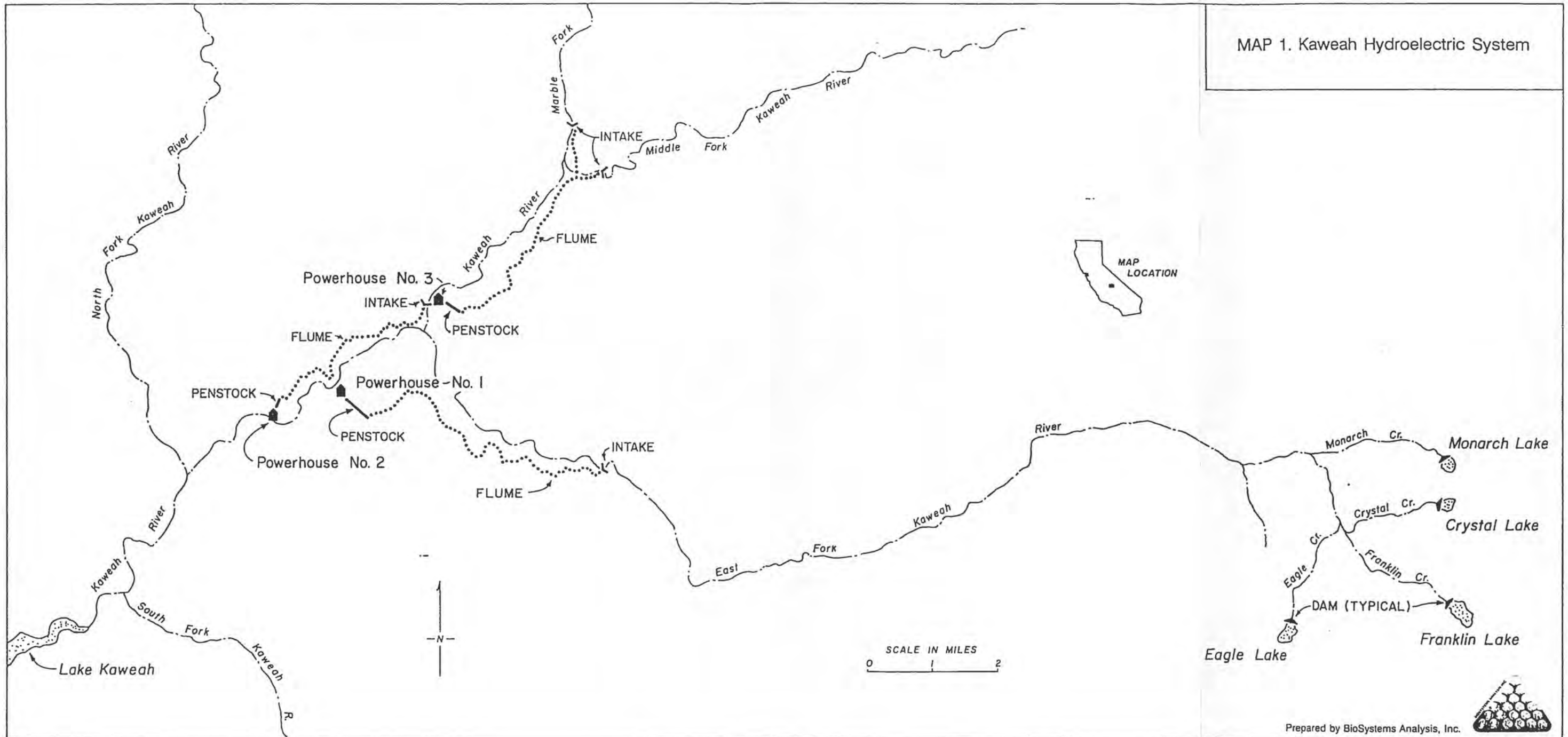

The present configuration of the Kaweah System is much the same as when it was designed and constructed. The hydroelectric production of the System is not great, relative to SCE's larger systems (ie. Big Creek, to the north) and modifications to the production facilities have been very limited. Of note are the movement of the location of Powerhouse No. 1 in 1928-1929 and the gradual replacement of many portions of the original flowlines. Some changes in the generation and transmission facilities have also occurred, particularly the automation of portions of the powerhouses to allow remote monitoring and operation. Partial automation of the powerhouses has also resulted in a much decreased need for an on-site work force, thus many of the residential and support function buildings and structures surrounding the powerhouses have been removed. These changes notwithstanding, the basic hydroelectric production elements of the system are largely unchanged from the time they were first in service.

Research Methods

BioSystems researchers designed and followed a phased approach to the evaluation of the Kaweah Hydroelectric System. Phase 1 research consisted of a thorough review of documents in the major California historical libraries and archives. The purpose of this review was to document the design and construction of the Kaweah System as reported in the technical journals, government reports and similar sources, from the period of the development of the system. These data not only provide details of the events surrounding design and construction, but also the views of the engineering community and power industry concerning the developing system. Major repositories visited were: the National Archives Records Center, San Bruno, California; The Bancroft Library, Berkeley; the California History Center, Cupertino; and, the Tulare County Library. A very important source of information during this early phase of work was the body of material retrieved by SCE from its own extensive archives. These background historical data were used to prepare a working chronology for the Kaweah System.

Phase 2 consisted of an archival search conducted in the project vicinity. This search concentrated on the archives maintained at Kaweah Powerhouse No. 1 and the extensive files (related primarily to Kaweah No. 3) at the Sequoia National Park headquarters. The materials at Powerhouse No. 1 (the administrative headquarters for the Kaweah System) consisted of correspondence, plans and maps, historic photographs, and importantly, records of maintenance, modification and day-to-day operation of the system. This local records search also allowed researchers to discuss the system with SCE employees who proved to be an invaluable source of information, particularly on the subject of recent maintenance activities.

Phase 3, the final work task was a complete field inventory of the system. Researchers visited all system facilities with the exception of the high altitude lakes. At each facility, data were gathered for a number of purposes including preparation of California Department of Recreation historical inventory forms (Form DPR 523) and the assessment of potential NRHP eligibility. Architectural details were noted, records of date of construction and modification were field checked and generation equipment was carefully examined. Portions of the DPR 523 forms were completed in the field, as were field maps of the buildings and structures at each of the facilities.

Organization of the Report

This historical evaluation of the Kaweah Hydroelectric System contains three elements. Chapter 2 provides a historical narrative which focuses on the origin of the system, periods of development and operation and the history of the significant individuals and corporations associated with the project. Chapter 3 comprises an inventory of the historical features of the system as well as an evaluation of these features with regard to criteria for inclusion on the NRHP. Finally, a detailed inventory of historical buildings and structures is provided in appendices A-D (Powerhouses No.1 through 3 and the four remote reservoirs).

Project Personnel

This research was completed by several BioSystems team members. Historian Susan Lehmann took the lead in preparing the historical overview as well guiding the archival research at both large repositories and in the document files at Kaweah No. 1 and Sequoia National Park. Historian James Williams participated in the field evaluation, prepared the draft DPR 523 forms and the evaluation of significance. Researcher Robert Hicks participated in the archival research and field inventory, prepared significant portions of the resource inventory, photographed the resources and prepared the maps in the text. Clinton Blount acted as project manager, prepared portions of the text and edited the draft document.

CHAPTER 2

HISTORY OF THE KAWEAH HYDROELECTRIC SYSTEM

Creating the Kaweah Hydroelectric System (1890-1899)

Unlike the numerous power systems developed in California during the early years of the twentieth century, the Kaweah hydroelectric project had a singular and unique purpose. Other companies throughout the state struggled through their first years of development by trying to convince a skeptical public of the advantages of electric products from lights to curling irons. When attempts to lure subscribers were not sufficient to provide adequate cash flow, many companies were forced to go out of business or to curtail plans for needed development. The early backers of a plan to develop the Kaweah River as a power source, however, believed they had a ready made constituency. Their plan was to sell electrical power to the burgeoning farming industry of Tulare County expressly for the purpose of irrigation.

The use of irrigation to produce crops had developed early in Tulare County. The first white settlers came to the area in 1852, made their homes along the Kaweah River east of present day Visalia and raised cattle (Small 1926: 286). Ditches were built almost immediately to deliver river water to the stock and in 1854 Dr. Reuben Matthews of Visalia cut a ditch to both run his mill and irrigate his gardens. In the next forty years various water associations and ditch companies were formed but fierce and lengthy water rights litigation battles prevented large scale projects from being developed (Menefee and Dodge 1913: 132). With the passage of California's Wright Act in 1887, agricultural communities in the state were given the opportunity to form irrigation districts that could sell bonds, tax property, condemn individual water rights and build more extensive projects that had been possible previously (Worster 1985: 108-109). The act enabled the formation of the Tulare District Company, the Kaweah River Water Association and the St. John River Water Association. Although these groups vied for the same water supply, they

eventually were able to agree on an equitable division of river flow (Menefee and Dodge 1913: 132). In spite of a number of ambitious irrigation projects built by these companies, the essential problem of low water during the season when irrigation was most needed remained. As a result, wheat and other dry land crops continued to be the staples for the area and it appeared doubtful that any crops requiring more than 10 inches of rain per year would ever be raised on the million or so acres not directly served by these projects.

In 1890, an enterprising farmer, Capt. A.J. Hutchinson, planted 100 orange trees in Lindsay and by 1894, 284 acres of the trees had been planted. With Kaweah River water already appropriated elsewhere, he irrigated his land by digging wells. The pumps necessary to draw from the wells were operated by gasoline and proved to be noisy, in need of constant tending and very expensive to operate. In spite of an extensive underground water supply, planting of citrus and deciduous fruit tree on the scale attempted by Hutchinson was limited by the inadequate pumping methods that existed.

Realizing the problem and eager to provide a solution, Visalia newspaper publisher Ben Maddox, and Albert Wishon, a real estate and insurance entrepreneur were instrumental in the formation and promotion of what would become the Mount Whitney Power Company. Backed by funds obtained through the efforts of Wishon's real estate partner, William Hammond, the group launched an enterprise that substantially changed not only the type of farming practiced but the entire economy of the area (Williams 1984: 183-189; Menefee and Dodge 1913: 131-134).

Early History of the Mount Whitney Power Company

In writing the history of the Mt. Whitney Power and Electric Company, Ben Maddox explained his involvement in the project. According to Maddox, managers of the Visalia Gas, Light and Heat company announced in July 1891 that to make ends meet they would have to curtail power services and, if more subscriptions were not forthcoming, the entire

enterprise would go out of business. Maddox used the opportunity to editorialize in the *Visalia Times* that the solution to the area's long term needs lay in the use of "the magnificent water power on the Kaweah River" This untapped resource, he said, could be used to generate "electricity for light as well as for power for every manufacturing establishment now in existence here or that may be started within the next generation" (Maddox 1914). A later visit to A.J. Hutchinson's farm in Lindsay further encouraged Maddox to believe that electric power could change the entire face of the county. In a series of editorials, Maddox observed that Hutchinson had transformed what had formerly been wheat fields into a "veritable garden spot" with oranges, lemons, olives and grapes. To sustain this miracle, Hutchinson had purchased a six horse power gasoline engine capable of pumping 15,000 gallons of water per hour. If this could be done with a single gasoline powered engine, Maddox reasoned, electrically powered machines could virtually transform agriculture. The construction of a power plant along the Kaweah River, Maddox wrote, could "make our orchards prolific, run our cars, drive our machinery, lighten our darkness and make thousands of people comfortable and happy" (Maddox 1914: 3).

Turning his idea into reality required the participation of other local entrepreneurs. A.G. Wishon of Tulare was an early enthusiast of developing the potential of both irrigation and electricity. He formed the Kaweah Power and Water Company in 1895 for the purpose of bringing power to Visalia but lost financial backing for the enterprise when his plans were deemed by investors to be too ambitious. Undaunted, he continued to pursue the idea, this time in partnership with real estate developer William Hammond. The two made preliminary surveys of river flow and began proceedings to obtain rights of way and water appropriations necessary to create an entity they had already christened the Mount Whitney Power Company (Maddox 1914: 4). Since obtaining local financing proved to be impossible, Hammond, joined by Maddox, attempted to interest San Francisco and Oakland investors. With other ventures proving to be less speculative and much more

lucrative than providing power to Tulare County farmers, the two were repeatedly turned down and the enterprise appeared doomed.

Before completely abandoning the project, Hammond suggested as a last resort that he travel to London and speak to his brother. John Hayes Hammond, a mining engineer, had made a considerable fortune in gold mining ventures and, after hearing the plans, agreed to finance half of the project. His friend, Leopold Hirsch agreed to provide funds for the other half (Maddox 1914: 4-5; Williams 1984: 183). Hammond returned to Visalia in September of 1898 with the promise of a \$200,000 initial investment, \$50,000 of which had already been deposited in a San Francisco bank. The group decided initially to remain unincorporated in order to avoid the inconvenience of having to contact the board of directors in London to obtain approval for day to day operations. Instead they formed a partnership between W.H. Hammond and A.G. Wishon with Wishon authorized to act as agent. On December 26, 1899, soon after the first power plant went into operation, articles of incorporation were filed and the Mount Whitney Power Company became a California corporation (Maddox 1914: 5-6; Fowler 1923: 555).

The Construction of Kaweah No. 1 (1898-1899)

Most of the appropriate water rights and rights of way had been obtained prior to financing of the project. Although A.G. Wishon and Kaweah Power and Water Company had posted notices for appropriations at various points along the river as early as 1894, they were lost because of the fact they had never been used. On December 11, 1897, William Hammond posted notices in essentially the same locations to appropriate 1000 miner's inches under a 4 inch pressure at the "east fork of the Kaweah River in Section 14 or 15, T. 17, R. 29 E, M.D.B. and M. and near Cains Flat" for the purpose of generating power (SCE Vault Document No. 20063 in W.E. Bergh 1950: 2). In addition, rights of way for the flume were obtained from landowners along the route. As part of the agreement granting these rights, landowners were permitted to divert an agreed upon

amount of water from the proposed flume for their own use. The control of the point of diversion rested with the power company and the expense of building and maintaining these diversions were generally shared by the owners and the company (SCE 1950: Vault Document No. 20131 and No. 20156).

The partnership chose engineer Robert McF. Doble to design the power plant and the hydraulic system. His plans called for locating the head on the East Fork of the Kaweah River at an elevation of 2,600 feet. Building a plant with a head of 1,300 feet was considered "almost a pioneer effort in the history of long distance transmission" since only one or two plants had previously attempted to operate under so high a head (Van Norden 1913: 5). The place chosen was a natural dam formed in the rock by stream erosion. From a small pool above the dam, the water was taken through a tunnel 3 feet wide, 6 feet high and 50 feet long that had to be blasted through solid granite. At the lower end of this tunnel the flume began (Doble 1900: 6; Fowler 1923: 663).

Constructing the flume provided a formidable problem due to the remoteness and ruggedness of the terrain. The first step involved leasing the Atwell sawmill located on the East Fork of the Kaweah River about 14 miles above the head. The mill began immediately producing the 762,000 board feet of lumber necessary to complete the flume. An ingenious system was developed to bring the boards to the construction site. After the finished lumber was delivered by teams and wagons to a point near where the flume was to begin, the next step was to transport it across the river to the flume grade some 300 feet below. In order to accomplish this feat a "v" shaped dry chute was built in sections. The bottom of the flume box completed first and lumber was moved along the finished bottom by dollies to the area where the carpenters were working. When the sides were completed and could hold water the flume was temporarily flooded and lumber was floated the next section where the process began again. Because of the ruggedness of the terrain heavy blasting was necessary to provide a grade for the flume and iron pins had to be set into rock to make footings for the posts (Doble 1900: 8).

The flume was constructed of solid redwood and when complete was 30,723 feet long. The box was 3 feet wide and 2 feet deep built of 1 1/2 by 12 inch planks battened by 1 by 4 inch strips. The box was supported by 4x4 inch timbers and in many places trestles were required to cross ravines and other parts of the terrain. Although the supporting framework caused considerable trouble and had to be rebuilt over time, the box itself lasted nearly 50 years until it was replaced in 1947 by a metal flume (Fowler 1923: 663; Myers 1983: 91). Sand boxes and waste gates were built at intervals along the flume to collect debris and the flume terminated in a sand box and overflow gate. Built at right angles to these was a nine foot wide apron spillway that led to the penstock. Gates at the entrance to the apron regulated the amount of water into the pipe and iron racks with wire screens served to prevent any foreign matter from entering the system.

To provide communication between the flume tender and the powerhouse a telephone line was installed along the entire length of the flume. In addition, storehouses were built about a mile apart on the line each containing a telephone, supplies and tools necessary to repair leaks or breaks in the flume. The flume tender's house was located at the penstock and from this perch he could look almost directly down to the powerhouse and river some 1,300 feet below (Doble 1900: 8).

Constructing the pipeline was almost as difficult as building the flume. Laid in a single line approximately 3,300 feet long, the pipe was buried in a deep trench for most of the way. Excavating this trench required blasting into solid granite and in at least one place the rocks had to be cut 20 feet deep. Starting at the penstock the pipe was 50 inches in diameter tapering down to 24 inches in the first 50 feet. Following that was 2,110 feet of riveted and 1,160 feet of welded pipe (Fowler 1923: 663; Doble 1900: 9).

Laying the pipe required that it be moved from the bottom of the hill and lowered into the ditch at the proper place then riveted together. This was especially difficult since the

hillside stood at a 45 degree angle in many places. The ground was so uneven that more than 70 angle pieces had to be made to make the pipeline conform to the profile of the ditch. Doble described the process:

The pipe was hoisted to place by means of an overhead cable stretched from the bottom of the hill to the top, being carried on trolleys suspended from the cable and moved by means of a draw line and hoisting engine. In some places the pipe would be in the air over 60 feet on its upward journey, giving it the appearance of flying to its destination. As each joint was laid it was carefully riveted, then the earth was very thoroughly tamped, with water, under and over the pipe so as to give it a perfect and solid bearing in the ditch, and then it was completely covered. At some places where the ground was favorable several pieces were riveted together before lowering into the ditch (Doble 1900: 10).

For the first 400 feet from the powerhouse the pipe was laid in concrete and at the points where the rock was unusually steep, it was fastened to the granite bed rock with iron bands (Fowler 1923: 663-664). Three outlets entered the powerhouse with a fourth outlet serving as a wasteway. The pressure registered at the nozzle in the powerhouse was 565 pounds per square inch, a force which Doble found remarkable. It was hard to imagine its tremendous power, he wrote. "A faint idea may be obtained by watching the water issuing from the waste nozzle in a stream as solid as a bar of iron, traveling at a velocity of over 17,000 feet per minute, and continuing straight across the river with such a force as to strip the branches off of the trees on the opposite bank" (Doble 1900: 11).

The powerhouse itself was described as a "plain but substantial structure." 30 by 50 feet and 20 feet high at the eaves and resting on a concrete foundation, it was constructed of Oregon pine covered with corrugated iron (Doble 1900: 11; Fowler 1923: 664). The original powerhouse equipment contained the following: three Doble tangential water wheels 44 inches in diameter with a maximum capacity of 1000 horsepower; three Westinghouse Kodak type three phase alternating generators and four Westinghouse oil

insulated air cooled transformers with a normal capacity of 500 kilowatts each (Doble 1900: 16).

Considering the physical difficulties of constructing the system, it was completed in a relatively short time. Actual construction began on October 1, 1898 and on June 29, 1899 the *Visalia Times* reported: "the long distance electric plant [which] begins today to furnish the power that will make the wheels of manufacturing establishments turn, irrigating plants multiply and darkness light" (Maddox 1914: 7). Although the investors, engineers and booster Maddox had been successful in turning their plan for hydroelectric power from the Kaweah into reality, the work of convincing local residents to buy the electricity was just beginning.

Expanding the System (1899-1905)

Selling Electricity For Agriculture

When the first motor was cut in on the Lindsay Substation in June 1899, it was fitting that it should be connected to a pump to be used for irrigation. Skepticism that such an idea could ever work was reflected in the amazement of the spectators when the motor was started "with no noise, no smoke and no engineer." Watching the water flow at the flick of a switch, one startled spectator observed, "By God, it does do it, don't it" (Maddox 1914: 9).

In spite of this miracle, signing up individual subscribers was not an easy task. Few houses in the area were wired because of the high rate that had been previously charged for current. In addition, farmers remained unconvinced that real power could be delivered over wires and that it was reliable enough to give consistently good service. The first customers of the company were primarily commercial users such as the ice plant, the local newspapers, the water works and the Pioneer Hotel in Porterville (Los Tulares 1980: 2; Maddox 1914: 9).

A.G. Wishon, however, was determined to pursue his belief that electrical pumping was a viable idea. When all else failed, he borrowed \$25,000, bought electric motors himself and offered them to farmers on credit. With no down payment and five annual installments at six percent interest, the proposition was too good to turn down. Farmers signed up for all the pumps he could deliver and irrigation made possible by electricity was on its way in Tulare county (Williams 1984: 184; Maddox 1914: 19).

In setting up the rate structure for the Mount Whitney Power Company, the irrigation customer was kept firmly in mind. The previous power company, Visalia Gas, Light and Heat, had charged by the month at a rate of 50 cents per month for each lamp used in residences. Commercial rates were even more expensive, with stores using their light until midnight paying \$1.50 per month for each light. While Mount Whitney's rates to residential and commercial customers was essentially the same, Wishon argued successfully that charging a flat fee of \$50.00 per horsepower per year for those using pumps would be advantageous to both the company and the consumer. Such a system would give the company "a guaranteed income for every horsepower operated and at the same time would give to the consumer a fixed and firm obligation for his yearly power expenditure." To further encourage business, the company offered to light the house of the consumer at no additional expense when the pump was not in use. The company assured that there would be no cheating on this arrangement by installing a switch that made it impossible to operate both systems at the same time (Maddox 1914: 18-20).

Tailoring the rate structure to encourage the use of electricity for irrigation paid off for both the company and ultimately for the economy of the area served. After a slow start, the number of consumers increased dramatically. In 1903, there were only 710 subscribers. By the time the company was absorbed by Southern California Edison in 1920, the number had climbed to nearly 13,000. Even more remarkable was the percentage of power used for pumping. In hearings before the Railroad Commission in

1916, the management of the company reported that over 86 percent of all the electrical energy sold was used in connection with agriculture (Fowler 1923: 583-586).

The Mount Whitney Power Company (1899-1905)

Articles of incorporation for the Mount Whitney Power Company were filed in Tulare County on December 22, 1899 with capital stock of \$300,000. At the first meeting of the stockholders on January 24, 1900, a board of directors was elected consisting of William H. Hammond, A.G. Wishon, R.P. Hammond, Ben Maddox and Susan Mitchell (Mount Whitney Power Company 1900-1904: Minutes, Jan. 24, 1900). Two months later, Hammond and Wishon turned over their interest in the company and its real property and in exchange were issued stock of 23,244 and 1,744 shares respectively (Mount Whitney Power Company 1900-1904: Minutes, March 5, 1901).

In 1902, a falling out occurred between Wishon and principal stockholder John Hammond. Ambitious and enthusiastic about the future growth of the power industry, Wishon urged that extensive development be made as soon as possible on the San Joaquin, Kings, Kaweah, Tule and Kern Rivers. Hammond, on the other hand, considered his primary business to be mining development. Although willing to continue making modest investments, he had no intention of providing the resources necessary to finance Wishon's extensive plans. As a result, Wishon left the company and moved to Fresno and, with new partners, set about developing the San Joaquin Light and Power Corporation. His determination to create a formidable rival to Hammond's company was, in later years, to prevent Mount Whitney from becoming the major electric utility in the Southern San Joaquin Valley (Myers 1983: 95-96).

Wishon's defection had little immediate effect on the company, however, as the directors undertook more modest expansion and development. On December 1, 1902, the company purchased the Porterville Light and Power Company for the sum of \$4350.25 and made

plans to construct at least one additional powerhouse, as well as more flumes, pipelines and substations. To finance this expansion the board of directors voted on March 19, 1903 to increase the capital stock from 300,000 to 1,000,000 shares (Mount Whitney Power Company 1900-1904: Minutes, March 19, 1903). In 1904, Mount Whitney purchased the capital stock of the Globe Light and Power Company which had been formed to build a power plant on the Tule River. Operating essentially as a subsidiary of Mount Whitney, Globe Light and Power completed the Tule River project in 1909 (Maddox 1914: 12).

By the end of 1905, the Mount Whitney Power Company showed a healthy, if unspectacular, rate of growth and profit. Out of gross earnings of \$67,137.13, the company posted a profit of \$37,249.57 and issued stock dividends of \$.16 $\frac{2}{3}$ a share (Mount Whitney Power Company 1904-1907: Minutes, December 4, 1906).

Expansion of the System - Kaweah No. 2 (1900-1905)

In laying out plans for the original system, engineers had recognized the advantage of using the Mineral King Lakes, located above the East Fork of the Kaweah River, as storage reservoirs. Permission to construct reservoirs at these sites was granted by the Department of the Interior on September 25, 1900. Construction began later that year on dams across the outlets of Upper Monarch, Lower Monarch, Silver (now Crystal), Lady Franklin and Eagle Lakes. The reservoir at Silver (Crystal) Lake was completed in 1903; Eagle Lake in 1904 with Upper Monarch and Lady Franklin following in 1905. Lower Monarch Reservoir was abandoned when it was decided that the lake site was too small (SCE, 1950: 107).

A legal challenge by the Lakeside Ditch Company later arose concerning the use of the water in these lakes by the power company. The matter was settled in January 1909, however, when the Superior Court of Tulare County ruled that the Mount Whitney Power Company had a right to regulate the flow from the lakes as well as to maintain diversion

dams on the East and Middle Forks of the Kaweah River providing the water was returned to the Kaweah River above the head of the Wutchumna Ditch. In addition, the gates at the dams were not to be closed earlier than September 1st nor later than December 1st. A further provision held that no other waters that would flow into the Kaweah River could be impounded by the Company when there were less than 2400 c.f.s flowing in the River one mile above the head of the Wutchumna Ditch. Although the decision was favorable to the company, this provision would later prevent Mount Whitney from completing expansion plans that included a reservoir on Wolverton Creek (SCE, 1950: Vault Doc. 82557).

Construction began on Kaweah No. 2 in 1904 and was completed the following year. The diversion was located in the Middle Fork approximately one mile above the junction with the East Fork. A natural dam provided the site for the diversion where a low granite masonry dam with a maximum height of 8 feet was constructed. Four hand operated sluice gates were built at the intake for the canal which in turn followed the hillside for approximately four miles. Most of the canal ran through a concrete lined ditch, however, several sections of timber flume 5 feet wide and 4 feet deep also were constructed over ravines and uneven ground. The canal line ended in a small forebay 270 feet long, 12 feet wide and 9 feet deep. Five sliding gates allowed the water to pass into the head of the pressure pipeline (Van Norden 1913: 8).

The pipeline was 1,000 feet long with a pipe diameter of 40 inches. On reaching the powerhouse, the pipe was divided into three branches to supply water to the three generating units installed in the plant.

Powerhouse No. 2, completed in 1905, was built about a mile below Kaweah No. 1. It was constructed in the same style as powerhouse No. 1, a corrugated iron building 59 1/2 feet long and 32 1/2 feet wide. John Coffee Hays, an executive of the company, did not

consider the building to be permanent although ironically, the building is still in use. Hays described the building as adequate for keeping the rain off, but hot in summer, cold in winter and not strictly fireproof (Hays 1910: 748). The powerhouse originally contained three main generating units, each with a capacity of 500 kw. These were connected to high-head Victor Girard type turbines regulated by Lombard governors. Two turbine-driven exciters were installed which were hand regulated (Hays 1910: 748). Adjoining the powerhouse a long concrete building was constructed to house seven Stanley G.I. 350 kw oil insulated raising transformers. Mounted on low, structural steel cars, the transformers could be rolled out of the building on transfer trucks and into the powerhouse on tracks to be repaired in necessary. The building was divided into sections by walls so that each transformer occupied a cell of its own. Oil from the transformers was cooled by circulating it through a coil of 2 in. pipes which were mounted in the tail race (Van Norden 1913: 7-8).

During the initial years of Mount Whitney's operation, the system depended entirely on its hydraulic stations. In anticipation of increased load, the necessity of providing power in an emergency and the possibility of long periods of low water, a backup steam plant also was planned. Work began on the Visalia steam station in 1905 and the plant was completed in 1906.

Final Developments of the Mount Whitney Power and Electric Company (1905-1920)

Mount Whitney Power and Electric Company (1905-1910)

In early 1906, John Hays Hammond suggested to his brother that perhaps the time had come to sell the Mount Whitney Power Company. William Hammond had little trouble finding a buyer but immediately before proceeding with the sale, he began having second thoughts and wrote to his brother that perhaps they should reconsider. Taking into account the amount already invested and outstanding loans and bonds, William Hammond

concluded that the sale of the company would bring about \$500,000. After reviewing the company's assets and potential for expansion, he concluded that the company might be worth a great deal more (SCE Kaweah No. 1: 1906). Considering the options, the brothers decided to keep the company and proceed with their development plans. These included the building of additional powerhouses and required negotiations with the Department of the Interior in order to locate part of the system within Sequoia National Park.

William Hammond died in February 1908, however, John Hammond continued as principal stockholder in the company. On November 8, 1909, the company reorganized in order to secure more extensive financing. Taking the name Mount Whitney Power and Electric Company it issued \$1.8 million in preferred stock, \$3.2 million in common stock and authorized a bonded indebtedness of \$5 million (Mount Whitney Power and Electric Company 1909-1922: Aug. 9, 1910; Maddox 1914: 14).

Kaweah No. 3 and Sequoia National Park

The company had anticipated the necessity of establishing water rights for a third plant as early as 1902 and in that year posted notices on the Marble Fork of the Kaweah directly below Marble Falls and on the Middle Fork "about two miles above Hospital Rocks." At the same time, permission to make surveys within Sequoia National Park for the construction of conduits, roads and support structures was requested of the Secretary of the Interior (SCE Kaweah No. 1: 110). In spite of an act passed by Congress in 1901 that permitted the Secretary of the Interior to permit the granting of rights of way on public lands for hydroelectric power, the requests of the Mount Whitney Power Company were repeatedly denied. Permission was finally granted in 1906 and as a provision of obtaining the right of way, the company agreed to build a wagon road within the park that could be used by park officers and the public. In addition, the company agreed to pay "2 1/2 percent of the gross receipts from the sales of the electric current produced during

the previous calendar year through the operation of the waters to be diverted by it within the park" This money was to be given to the park directly to be used for operating expenses (Mount Whitney Power Company 1906).

This last provision became a serious cause of contention between the Interior Department and the power company during the ensuing years. The basis for computing the charge was changed in 1912 which resulted in much lower payments. In 1915, the Secretary of the Interior informed general manager, Ben Maddox, that the original method of computation would be resumed. Emphasizing the fact that, as a rule, he was opposed to using parks as power sites, the Secretary informed Maddox that whenever an exception to the rule was made, "the government should receive very ample compensation" (Lane 1915). Maddox replied with considerable outrage:

. . . just why a concrete flume would detract from the beauties of the foot hills of Tulare county, or why such a flume would in any way limit the use of said foot hills as a playground of all the people, I do not understand. None of the people are going to play in that part of the Sequoia National Park where these conduits are, and if perchance some tourist should stray up the side hill, he would undoubtedly conclude that a drink of water (other wise unobtainable) would more than compensate him for the few acres of greasewood that the water conduit supplants. (Maddox 1915).

Maddox then went on to say that the Agriculture Department charged considerably less for right of way through National Forests and it was ultimately the rate payers of Tulare County who paid the bills. His logic failed to move the Secretary, however, and the company continued periodically to apply for payment reductions to no avail.

Construction of Kaweah No. 3 (1907-1913)

When the final approval on the company's application for right of way in Sequoia National Park was issued by the Interior Department on February 25, 1907, a major obstacle to the construction of Kaweah No. 3 was eliminated. The permit, however, included only that

part of the system located within the park and an additional permit was necessary from the Secretary of Agriculture for parts of the plant located in what was then part of Sierra National Forest. A temporary permit was granted on June 30, 1909 followed by a 50 year permit issued on June 15, 1912. The latter was superseded by a Federal Power Commission license in 1924 (SCE, 1950: 110-111).

Although original plans called for the construction of a much more extensive system, Kaweah No. 3, completed in 1913, proved to be the final major addition in the project. The plant derived its water supply from two diversions, one in the Middle Fork, about three quarters of a mile above the junction of the Marble Fork and the other on the Marble Fork, about the same distance from that junction. Both diversion dams were low concrete structures similar in design. The intake on the south bank of the river at the Middle Fork diversion was formed by a heavy masonry wall extending to form the outer wall of the canal. Beyond the wall was a set of sluice gates to control the flow into the canal. The Marble Fork diversion operated in much the same way with its canal running along the north bank of the Marble Fork to above the junction of the two branches. It terminated in a sandbox and an overflow siphon. This terminus, a concrete lined box, acted as a head-box for a steel inverted siphon that carried the flow of the canal across the Middle Fork to a junction with the canal line from the Middle Fork diversion. The flow was joined at this point and carried in a continuation of the Middle Fork conduit. This followed the east slope of the Middle Fork and ended in a forebay reservoir for the No. 3 powerhouse.

When built, the system was considered to have several interesting engineering features, the most innovative being the construction of the concrete conduit line. Of the 25,000 feet of conduit 15,700 feet was made by a method called slab-bench construction. 12,700 feet of this was single slab conduit 4 feet deep and 8 feet wide on the bottom and it was constructed by excavating a bench along the hillside. Where the ground was too rugged

or steep to be reached by a steam shovel, the digging was done by hand. A reinforced concrete slab was placed in position to form a vertical wall on the downhill or outside of the bench. A concrete line 3 inches thick was then placed on the uphill side and continued halfway across the bottom. This line was increased in thickness and reinforced until it reached a junction with the slab. The double slab conduit, which comprised 3,000 feet of the system, was 4 feet deep by 9 feet 6 inches wide. Its construction was similar to that of the single slab except that vertical slabs were placed on both the uphill and downhill sides. In order to produce these slabs on site, a flat area between the two forks was used as a construction yard. A crushing plant was built to use the sand and gravel from the stream bed for making concrete. With these raw materials the "L" shaped slabs were fabricated in wooden forms built in the yard. To transport the slabs to the construction area, a double track was built for cars that carried both the slabs and the portable derrick for lifting them. For most of the line, the slabs were placed in ditches. In areas where the grade was too steep, however, concrete piers supported the conduit, which was constructed entirely of preformed slabs. The durability of this method of construction is evidenced by the fact that the conduit line is still in use (Van Norden 1913: 8-11; Fowler 1923: 657).

A regulating reservoir 315 feet long, 15 to 70 feet wide and 7 to 22 feet deep was completed in September 1913. Below the reservoir, 243 feet of pressure pipe was laid nearly horizontally along the hillside and terminated at a standpipe 27 feet high and 42 inches in diameter. The pipeline then turned and dropped down hill. At the powerhouse, the lower end of the pipe was connected with a cast steel "Y" and embedded in a block of concrete (Fowler 1923: 658; Van Norden 1913: 19).

The powerhouse for Kaweah No. 3 was more substantial in construction than the previous two and had the advantage of being completely fireproof. Built of reinforced concrete,

it was 50 feet by 50 feet on the inside. The generator room, 50 feet long by 34 feet wide, extended across the back of the building on the side where the pipeline entered.

The generators were Westinghouse 1,750 k.v.a., 2,300 volt, 3 phase 60 cycle machines directly connected to the impulse wheels. The two units were operated by Pelton-Doble 77 inch single overhung impulse wheels having a maximum rating of 3,000 horsepower and running at 300 revolutions per minute. Each impulse wheel was controlled by a Pelton automatic oil-pressure governor that operated a main needle valve. In addition, an auxiliary needle valve was provided with a Lombard relief valve installed in the pipeline just outside the powerhouse as a further safeguard.

Two 55 kilowatt exciters were installed in the station; one driven by a Pelton water wheel and the other by an 82 horsepower 2,300 volt, 3 phase induction motor. The four transformers were 1,250 k.v.a. single phase, oil insulated and water cooled. To provide for cooling, water was pumped from the tailrace into a tank on the hillside above the powerhouse. A switchboard, consisting of five panels finished in natural black slate was erected 7 feet from the wall separating the generator and the switch rooms. A tramway was also built as part of the system. It started a short distance below the powerhouse and followed the pipeline to the top.

The original 2 1/2 mile long pole line connecting Kaweah No. 3 powerhouse with the main line at Kaweah No. 1 was wooden. By 1923, it had been replaced with a steel wishbone cross arm power line which was designed for operation at 60,000 volts (Van Norden 1913: 18-21; Fowler 1923: 658-660).

Final Developments and Sale of Mount Whitney Power and Electric Company (1910-1920)

Between the years 1910 and 1916, demand for power increased greatly as the use of electricity for irrigation became widespread. The transmission lines of Mount Whitney

Power and Electric Company soon extended to the towns of Exeter, Tulare, Porterville, Delano and other small farming areas in between (Myers 1983: 96).

These demands made it necessary to pursue increased development. Original plans for the Kaweah system had called for the construction of a dam and reservoir at Wolverton Creek as well as an additional powerhouse. A serious setback to expansion occurred in 1913 when the St. John's River Association objected to Mount Whitney's plan to store the flow of Wolverton Creek. It served notice on the company and White Construction, the contractor, to cease and desist construction on the Wolverton Dam and reservoir. The Association based its objection of the earlier judgment in 1909 which ruled that Mount Whitney could not interfere with the natural flow of any of the tributaries of the Kaweah River when the flow was less than 2,400 c.f.s. Considerable work already had been completed at the Wolverton Dam site and a road had been constructed connecting the site with a Park Service road. As a result of the Association's objection, however, the project had to be abandoned (SCE 1950: 112).

In 1915, Mount Whitney bought out its rival, the Tulare County Power Company (Minutes of Mount Whitney Power and Electric Company June 29, 1915). To meet the demand for power, it's small steam plant was used with increasing frequency along with the steam station at Visalia which had been expanded in 1914. The increased reliance on steam stations proved to be very expensive and by 1916, Mount Whitney was facing financial difficulties.

While the company had been successful in forcing out rivals in Tulare County, it was not nearly so successful in dealing with A.G. Wishon's San Joaquin Power Company. Determined to best his former associates at Mount Whitney, Wishon aggressively pursued development within the San Joaquin Valley by first purchasing Bakersfield's electric utility system and later by building a hydroelectric plant on the Tule River. These moves

effectively prevented Mount Whitney from further expansion outside of the Tulare County area where it had been so successful (Myers 1983: 96).

In 1916, an aging John Hays Hammond decided to withdraw from the power business and once again sought a purchaser for his company. At the same time, Henry Huntington's Pacific Light and Power Company was looking for a San Joaquin Valley outlet for the hydroelectric energy produced by its Big Creek Project. In June 1916, Henry Huntington purchased John Hammond's controlling interest in Mount Whitney Power and Electric Company. Three months later the Board of Directors was requested to resign and a new directorate was elected (Mount Whitney Power and Electric Company 1909-1922: Minutes, September 5, 1916). Pacific Light and Power Company policy dictated that Mount Whitney should continue business under its own name and, although the Board of Directors was replaced, day to day operations continued under Ben Maddox, who had been general manager since 1902 and vice-president since 1908.

In 1917, Huntington sold his electric power interests to Southern California Edison which included control of Mount Whitney Power and Electric Company (Myers 1983: 99). In 1920, the company ceased to exist as a subsidiary and the corporation was officially dissolved on March 14, 1922 (Mount Whitney Power and Electric Company 1909-1922: Minutes, March 23, 1920, March 14, 1922). There was continuity on the local level, however, as Ben Maddox became Edison's San Joaquin Division Manager and served in this position until his death in 1933.

Kaweah Under the Southern California Edison Company

Administration

With the absorption of the Kaweah Project into the larger Southern California Edison system, adjustments to development plans were necessary. In 1921 Edison completed and placed in operation Kern River No. 3 plant and Big Creek No. 8, added a third unit to Big Creek Powerhouse No. 2 in 1922, and planned further additions to Powerhouse No. 1 in 1925. These additions had their affects on the newly acquired Kaweah system.

Mount Whitney had originally planned to build an additional powerhouse, Kaweah No. 5, above the intake of Kaweah No. 3 (Van Norden 1914: 12-13). The 1912 permit from the Department of the Interior, transferred to Edison in 1920, provided for the completion of Kaweah No. 5 by 1919 and the deadline was extended later to 1924. SCE applied for another extension in 1923 emphasizing the fact that the company's resources had been concentrated on developing Big Creek, among other facilities, and asked that completion of Kaweah No. 5 be once again delayed until 1930 (SCE 1923).

Taking up the argument that Ben Maddox had made in 1915 for a reduction in rates paid by the utility to Sequoia National Park, Edison once more argued that the charges were excessive. Negotiations between Park Superintendent, John R. White, his superiors at the Park Service and the company resulted in an agreement to reduce rates in 1927 (Edwards 1930). In exchange, Edison agreed to make installations and maintain equipment to provide the park with extended electrical services. Unfortunately for both sides, the U.S. Comptroller General ruled in 1928 that such an agreement was not permissible under the law and the old rate structure remained in effect (McCarl 1928).

In March 1930, Southern California Edison announced that "the development of this (Kaweah No.5) plant is not of sufficient economic value to justify construction, and the

permit may be canceled in so far as it applies to the construction of Kaweah No. 5 power plant" (Reppy 1930).

Negotiations continued over the years to establish what Edison considered an equitable payment structure. Later discussions centered on measurement of stream flows as part of this rating structure and stream gaging stations were established at the Middle Fork spill past the SCE diversion point; the Middle Fork conduit at the diversion point and the Marble Fork spill past the diversion point and Marble Fork Conduit diversion to the hydro plant (Briggs 1950).

When the Special Use Permit with Sequoia National Park expired in 1962, Southern California Edison petitioned Congress for a 50 year renewal. Because of the length of time since Congress had investigated the project, it authorized the Secretary of the Interior to grant a permit extension that would expire in 1974, thus providing time to review the project. The Special Use Permit issued on September 23, 1964 included a special condition that specified minimum flow levels to be maintained in the natural channel. Prior to this time, the capacity of the diversion flumes often exceeded the volume of natural river flow during the late summer months. When this happened no water was released to the natural waterway.

Another Special Use Permit, also for 10 years, was issued on December 13, 1975. It too contained a minimum flow release schedule and other conditions relating to fish barriers, vegetation clearing and wildlife protection (Jordan/Avent and Assoc. 1983: 10-12).

Besides the ongoing permit process, Edison had another important interaction with Sequoia National Park. In 1936, Park Superintendent John R. White suggested that a triangular piece of land belonging to Edison and located near the park entrance be exchanged for the land within the park occupied by the company's facilities. To authorize

this trade an act of Congress was passed on December 21, 1943. Edison's land was conveyed to the United States on January 29, 1946 and on October 20, 1950 the federal government deeded the agreed upon tract to Southern California Edison (SCE 1952: 112-113).

Maintenance of Kaweah System Under Edison

With the abandonment of the Wolverton Dam and Reservoir in 1915 and the decision not to build another powerhouse in 1930, few changes were made to the system after 1913, the year that Kaweah No. 3 went into operation. Maintenance and replacement of various parts including Powerhouse No. 1 have been carried out but the system operates in much the same manner as its planners designed it.

Over the years, the installation of automatic equipment has made constant tending by and on site crew unnecessary. Powerhouse No. 1 was torn down and replaced in 1929 by one located 100 feet to the north and adjacent to the Kaweah River. Another project, in 1947, involved replacing the wooden flume portions of the conduit with metal flumes (SCE Kaweah No. 1: n.d.a.).

At Powerhouse No. 2, two of the three main generating units were replaced prior to 1913 by a single, larger unit and in 1929 the third unit was replaced by a larger one (Van Norden 1913: 17). In 1947 this unit was removed. Powerhouse No. 3 still contains the original Pelton-Doble single impulse water wheels and 1,750 kva Westinghouse generators although the No. 1 and No. 2 water wheels have had needles, nozzles and buckets replaced (SCE Kaweah No. 1: n.d.b.).

The intake flume and forebay of the conduit system of Kaweah No. 1 has been repaired and reconstructed over time (SCE Kaweah No. 1: n.d.c.). The Kaweah No. 2 conduit has undergone only routine maintenance except for the replacement of the wooden flume

portions and intake gates (SCE Kaweah No. 1: n.d.d.). The concrete slab conduit of Kaweah No. 3 has remained virtually unaltered since its construction and stands today as a tribute to the farsighted designers who built it (SCE Kaweah No. 1: n.d.e.).

Conclusion

The transformation of a sparsely populated, dry farming region to an area of prosperous plots planted with fruit trees and olive groves was looked on as nothing short of miraculous by Tulare County residents. The credit, with ample justification, went to the electrical energy made available through the Mount Whitney Power and Electric Company. In a report issued by the Forest Service in 1911, W.L. Huber, Forest Service Engineer said, "I believe that more agricultural development has been accomplished per unit of power from this company's system than from any other in California" (quoted in Maddox 1914: 29).

In 1903 the average load generated by the company was 860 horsepower and the number of customers 710. By the end of 1919, the average was 51,363 horsepower and the number of customers had risen to 12,781 (Fowler 1923: 584). Over 67,000 acres of olive, citrus and other crops were under irrigation using power from the Mount Whitney system. It is not surprising that over 86 percent of the power generated by the company was used for agriculture (Fowler 1923: 582).

This change in land use had the expected effect on property values. From 1893 to 1900 there was a loss in assessed valuation of Tulare County property of over \$642,000, while from 1900 to 1910 the county assessor reported a gain of \$22 million. From 1900 to 1914 the increase in assessed values was \$33 million or 218 percent. In the proud words of Ben Maddox, "Of this gain would it be too much to say that at least \$20 million is the direct result of the motors now in use on the Mt. Whitney Power and Electric Company's system for pumping water?" (Maddox 1914: 28).

The Kaweah system, built by Mount Whitney, was undoubtedly the single most important factor in the establishment of the type of agriculture practiced in Tulare County today. Although relatively small and similar in design to other systems developed at the same, Kaweah with its high head and concrete slab conduit system gives it a significant place among the pioneer efforts at long distance transmission.

Now a part of the larger energy delivery system of Southern California Edison Company, the powerhouses and water delivery systems of Kaweah still function effectively and stand as reminders of the vision, determination and skill of their developers.

CHAPTER 3

RESOURCE INVENTORY AND STATEMENT OF SIGNIFICANCE

The Kaweah Hydroelectric System contains numerous historical resources that reflect both the development and long period of power generation on the Kaweah River drainage. This chapter provides an inventory of these resources, an evaluation of their significance (with reference to the National Register of Historic Places), and recommendations for future management of significant historical resources associated with the system.

The DPR 523 forms, found in appendices A-D, provide complete descriptions of the buildings and structures 50 years or older. The table Index to Buildings and Structures also lists the full inventory of buildings and structures. The inventory provided below is broken into four sections based on the three powerhouses and the cluster of four remote reservoirs. (Note: Building numbers cited in the text, table and DPR 523 forms are taken from SCE property records.)

Kaweah No. 1 Powerhouse and Associated Buildings and Structures (See Map 2)

Powerhouse No. 1 (Building No. 0101)

Powerhouse No. 1 was constructed in 1928-1929 adjacent to the Kaweah River and downslope from the original Powerhouse No. 1. It is a simple, reinforced concrete building in the neoclassical industrial style, and houses a single generating unit. The unit is fed by a flume and penstock which diverts water from the East Fork of the Kaweah River. Alterations to the building have been minor and are described in Appendix A.

INDEX TO BUILDINGS AND STRUCTURES
KAWEAH HYDROELECTRIC SYSTEM

Location	Building No.	Name	Date of Construction	Form DPR 523
Powerhouse No.1	0101	Kaweah No.1 Powerhouse	1928-1929	yes
Powerhouse No.1		Kaweah No.1 Substation	1928-1929	yes
Powerhouse No.1	0102	Supervisor's Office	ca. 1950's	
Powerhouse No.1	0107	Machine Shop	1927	yes
Powerhouse No.1	0110	Carpenter Shop, Gas House and Garage	1927	yes
Powerhouse No.1	0121	Cottage	ca. 1927	yes
Powerhouse No.1	0123	Garage	ca. 1927	yes
Powerhouse No.1	0126	Communication House	ca. 1950's	
Powerhouse No.1	0128	Storage Shed	ca. 1920	yes
Powerhouse No.1		Penstock	1899	yes
Powerhouse No.1		Forebay	1947	
E. Fork Kaweah R.		Flume	1947	
E. Fork Kaweah R.		Intake	1947	
E. Fork Kaweah R.		Eagle Lake	1904	yes
E. Fork Kaweah R.		Franklin Lake	1905	yes
E. Fork Kaweah R.		Monarch Lake	1905	yes
E. Fork Kaweah R.		Crystal Lake (Silver Lake)	1903	yes
Powerhouse No.2	0101	Kaweah No.2 Powerhouse	1905	yes
Powerhouse No.2		Kaweah No.2 Substation	1925	yes
Powerhouse No.2	0114	Water Tank	ca. 1948	
Powerhouse No.2	0107	Restroom	ca. 1947	
Powerhouse No.2		Penstock	ca. 1905	
Powerhouse No.2		Forebay	ca. 1905	
Powerhouse No.2		Flume	1947	
Kaweah River		Intake	ca. 1905	
Powerhouse No.3	0101	Kaweah No.3 Powerhouse	1913	yes
Powerhouse No.3	0121	Garage	1948	
Powerhouse No.3	0125	Instrument Building	ca. 1950	
Powerhouse No.3		Penstock	ca. 1913	
Powerhouse No.3		Forebay	ca. 1913	
Marble Fork, Kaweah R.		Conduit and Siphon	1912-1913	yes
Marble Fork, Kaweah R.		Marble Fork Diversion Dam	ca. 1913	
Middle Fork, Kaweah R.		Middle Fork Conduit	1912-1913	yes
Middle Fork, Kaweah R.		Middle Fork Diversion Dam	ca. 1913	

MAP 2. Kaweah Powerhouse No. 1 Vicinity

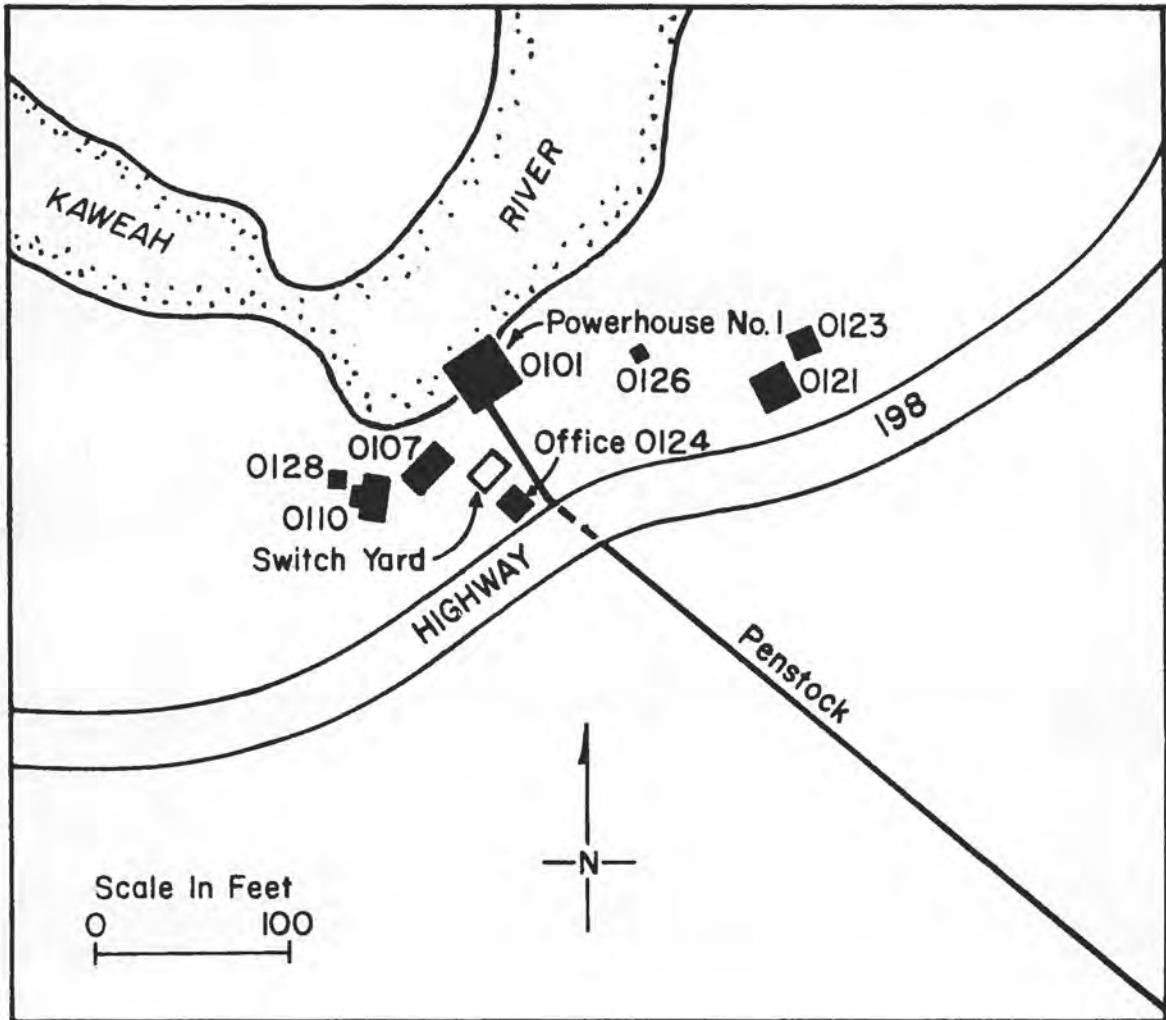

Kaweah No. 1 Substation

This outdoor substation was constructed in 1928-1929 in conjunction with the relocated Powerhouse No. 1. Although some maintenance and replacement in-kind of equipment has occurred, the four original transformers are still in place.

Kaweah No. 1 Machine Shop (Building No. 0107)

This is a simple wood frame building with corrugated metal siding and a metal roof. Built in 1927, construction coincided with the relocation and reconstruction of Powerhouse No. 1. A partial cement floor laid in 1951 is the only alteration to the building.

Kaweah No. 1 Carpenter Shop (Building No. 0110)

This wood framed building was constructed in 1927 and is in the simple industrial utilitarian style. Originally used as a garage, a carpenter shop, and gas pumps have been added at unknown dates. In 1973 the carpenter shop was enlarged.

Kaweah No. 1 Cottage (Building No. 0121)

This is the last remaining residential cottage in the Powerhouse No. 1 complex. The building was probably constructed in the mid-1920s and is a simple neoclassic style bungalow. This residence is essentially unaltered, except for the addition of asbestos shingles in 1959.

Kaweah No. 1 Garage (Building No. 0123)

This garage, constructed in the neoclassic style in the mid-1920, is the only remaining garage structure in the Powerhouse No. 1 complex. Asbestos shingles added in 1959 appear to be the only alterations to the original structure.

Kaweah No. 1 Storage Shed (Building No. 0128)

This is a small, wood frame shed built in 1920 with shiplap siding and a metal roof. Its original function was as a flume tender's tool shed and is now used to store chemicals. The building has no known alterations.

Kaweah No. 1 Penstock

This penstock was constructed in 1899 by the Mount Whitney Power Company for service to the original Powerhouse No. 1. The Penstock was extended in 1928-1929 to accommodate the downslope location of the new Powerhouse No. 1, and in 1967 the upper 300 feet of the penstock was replaced. In 1984, the upper 50 feet of the tapered section was replaced, and in 1987 the lower 700 feet of the 1929 extension was replaced. This penstock is one of the few remaining elements of the original Kaweah No. 1 facility designed and constructed by Mount Whitney Power.

Kaweah No. 1 (Other Associated Buildings and Structures)

Several other buildings and structures that are less than 50 years old are located in the vicinity of Kaweah No. 1. These are: the Supervisors Office (Building No. 0102); the Communication House (Building No. 0126); and the flume, forebay and intake.

Kaweah No. 2 Powerhouse and Associated Buildings and Structures (See Map 3)

Kaweah No. 2 Powerhouse (Building No. 0101)

This powerhouse is a wood frame industrial style building that was constructed in 1905 and originally housed three generating units. Two of these were removed sometime prior to 1913 and replaced with a larger, single unit. This larger unit was removed in 1947 and placed in service in SCE's Santa Ana River Plant No. 3. The remaining original unit was replaced with a larger one in 1929. Minor modifications and maintenance are the only alterations to the building. The powerhouse is supported by an intake, penstock, and forebay, all of which were constructed in 1905. These structures have undergone regular maintenance and some modification through time. A motor operated leaf rake was installed in 1951, and the penstock was apparently modified at the lower end when the turbine units were changed. The flume, originally constructed in 1905, was essentially rebuilt in 1947 when wooden portions of the flume parts were replaced with steel parts and new intake grates were installed.

MAP 3. Kaweah Powerhouse No. 2 Vicinity

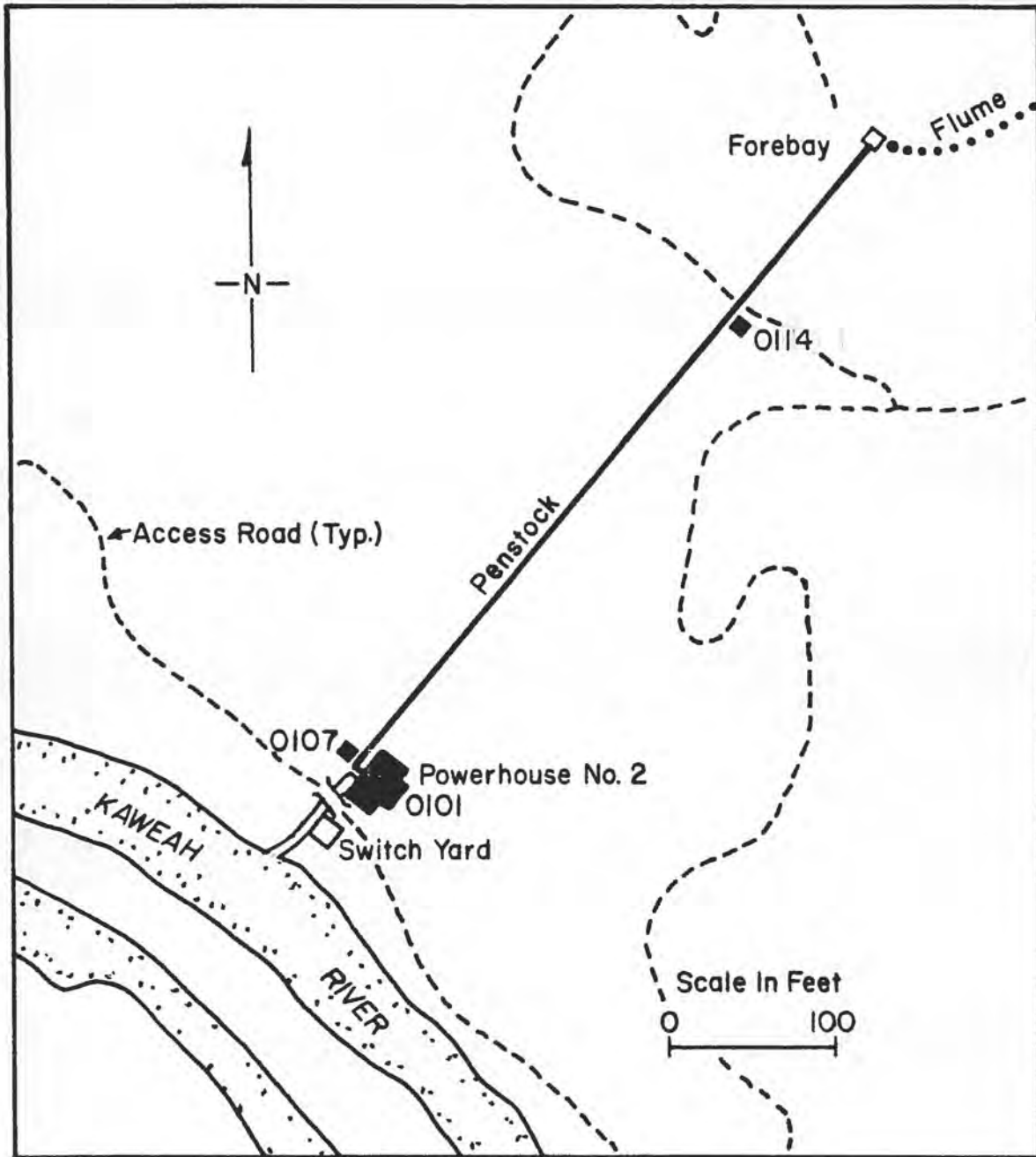

Kaweah No. 2 Substation

This outdoor substation was constructed in 1925. The transformers were moved to their present location in 1947. Major maintenance in 1947 is the only change to the transformers since their installation in 1925. The cyclone fence which now surrounds the substation was erected in 1975.

Kaweah No. 2 (Associated Structure)

Two additional structures, a water tank constructed in 1947 (Building No. 0114), and a restroom (Building No. 0107, constructed in 1947) are associated with the Kaweah Powerhouse No. 2 complex.

Kaweah No. 3 Powerhouse and Associated Buildings and Structures (See Map 4)

Kaweah No. 3 Powerhouse (Building No. 0101)

The Kaweah No. 3 Powerhouse is a reinforced concrete structure built in the industrial style in 1913. The powerhouse's two generating units are both virtually unaltered since installation in 1913, except for routine maintenance and replacement in-kind of water wheels and nozzles. The removal of two windows is the only substantial alteration to the building. The powerhouse is supported by a penstock and forebay, both constructed in 1913.

Kaweah No. 3 Marble and Middle Fork Conduits

The water conduit systems, which divert water from the Marble and Middle forks of the Kaweah River, are constructed of slab concrete and lined with concrete. The Marble Fork Conduit is approximately 5,000 feet in length and terminates in a head-box for a 1,085 foot riveted steel pipe siphon that transfers water to the 20,000 foot Middle Fork Conduit. The conduit system was constructed in 1913 as part of the water delivery system for Powerhouse No. 3. The conduits begin at diversion dams on the Middle and Marble forks. Both dams were constructed in 1913. The conduits were only altered in 1947 when a layer of gunite was applied. Because of its unique design and integrity, the entire

MAP 4. Kaweah Powerhouse No. 3 Vicinity

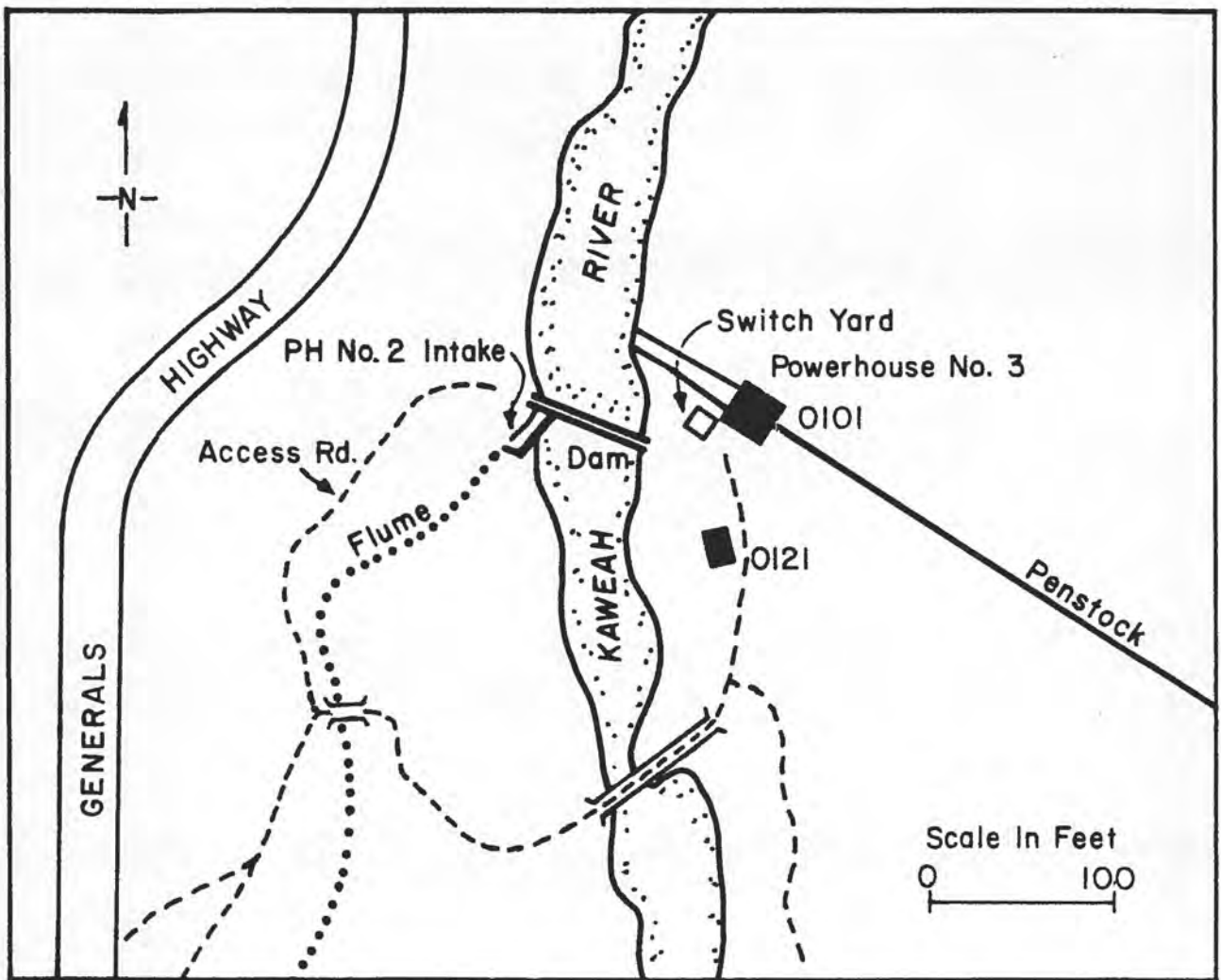

concrete slab conduit and syphon system is recommended for inclusion on the National Register of Historic Places (see Statement of Significance [below] and Appendix D for detailed discussion of the historic significance of the Kaweah No. 3 conduit system).

Kaweah No. 3 (Associated Building)

The Kaweah No. 3 instrument building (Building No. 0125) was constructed in 1950.

Eagle, Monarch, Crystal, and Franklin Lakes

These four reservoirs were constructed between 1903 and 1905 and provide a controlled flow into the East Fork of the Kaweah River for the delivery of water to Powerhouse No. 1. These simple dams are built of stone and capped with concrete, or stone set in concrete. Due to the rigors of high elevation, loose or crumbling mortar is routinely removed from the dams. Each of the dams is inspected annually and repairs are completed on an "as needed" basis.

Statement of Significance

Southern California Edison's Kaweah Hydroelectric System has elements that are of architectural, historical and technological significance under the primary theme of economic/industrial history. Not all elements stand on their own as eligible for the National Register of Historic Places primarily because of a lack of physical integrity. Those structures and buildings that do possess historical integrity and reflect the role of the Kaweah System in the history of rural electrification in California are found in the proposed district that includes Kaweah No. 3. The themes that integrate the buildings and structures of this proposed district are rural electrification and the application of electric power to agricultural pumping for the purpose of irrigation.

California was one of the first states to develop rural electrification. By the mid-1920s, farmers had tried hydroelectric power, early power companies saw and exploited rural profit potentials, and farming interests assisted in developing the rural market. Elsewhere

in the nation, however, electricity remained an urban phenomenon well into the 1940s. Cities offered concentrated domestic, industrial, and commercial markets; farming regions promised only high service costs and little or no profit. Most of the nation's power companies did not consider rural service feasible, and farmers remained untended until after Franklin D. Roosevelt created the Rural Electrification Administration in 1935 (Williams, 1989: *passim*).

Ironically, it was the electrification of cities that helped accelerate rural electrification in California. Scarce traditional energy sources had stunted the state's urban manufacturing development. The state had little coal, wind power was fickle, and production from newly discovered oil fields fluctuated sharply even into the early 1900s. As early as the 1890s, engineers and entrepreneurs had begun to uncork the Sierra Nevada's hydroelectric potential for providing electricity to cities. By 1900, many entrepreneurs had formed power companies and installed transmission lines to deliver this hydroelectric energy from the Sierra Nevada to San Francisco, Los Angeles and other distant urban areas.

These long-distance transmission lines soon crisscrossed the great Central Valley and smaller agricultural valleys in California, providing these rural areas access to electricity. Some power companies recognized a potential new market and focused on providing electricity to California agriculture.

Irrigation became the principal market which Albert Wishon sought to tap when he formed the Mount Whitney Power and Electric Company in the late-1890s. He recognized that wind power was insufficient for many crops, that gasoline engines were temperamental, and that electric pumping could not only help existing farms but open up new lands to farming. Wishon became California's electrical pumping irrigation pioneer, and by 1915 Mount Whitney's three plants produced electrical power for pumping water on 67,481 acres as well as providing electric power to one-third of Tulare County's farm homes. Agriculture amounted to almost 90 percent of the company's load. Wishon

himself had left the firm to join the San Joaquin Light and Power Corporation after 1903, where he also encouraged the state's first commercial cotton farming, introduced electric power for oil pumping, and reduced rural power costs by developing unattended, outdoor high-voltage transformer stations (Williams, 1985: 183-185; Williams, 1989: passim).

Other companies followed the lead of the Mount Whitney Power and Electric Company. Southern California Edison, Pacific Gas and Electric and Great Western Power developed substantial irrigation pumping loads by the 1920s. One firm helped land developers create new 40 to 140 acre electrified farms. Others reclaimed marsh and delta lands for new crops and undertook controlled flooding of arid plains to begin the state's rice industry. A 1927 electrical energy use survey indicated that irrigation comprised 12.27 percent of the state's total electrical consumption. Of eleven western states, California accounted for 80.2 percent of the electricity used in irrigation pumping and led all other states in general rural electrification (Williams, 1989: passim).

National Register of Historic Places Eligibility

Those elements of the existing Kaweah system which should be considered significant based on the pioneering role of the Mount Whitney Power and Electric in rural electrification and electric pump irrigation are the historical buildings and structures of the Kaweah No. 3 powerhouse complex. These include the powerhouse and Marble Fork and Middle Fork diversion and conduit and syphon. These elements of the powerhouse No. 3 complex should be nominated as a district for listing on the National Register of Historic Places under NRHP criteria A and C. Powerhouse complexes No. 1 and No. 2 have undergone significant alterations and modifications and therefore lack historical integrity and are not considered eligible for inclusion in the NRHP. A discussion of the each powerhouse complex relative to NRHP eligibility criteria follows.

Kaweah No. 1

Kaweah Powerhouse No. 1 is architecturally interesting, but not distinctive among other small powerhouses of its time of construction (1928-1929). While the powerhouse is the focal point of the Kaweah system, it is not representative of the original design and construction (either architecturally or technologically) of the System, since it replaced the original Powerhouse No. 1. Other historic buildings in the Powerhouse No. 1 complex include the machine Shop (Building No. 0107), storage shed (No. 0128), carpenters shop (No. 0110), and cottage and garage (Nos. 0121 and 0123). None of these is architecturally interesting and date from the time of construction of the new Powerhouse No. 1. As such, these elements of the System do not appear to satisfy either criterion A or C for eligibility to the NRHP. They do not represent "events that have made a significant contribution to the broad patterns of our History" (criterion A). Also, they do not possess, either singly or in the aggregate, "the distinctive characteristics of a type, period or method of construction", nor do they "represent the work of a master" (criterion C).

Kaweah No. 2

Built in 1905, Powerhouse No. 2 is also historically and architecturally interesting. The industrial architectural style of this structure is practical, and reflects the limited financial backing which the Mount Whitney Company possessed in its early years. The construction materials are an interesting mix, with wood framing commonly used in industrial structures before 1900 and corrugated iron sheathing and roofing commonly used after 1900. It represents a transitional period in use of construction materials for industrial structures (Rifkind, 1980: 271-312). It also is constructed in the same style and very close to the same plan as the original Mount Whitney Power and Electric Company Kaweah Powerhouse No. 1, which was torn down in 1929.

While Powerhouse No. 2 is historically interesting it does not appear to embody the characteristics which would make it eligible under NRHP criteria A or C. Of particular importance are the many significant modifications made to the generation equipment since

the original date of construction (1913, 1929 and 1947). The remaining associated historic structures (the penstock and forebay), while little modified, are not distinctive individually.

Kaweah No. 3

Kaweah Powerhouse No. 3, constructed in 1913, is historically and architecturally interesting. The industrial architectural style of this structure is attractive and a good representation of early 20th century reinforced concrete construction. It represents increased prosperity for the Mount Whitney Power and Electric Company, when compared to the building materials and styles used in Kaweah plants No. 1 and No. 2. As with Powerhouse No. 2, the integrity of the structure is excellent and in fine condition, having undergone virtually no alterations. It also contains most of the original powerhouse equipment.

Other elements of the system which possess historical significance include Kaweah No. 3's Marble Fork and Middle Fork conduits, siphon and diversion dams. These are unique engineering features, embodying a distinctive method of construction. Especially distinctive are 1) the on-site fabricated concrete slabs; and 2) the design and construction of the siphon system which connects the conduits and drainages. In addition, in the researcher's experience, the Kaweah flowline and siphon design are probably unique among the early hydroelectric projects in California. The conduits are virtually unaltered, although washed out and leaking sections were regularly repaired. The integrity of the conduits and siphon are good.

In 1968, the dam and intake structures of both conduits and the retaining walls along the conduit to Kaweah No. 3 were repaired. However, the conduit repairs in no way damage or detract from the original construction. The conduits and siphon, because they represent a distinctive method and type of construction, and possess good integrity relative to their original appearance.

PROPOSED KAWEAH NO. 3 NATIONAL REGISTER OF HISTORIC PLACES DISTRICT

The Kaweah No. 3 complex of the Kaweah Hydroelectric System is potentially eligible for nomination to the National Register of Historic Places under criteria A, broad patterns of our history, and C, distinctive character of construction. Under Criterion A, the general theme of generation and transmission of electric energy integrates all the features of this district. By association, the complex is also linked to the early use of this energy for the purpose of irrigation pumping. This innovative concept was developed by the Mount Whitney Power and Electric Company, and was the primary purpose for which the Kaweah system was built.

Under Criterion C, several elements of the system possess historical significance. These include the on-site fabricated concrete slabs used for the conduit and the design and construction of the siphon system, which are apparently unique to the Kaweah system.

The Kaweah No. 3 complex qualifies as a district because it possesses a significant concentration of buildings and structures united historically by plan. Built during the years 1912-1913, the complex represents the last stage of development of the Kaweah Hydroelectric System. The water delivery system physically links together the elements of the complex, which operate unchanged since their design and construction. The conduits and powerhouse remain unaltered since construction. Therefore, the complex retains an integrity that is lacking in the Kaweah No. 1 and No. 2 complexes.

PERIOD OF SIGNIFICANCE

The period of significance of the Kaweah No. 3 Historic District is 1912-1913, the period when this part of the Kaweah system was built and the reinforced cement slab water delivery system, unique to Kaweah No. 3, was developed. This period was chosen because

all buildings and structures which contribute to the proposed NRHP District were constructed and put into operation during this period

CONTRIBUTING AND NON-CONTRIBUTING BUILDINGS AND STRUCTURES

A structure or feature is considered contributing to the historic district if it was built in the period of significance and possesses historical integrity. A structure or feature is considered non-contributing if it does not fall within the period of significance and does not represent the historic themes. The contributing and non-contributing elements of the proposed Kaweah No. 3 NRHP District are listed below.

Location	Building No.	Name	Date of Construction	Status
Powerhouse No. 3	0101	Kaweah No. 3 Powerhouse	1913	Con.
Powerhouse No. 3	0121	Garage	1948	Non
Powerhouse No. 3	0125	Instrument Building	ca.1950	Non
Marble Fork		Conduit, Siphon, Diversion Dam	1912-14	Con.
Middle Fork		Conduit, Siphon, Diversion Dam Penstock, Forebay	1912-13	Con.

DISTRICT BOUNDARIES

The boundaries of the proposed Kaweah No. 3 NRHP District conform roughly to the project boundaries established by SCE. Portions of the project are located within Sequoia National Park and on other public lands and exact project boundary descriptions have not been located for their system features. Legal property descriptions are available for the

tract in which Powerhouse No. 3 is located. The attached project maps provide some identification of the project boundaries.

The upper portions of the project, including the diversions, siphon, and the majority of the conduits, are located within Sequoia National Park. The Marble Fork Diversion is located in the NW 1/4 SE 1/4 of Section 23, T.16S., R.29E., M.D.M. and the Middle Fork Diversion is located in SW 1/4, NW 1/4 of Section 25, T.16S., R.29E., M.D.M. The conduits then run through portions of sections 23, 25, 26, 34, and 35, T.17S, R.29E., M.D.M. The conduits leave the park at the boundary of townships 16S. and 17S. The conduits then runs through public lands to the forebay and penstock. The lower portion of the penstock and Powerhouse No. 3 are located on Edison fee owned land in the North 1/2 of Tract 37, a portion of Sec. 37, T.17S., R.29E., M.D.M.

The proposed NRHP district boundaries may thus be discussed as follows:

1. Diversions and conduits. An area of 200 feet in width that includes the diversions and conduits in Sections 23, 25, 26, 34, and 35, T.16S., R.29E., M.D.M. (This boundary conforms to the Edison Project Boundary as described on SCE FERC Exhibit K Maps 521299, 521300, 521301 [Reproduced in Appendix E].
2. Siphon. An area of land 50 feet on either side of the Marble Fork Siphon in Section 26, T.16S., R.29E., M.D.M. This boundary conforms to the SCE project boundary described in the FERC Exhibit K Map 521301.
3. Forebay and Penstock. A corridor 400 feet wide that includes the Kaweah No. 3 forebay and penstock in Sections 3, 4, and 37, T.17S., R.29E., M.D.M., terminating at the point the corridor enters Edison's fee owned Tract 37, T.17S., R.29E., M.D.M. (as indicated on FERC Exhibit K Map 521299).
4. Powerhouse No.3. An area of land known as the north half of tract No. 37, T.17S., R.29E., M.D.M. (as indicated on FERC Exhibit K Map 521299).

REFERENCES CITED

Bridges, Revoe C.

1950 Letter, Revoe C. Bridges, U.S. Geological Survey to G.R. Woodman, Superintendent, Hydro Generation, Southern California Edison Company, January 5, 1950. On file Sequoia National Park, Lands and Recreation Planning Drawer, File L3031, Kaweah No. 3.

Doble, Robert McF.

1900 "The Mount Whitney Power Transmission," *The Journal of Electricity Power and Gas*, January, pp. 3-16.

Edwards, John R.

1930 Letter, John F. Edwards, Assistant Secretary, Dept. of the Interior to Roy V. Reppy, Vice-President, Southern California Edison Company. On file Sequoia National Park, Lands and Recreation Planning Drawer, File l3031, Kaweah No. 3.

Fowler, Frederick Hall

1923 U.S. Geological Survey. *Hydroelectric Power Systems of California and Their Extensions into Oregon and Nevada*. Water Supply Paper 493, Washington, D.C.: Government Printing Office.

Hays, John Coffee

1910 "Hydroelectric Power as Applied to Irrigation," *Transactions of American Institute of Electrical Engineers*, V. 29 pt. I San Francisco: May 6.

Jordan/Avent and Associates

1983 A Study to Evaluate the Impacts of Kaweah No. 3 Hydroelectric Facility on the Resources of Sequoia National Park.

Lane, Franklin K.

1915 Letter, Franklin K. Lane, Secretary of the Interior to Ben Maddox, October 21, 1915. On file Sequoia National Park, Lands and Recreation Planning Drawer, File l3031, Kaweah No. 3.

Los Tulares

1980 "Mount Whitney Power Company," *Quarterly Bulletin of the Tulare County Historical Society*, March, 1980.

Maddox, Ben M.

1914 Mt. Whitney Power and Electric Company, How It Was Financed, What it was Hoped would be Accomplished and the Results, SCE Document No. 78813.

1915 Letter, Ben Maddox to Franklin K. Lane, Secretary of the Interior, November 3, 1915. On file Sequoia National Park, Lands and Recreation Planning Drawer, File L3031, Kaweah No. 3.

McCarl, J.R.

1928 Letter, J.R. McCarl, Comptroller General of the U.S. to the Secretary of the Interior, April 4, 1928. On file Sequoia National Park, Lands and Recreation Planning Drawer, File L3031, Kaweah No. 3.

Menefee, Eugene L. and Dodge, Fred A.

1913 *History of Tulare and Kings Counties California*. Los Angeles, California: Historic Record Company.

Mount Whitney Power Company

1900-

1904 Minutes, Mount Whitney Power Company, January 1900 to May, 1904. Southern California Edison Archives Doc. No. 2948.

1904-

1907 Minutes of Stockholders and Board of Director's Meetings May 12, 1904 to November 10, 1907, Southern California Edison Archives Doc. No. 29419.

1906 Application of Mount Whitney Power Company for Right-of-way Within Sequoia National Park, February 26, 1906. On file Sequoia National Park, Lands and Recreation Planning Drawer, File L3031, Kaweah No. 3.

1908-

1912 Minutes of Stockholders and Board of Director's Meetings Jan. 1, 1908 to Dec. 16, 1912, Southern California Edison Archives Doc. No. 29420.

1911-

1914 Minutes of Stockholders and Board of Director's Meetings Nov. 10, 1911 to Dec. 31, 1914, Southern California Edison Archives Doc. No. 27360.

Mount Whitney Power and Electric Company

1909 Minutes of Stockholders and Board of Director's Meetings, Nov. 8, 1909 to Nov. 9, 1909, Southern California Edison Archives Doc. No. 35351.

1909-

1916 Minutes of Stockholders and Board of Director's Meetings, Nov. 9, 1909 to Nov.

5, 1916, Southern California Edison Archives Doc. No. 29422.

1914-

1922 Minutes of Stockholders and Board of Director's Meetings, Nov. 2, 1914 to March 14, 1922, Southern California Edison Archives Doc. No. 27360.

1916-

1919 Minutes of Stockholders and Board of Director's Meetings, September 5, 1916 to February 11, 1919, Southern California Edison Archives Doc. No. 21158.

Myers, William A.

1983 *Iron Men and Copper Wires*, Glendale California: Trans-Anglo Books.

Reppy, Roy V.

1930 Letter, Roy V. Reppy, Vice-President and General Council, Southern California Edison company to John R. White, Superintendent, Sequoia National Park, March 17, 1930. On file Sequoia National Park, Lands and Recreation Planning Drawer, File 13031, Kaweah No. 3.

Rifkind, Carole

1980 A Field Guide to American Architecture. New York: New American Library.

Small, Kathleen Edwards

1926 History of Tulare County California, Chicago: S.J. Clarke Publishing Co., Chicago.

Southern California Edison Company (SCE)

1923 Letter, SCE Senior Vice President to the Secretary of the Interior, December 10, 1923. On file Sequoia National Park, Lands and Recreation Planning Drawer, File 13031, Kaweah No. 3.

1924 Property Data Book. On file, Southern California Edison Company, Rosemead, CA.

1950 Kaweah No. 1 Hydro Electric Project. Project and Drainage Area Maps with Supporting Abstracts of Documents. [Compiled by W.E. Bergh]. On file, Southern California Edison Company, Rosemead, CA.

1951 Kaweah No. 2 Hydro Electric Project. List and Abstracts of Documents Relating to the Acquisition of Water Rights, Lands and Rights of Way with Project and Drainage Area Maps. [Compiled by W.E. Bergh]. On file, Southern California Edison Company, Rosemead, CA.

1952 Kaweah No. 3 Hydro Electric Project. List and Abstracts of Documents Relating to the Acquisition of Water Rights, Lands and Rights of Way with Project and Drainage Area Maps. [Compiled by W.E. Bergh]. On file, Southern California Edison Company, Rosemead, CA.

Southern California Edison Administrative Office, Kaweah Powerhouse No 1 (SCE Kaweah No. 1)

1906 Kaweah No. 1. File 059, Historical Files William Hays Hammond to John Hays Hammond, February 7, 1906.

n.d.a.SCE General Information File, Index to Work Orders.

n.d.b.SCE Data Sheet from Station Managers Record Book.

n.d.c.SCE Data Sheet, Kaweah No. 1 Flume and Penstock. Misc. Files, Requisitions and Reports.

n.d.d.SCE Data Sheet, Kaweah No. 2 Flume and Penstock. Misc. Files. Requisitions and Reports.

n.d.e.SCE Data Sheet, Kaweah No. 3 Water Conduit. Misc. Files. Requisitions and Reports.

Van Norden, Rudolph W.

1913 "System of the Mount Whitney Power and Electric Company," *Journal of Electricity Power and Gas*, December 27, pp. 5-36.

Williams, James

1984 "Energy Resources and Uses in Rural California: An Historical Overview," Dissertation, University of California Santa Barbara.

1989 "Otherwise a Mere Clod: California Rural Electrification." IEEE Technology and Society Magazine (December 1989).

Worster, Donald

1985 *Rivers of Empire*. Pantheon, N.Y.

APPENDIX A

**Historic Resources
Kaweah No. 1**

MAP 2. Kaweah Powerhouse No. 1 Vicinity

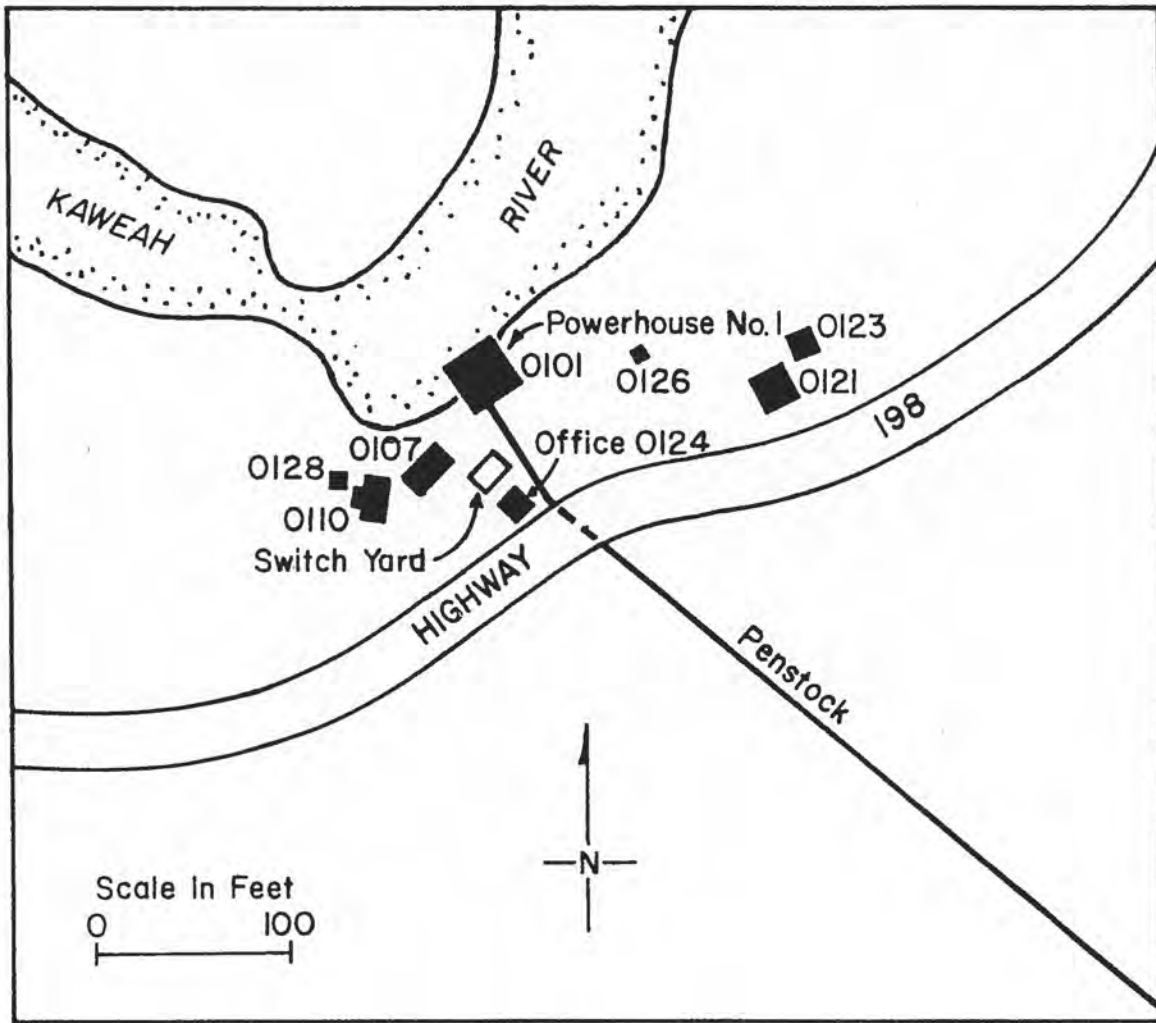

HISTORIC RESOURCES INVENTORY

IDENTIFICATION

1. **Common name:** Kaweah No. 1, Powerhouse - Structure 0101
2. **Historic name:** Kaweah No. 1 Powerhouse
3. **Street or rural address:** State Highway 198 at Hammond
4. **Parcel number:** NA
5. **Present owner:** Southern California Edison Company
2204 Walnut Grove Avenue
Rosemead, CA 91770

Ownership is private: XXXX

6. **Present use:** Hydroelectric Powerhouse
Original use: Same

DESCRIPTION

- 7a. **Architectural style:** Neoclassic Industrial
- 7b. **Present physical appearance:**

This simple reinforced cement industrial building has a flat asphalt roof with a 3 foot parapet surrounding it. An unadorned frieze surrounds the outer walls at the base of the parapet. Three identical 3 over 3 pane windows with narrow 2 pane sidelights are at the second floor level on the front facade (east). Beneath them is a double metal door, approximately 5' wide x 10' high, which serves as the main entry to the Powerhouse. A wrought iron fixture lamp with a round glass cover is mounted to the right of the doorway. To the left of the doorway, a small, open wooden overhang shed juts out from the wall. Fenestration similar to that on the front side is on the north, west, and south walls. On the north end of the west wall, a standard doorway opens into a small yard area enclosed by a cement wall.

8. **Construction date:** 1928-1929
Factual: XXXX
9. **Architect:** unknown

HISTORIC RESOURCES INVENTORY

Kaweah No. 1, Powerhouse - Structure 0101, page 2 of 4

10. **Builder:** Southern California Edison Company

11. **Approximate property size:** 22' x 26'

12. **Dates of enclosed photographs:** June 28, 1989

13. **Condition:**

Excellent: XXXX

14. **Alterations:**

The doorway in on the west end (back) of the structure was cut in in 1930. A shed was built off the south end of the east facade (front) in 1989. The decorative lamp matching the one to the right of the main doorway was replaced at this time with a small utility lamp. A new phone booth also replaced one which had been installed on the front facade to the left of the doorway in 1936. Steel vents were placed on the lower portion of the north wall near the tailrace at some undetermined time (BioSystems Analysis 1989; Southern California Edison n.d.).

The original Allis-Chalmers single horizontal overhung impulse water wheel was replaced at the end of 1987 with a new stainless steel wheel (Southern California Edison 1987). The Allis-Chalmers generator and Woodward governor are still in place. The generator has undergone only minor repairs (Southern California Edison 1986a). The governor has seen more work. It was overhauled and modified in 1988. Modifications included replacing the flat leather belts which drove the governor flyballs with a 1/12 horsepower electric motor and adding a conversion kit which adds a 3 horsepower electric motor and replaced leather belts with "V" belts to operate the governor oil pump (Southern California Edison 1988). Other recent maintenance has included replacing the needle and seat which controls the water flow to the water wheel (Southern California Edison 1986b).

15. **Surroundings:**

Scattered buildings: XXXX

16. **Threats to site:**

None known: XXXX

HISTORIC RESOURCES INVENTORY

Kaweah No. 1, Powerhouse - Structure 0101, page 3 of 4

17. Is the structure:

On its original site: XXXX

18. Related features: See attached index to features

SIGNIFICANCE

19. Historical and/or architectural importance:

The architectural style of this structure is simple, pleasing in appearance, and typical of many small west coast hydroelectric Powerhouses of the 1920s. The decision to adopt the neoclassic style was probably a conscious one by the Powerhouse architect. In so choosing this style, he or she continued using of the styles adopted by earlier power plant designers to convey the concept of humankind's conquest of nature.

Changes in major items of internal equipment of the plant have limited their value for study as technological artifacts; however, the general internal scheme of the plant remains intact.

This is an industrial site which one should wish to retain as long as is practicable.

20. Main theme:

Economic/Industrial: XXXX

21. Sources:

BioSystems Analysis, Inc.

1989 Field notes.

Southern California Edison

n.d. Structural record form OD 9-3 200 5-54. Powerhouse - Str. 0101 On file in Building File, SCE Administration building, Kaweah Powerhouse No. 1.

1986a Data sheet entitled Hydro Generation - Southern Division, Revised February 7. On file in Station Manager's Record Book, SCE Administration building, Kaweah Powerhouse No. 1.

HISTORIC RESOURCES INVENTORY

Kaweah No. 1, Powerhouse - Structure 0101, page 4 of 4

- 1986b Maintenance Information Mechanical Work Sheet for Kaweah No. 1, Unit 1. October 6 to 10. On file in Kaweah No. 1 Overhaul Records File, SCE Administration building, Kaweah Powerhouse No. 1.
- 1987 Maintenance Information Mechanical Work Sheet for Kaweah No. 1, Unit 1. November 9 to 20. On file in Kaweah No. 1 Overhaul Records File, SCE Administration building, Kaweah Powerhouse No. 1.
- 1988 Letter from Bill Davis to Dan Morgan. November 1. On file in Kaweah No. 1 Overhaul Records File, SCE Administration building, Kaweah Powerhouse No. 1.

22. Date form prepared: August 15, 1989

KAWEAH HYDROELECTRIC PROJECT HISTORIC RESOURCES INVENTORY



Bldg. 0101, Exterior
Kaweah Powerhouse No. 1
View to SW
Roll 1, Frame 2, 6-27-89



Bldg. 0101, Interior
Kaweah Powerhouse No. 1
View to S
Roll 1, Frame 3, 6-27-89



Bldg. 0101, Control Panel
Kaweah Powerhouse No. 1
View to SE
Roll 1, Frame 4, 6-27-89



Bldg. 0101, Interior
Kaweah Powerhouse No. 1
View to SW
Roll 1, Frame 6, 6-27-89

HISTORIC RESOURCES INVENTORY

IDENTIFICATION

1. **Common name:** Kaweah No. 1, Substation
2. **Historic name:** Kaweah No. 1, Substation
3. **Street or rural address:** State Highway 198 at Hammond
4. **Parcel number:** NA
5. **Present owner:** Southern California Edison Company
2204 Walnut Grove Avenue
Rosemead, CA 91770

Ownership is private: XXXX

6. **Present use:** Hydroelectric substation
Original use: Same

DESCRIPTION

- 7a. **Architectural style:** Industrial
- 7b. **Present physical appearance:**

This outdoor substation contains the Kaweah Powerhouse No. 1 transformers, switches, and a small steel switch house. All rest on a concrete slab and are surrounded by a 6 foot galvanized cyclone fence.

8. **Construction date:** 1928-1929
Factual: XXXX
9. **Architect:** unknown
10. **Builder:** Southern California Edison Company
11. **Approximate property size:** 28' x 96'
12. **Dates of enclosed photographs:** June 27, 1989

HISTORIC RESOURCES INVENTORY

Kaweah No. 1, Substation, page 2 of 3

13. Condition:

Excellent: XXXX

14. Alterations:

The four main 1,000 Kva oil transformers were purchased in 1917 and placed into service at a steam plant in Santa Barbara in 1919. They were transferred to Kaweah No. 1 in 1928 and placed into service in 1929. All underwent major maintenance in 1950, the core and tank flushed of oil and refilled, and bushings rebuilt or replaced. Swiches have also undergone regular maintenance and replacement in-kind as necessary (Southern California Edison n.d.a and n.d.b).

15. Surroundings:

Scattered buildings: XXXX

16. Threats to site:

None known: XXXX

17. Is the structure:

On its original site: XXXX

18. Related features: See attached index to features

SIGNIFICANCE

19. Historical and/or architectural importance:

Although maintenance and replacement in-kind of equipment has altered the substation over time, the four main transformers are the original transformers placed in service at the new Kaweah No. 1 Powerhouse in 1929. There are many examples of original 1910s and 1920s transformers still in use in the west coast power company systems.

20. Main theme:

Economic/Industrial: XXXX

HISTORIC RESOURCES INVENTORY

Kaweah No. 1, Substation, page 3 of 3

21. Sources:

Southern California Edison

n.d.a Structural record form OD 9-3 200 5-52. Substation #1. On file in Building File, Requisitions and Reports, SCE Administration building, Kaweah Powerhouse No. 1.

n.d.b Transformers form OD 9-18 rev. 3M 11-32. Power, Main Transformer Bank. Four separate data sheets identifying four transformers by serial number. On file in Kaweah 1 Overhaul Records binder, SCE Administration building, Kaweah Powerhouse No. 1.

22. Date form prepared: August 15, 1989

**KAWEAH HYDROELECTRIC PROJECT
HISTORIC RESOURCES INVENTORY**

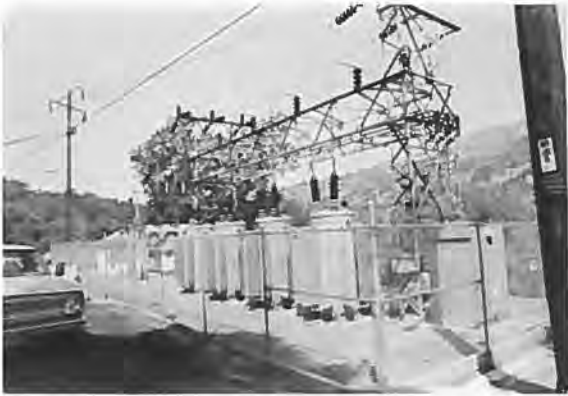

Substation
Kaweah Powerhouse No. 1
View to W
Roll 1, Frame 10, 6-27-89

HISTORIC RESOURCES INVENTORY

IDENTIFICATION

1. **Common name:** Machine shop, Building 0107, at Kaweah No. 1
2. **Historic name:** Machine shop, Building 0107
3. **Street or rural address:** State Highway 198 at Hammond
4. **Parcel number:** NA
5. **Present owner:** Southern California Edison Company
2204 Walnut Grove Avenue
Rosemead, CA 91770

Ownership is private: XXXX

6. **Present use:** Machine shop and store room
Original use: Same

DESCRIPTION

- 7a. **Architectural style:** Industrial utilitarian
- 7b. **Present physical appearance:**

A wood frame, rectangular end gabled structure sheathed in corrugated metal with a metal roof. The structure has an covered porch-like area on the east end and a covered breeze way on the northeast side. It has six standard windows along the south side with a single doorway to the left and a double doorway to the right. It has a single double-hung window on the west end with another single pane window to its left. The structure has a concrete floor. It has been modified at least twice and is in fair condition.

8. **Construction date:** 1927
Estimated: XXXX
9. **Architect:** unknown
10. **Builder:** Southern California Edison Company
11. **Approximate property size:** 16' x 57'

HISTORIC RESOURCES INVENTORY

Machine shop, Building 0107, page 2 of 3

12. Dates of enclosed photographs: June 27, 1989

13. Condition:

Fair: XXXX

14. Alterations:

A 7 foot addition was added on the west end and the roof was extended 10' on the north to make a porch-like addition at an unknown date. In 1951 a cement floor was laid in the portion of the structure used as a blacksmith shop and new mud sills were installed. In 1973 new rain troughs were installed (BioSystems Analysis 1989; Southern California Edison n.d.).

15. Surroundings:

Scattered buildings: XXXX

16. Threats to site:

None known: XXXX

17. Is the structure:

On its original site: XXXX

18. Related features: See attached index to features

SIGNIFICANCE

19. Historical and/or architectural importance:

This structure was probably built just prior to construction of the second Kaweah No. 1 Powerhouse. It is very much like building 0110, which was built in January 1927 (BioSystems Analysis 1989; Southern California Edison 1971). It has no particular historical nor architectural importance.

20. Main theme:

Economic/Industrial: XXXX

HISTORIC RESOURCES INVENTORY

Machine shop, Building 0107, page 3 of 3

21. Sources:

BioSystems Analysis, Inc.

1989 Field notes.

Southern California Edison

n.d. Structural record form OD 9-3 200 5-54. Machine Shop - Store Room. On file in Building File, SCE Administration building, Kaweah Powerhouse No. 1.

1971 Memorandum from E. J. Bresnahan subject Structural Integrity of Edison Company Structures Built Prior to 1933. On file in Files of Joe Fochesato, SCE Administration building, Kaweah Powerhouse No. 1.

22. Date form prepared: August 15, 1989

KAWEAH HYDROELECTRIC PROJECT HISTORIC RESOURCES INVENTORY



Bldg. 0107, Shop
Kaweah Powerhouse No. 1
View to N
Roll 1, Frame 15, 6-27-89



Bldg. 0107, Shop
Kaweah Powerhouse No. 1
View to S
Roll 1, Frame 16, 6-27-89



Bldg. 0107, Shop
Kaweah Powerhouse No. 1
View to NW
Roll 1, Frame 17, 6-27-89

HISTORIC RESOURCES INVENTORY

IDENTIFICATION

1. **Common name:** Cottage, Building 0121, at Kaweah No. 1
2. **Historic name:** Cottage, Building 0121
3. **Street or rural address:** State Highway 198 at Hammond
4. **Parcel number:** NA
5. **Present owner:** Southern California Edison Company
2204 Walnut Grove Avenue
Rosemead, CA 91770

Ownership is private: XXXX

6. **Present use:** Unoccupied
Original use: Supervisory station chief's cottage

DESCRIPTION

- 7a. **Architectural style:** Neoclassic bungalow
- 7b. **Present physical appearance:**

This simple neoclassic style bungalow is entered through a small porchway on its southeast corner. A wood railing gives a hint of the traditional neoclassic enclosed porch. The front (south) side has a nice main window with double hung sidelights. The structure is sheathed in asbestos shingles and has a composition shingle hipped roof. A cement stairway with wood railings leads to the back door on the northeast corner of the cottage. Its interior hardwood floor has experienced water damage.

8. **Construction date:** c. 1927
Estimated: XXXX
9. **Architect:** unknown
10. **Builder:** Southern California Edison Company
11. **Approximate property size:** 38' x 38'

HISTORIC RESOURCES INVENTORY

Cottage, Building 0121, page 2 of 3

12. Dates of enclosed photographs: June 27, 1989

13. Condition:

Fair: XXXX

14. Alterations:

Asbestos shingles replaced the original siding on this building in 1959 (Southern California Edison 1959).

15. Surroundings:

Scattered buildings: XXXX

16. Threats to site:

None known: XXXX

17. Is the structure:

On its original site: XXXX

18. Related features: See attached index to features

SIGNIFICANCE

19. Historical and/or architectural importance:

This building was probably constructed in the mid-1920s as a residence for a Powerhouse employee. It is the only remaining such structure of several which were originally located near Kaweah Powerhouse No. 1. It does not appear, however, to have historical or architectural value of significance.

20. Main theme:

Economic/Industrial: XXXX

HISTORIC RESOURCES INVENTORY

Cottage, Building 0121, page 3 of 3

21. Sources:

BioSystems Analysis, Inc.

1989 Field notes.

Southern California Edison

n.d. Structural record form OD 9-3 200 5-54. Cottage 0121. On file in Building File, SCE Administration building, Kaweah Powerhouse No. 1.

1959 Letter from Robert L. Steele to Clel Stovall. April 13. On file in File 610, Historical Files, SCE Administration building, Kaweah Powerhouse No. 1.

22. Date form prepared: August 15, 1989

**KAWEAH HYDROELECTRIC PROJECT
HISTORIC RESOURCES INVENTORY**



Bldg. 0121, Cottage
Kaweah Powerhouse No. 1
View to NW
Roll 1, Frame 20, 6-27-89



Bldg. 0121, Cottage
Kaweah Powerhouse No. 1
View to SE
Roll 1, Frame 23, 6-27-89

HISTORIC RESOURCES INVENTORY

IDENTIFICATION

1. **Common name:** Carpenter shop, gas house and car garage, Building 0110, at Kaweah No. 1
2. **Historic name:** Storehouse, Building 0110
3. **Street or rural address:** State Highway 198 at Hammond
4. **Parcel number:** NA
5. **Present owner:** Southern California Edison Company
2204 Walnut Grove Avenue
Rosemead, CA 91770

Ownership is private: XXXX

6. **Present use:** Carpenter shop, gas house and garage storage
Original use: Garage and storage

DESCRIPTION

- 7a. **Architectural style:** Industrial utilitarian
- 7b. **Present physical appearance:**

A wood frame, rectangular end gabled structure sheathed in corrugated metal with a metal roof and concrete floor. The basic structure has an addition on the northeast end which gives the building an "L" shape floorplan. It has an overhang breezeway extending along the north side from the addition. Gas pumps are on the southwest end of the building. It has a double sliding garage door, a single sliding garage door and a double metal door on the front (south side). An additional single sliding door has been replaced with a slanted wood grill vent. The east end has a wood frame 6 over 6 window and a wood frame 3 over 3 window. There are 6 standard wood frame windows on the north side and two doorways. It has been modified at least three times and is in fair condition.

8. **Construction date:** 1927

Factual: XXXX

HISTORIC RESOURCES INVENTORY

Carpenter shop, gas house & car garage, Building 0110, page 2 of 3

- 9. **Architect:** unknown
- 10. **Builder:** Southern California Edison Company
- 11. **Approximate property size:** 18' x 48'
- 12. **Dates of enclosed photographs:** June 27, 1989

13. **Condition:**

Fair: XXXX

14. **Alterations:**

An 18' x 18' carpenter shop, a 39" x 60" gas pump house, and a 6' x 8' toilet and lavatory have been added on the structure at unknown dates. The carpenter shop was again enlarged in 1973. The carpenter shop is on the east end of the building, the gas pump on the southwest end, and the toilet and lavatory on the north side adjacent to the portion of the carpenter shop which extends off the main building to the north. A door on the south side was replaced by a wood vent structure at an unknown date. In 1972 new rain troughs were installed (BioSystems Analysis 1989, Southern California Edison n.d.).

15. **Surroundings:**

Scattered buildings: XXXX

16. **Threats to site:**

None known: XXXX

17. **Is the structure:**

On its original site: XXXX

18. **Related features:** See attached index to features

HISTORIC RESOURCES INVENTORY

Carpenter shop, gas house & car garage, Building 0110, page 3 of 3

SIGNIFICANCE

19. Historical and/or architectural importance:

This building was constructed in 1927. It has no particular historical nor architectural importance.

20. Main theme:

Economic/Industrial: XXXX

21. Sources:

BioSystems Analysis, Inc.

1989 Field notes.

Southern California Edison

n.d. Structural record form OD 9-3 200 5-54. Carpenter Shop, Gas House & Car Garage. On file in Building File, SCE Administration building, Kaweah Powerhouse No. 1.

1971 Memorandum from E. J. Bresnahan subject Structural Integrity of Edison Company Structures Built Prior to 1933. On file in Files of Joe Fochesato, SCE Administration building, Kaweah Powerhouse No. 1.

22. Date form prepared: August 15, 1989

**KAWEAH HYDROELECTRIC PROJECT
HISTORIC RESOURCES INVENTORY**



**Bldg. 0128, Storage Shed
Kaweah Powerhouse No. 1
View to NE
Roll 1, Frame 11, 6-27-89**



**Bldg. 0110, Carpenter Shop/Garage
Kaweah Powerhouse No. 1
View to SW
Roll 1, Frame 12, 6-27-89**



**Bldg. 0110, Carpenter Shop/Garage
Kaweah Powerhouse No. 1
View to NNE
Roll 1, Frame 13, 6-27-89**



**Bldg. 0110, Carpenter Shop/Garage
Kaweah Powerhouse No. 1
View to NNW
Roll 1, Frame 14, 6-27-89**

HISTORIC RESOURCES INVENTORY

IDENTIFICATION

1. **Common name:** Garage, Building 0123, at Kaweah No. 1
2. **Historic name:** Garage, Building 0123
3. **Street or rural address:** State Highway 198 at Hammond
4. **Parcel number:** NA
5. **Present owner:** Southern California Edison Company
2204 Walnut Grove Avenue
Rosemead, CA 91770

Ownership is private: XXXX

6. **Present use:** Unoccupied

Original use: Garage next to supervisory station chief's cottage

DESCRIPTION

- 7a. **Architectural style:** Neoclassic style
- 7b. **Present physical appearance:**

This simple neoclassic style garage is entered through an overhung double door on the south end. It has a wood shingle hipped roof. Its walls are sheathed with asbestos shingles. A 6' x'12' slant shingle roof shed is attached to the back (north) and is entered through a single standard size doorway. There is a single pane window in the center of the back wall.

8. **Construction date:** c. 1927

Estimated: XXXX

9. **Architect:** unknown
10. **Builder:** Southern California Edison Company
11. **Approximate property size:** 16' x 16'

HISTORIC RESOURCES INVENTORY

Garage, Building 0123, page 2 of 3

12. Dates of enclosed photographs: June 27, 1989

13. Condition:

Fair: XXXX

14. Alterations:

Asbestos shingles replaced the original siding on this building in 1959 (Southern California Edison 1959).

15. Surroundings:

Scattered buildings: XXXX

16. Threats to site:

None known: XXXX

17. Is the structure:

On its original site: XXXX

18. Related features: See attached index to features

SIGNIFICANCE

19. Historical and/or architectural importance:

This building was probably constructed in the mid-1920s at the same time as cottage 0121. It is the only remaining such garage structure in the vicinity of Kaweah Powerhouse No. 1. It does not appear, however, to have historical or architectural value of significance.

20. Main theme:

Economic/Industrial: XXXX

HISTORIC RESOURCES INVENTORY

Garage, Building 0123, page 3 of 3

21. Sources:

BioSystems Analysis, Inc.

1989 Field notes.

Southern California Edison

1959 Letter from Robert L. Steele to Clel Stovall. April 13. On file in File 610, Historical Files, SCE Administration building, Kaweah Powerhouse No. 1.

22. Date form prepared: August 15, 1989

**KAWEAH HYDROELECTRIC PROJECT
HISTORIC RESOURCES INVENTORY**



Bldg. 0123, Garage
Kaweah Powerhouse No. 1
View to W
Roll 1, Frame 21, 6-27-89



Bldg. 0123, Garage
Kaweah Powerhouse No. 1
View to E
Roll 1, Frame 22, 6-27-89

HISTORIC RESOURCES INVENTORY

IDENTIFICATION

1. **Common name:** Storage shed, Building 0128, at Kaweah No. 1
2. **Historic name:** Storehouse, Building 0110
3. **Street or rural address:** State Highway 198 at Hammond
4. **Parcel number:** NA
5. **Present owner:** Southern California Edison Company
2204 Walnut Grove Avenue
Rosemead, CA 91770

Ownership is private : XXXX

6. **Present use:** Chemical storage shed
Original use: Flume tender's tool shed

DESCRIPTION

- 7a. **Architectural style:** Industrial utilitarian
- 7b. **Present physical appearance:**

A wood frame, 6' x 8' shed with 6" shiplap siding and metal roof, this shed is non-permanent and sits on wood skids.

8. **Construction date:** c. 1920

Estimated: XXXX

9. **Architect:** unknown

10. **Builder:** Southern California Edison Company

11. **Approximate property size:** 6' x 8'

12. **Dates of enclosed photographs:** June 27, 1989 (See photograph form for Powerhouse No.1, Building No. 0110).

HISTORIC RESOURCES INVENTORY

Storage shed, Building 0128, page 2 of 3

13. Condition:

Fair: XXXX

14. Alterations: None known.

15. Surroundings:

Scattered buildings: XXXX

16. Threats to site:

None known: XXXX

17. Is the structure:

Moved: XXXX

18. Related features: See attached index to features

SIGNIFICANCE

19. Historical and/or architectural importance:

This building may have been constructed around 1920 for use as a tool shed on the Kaweah flume; however, this cannot be documented. If it was an original flume tender's tool shed, it has historical significance. It is of no particular architectural importance.

20. Main theme:

Economic/Industrial: XXXX

21. Sources:

BioSystems Analysis, Inc.

1989 Field notes.

HISTORIC RESOURCES INVENTORY

Storage shed, Building 0128, page 3 of 3

Southern California Edison

n.d. Structural record form OD 9-3 200 5-54. Structures 0127, 0128. On file in Building File, SCE Administration building, Kaweah Powerhouse No. 1.

22. **Date form prepared:** August 15, 1989

HISTORIC RESOURCES INVENTORY

IDENTIFICATION

1. **Common name:** Kaweah No. 1, Penstock
2. **Historic name:** Kaweah No. 1, Penstock
3. **Street or rural address:** State Highway 198 at Hammond
4. **Parcel number:** NA
5. **Present owner:** Southern California Edison Company
2204 Walnut Grove Avenue
Rosemead, CA 91770

Ownership is private: XXXX

6. **Present use:** Hydroelectric penstock
Original use: Same

DESCRIPTION

- 7a. **Architectural style:** Industrial
- 7b. **Present physical appearance:**

The Kaweah No. 1 penstock or pressure pipe is 3,340 feet in length and varies from 12 gauge, 24 inch internal dimension diameter steel riveted pipe at the upper end to 5/8 inch thick, 20 inch internal dimension diameter steel pipe at the lower end. The lower 500 feet of the pipe is embedded in concrete and it is anchored to concrete piers carried to bedrock at frequent intervals further up hill. The upper portion is completely covered with dirt.

8. **Construction date:** 1899
Factual: XXXX
9. **Architect:** unknown
10. **Builder:** Mount Whitney Power and Electric Company
11. **Approximate property size:** 10' x 3,340'

HISTORIC RESOURCES INVENTORY

Kaweah No. 1, Penstock, page 2 of 3

12. Dates of enclosed photographs: June 27, 1989

13. Condition:

Good: XXXX

14. Alterations:

This penstock underwent a minor extension when the original Powerhouse was removed and the new one located some 50 feet to the north in 1929 (Southern California Edison 1928). In 1933 plugs were installed on penstock airvalves (Southern California Edison n.d.). In 1967 the upper 300 feet of the 24 inch steel pipe was replaced (Southern California Edison 1967, 1972, and 1984). In 1984 the 50 foot tapered section was replaced and in 1987 the lower 700 feet of the 1929 extension was replaced.

15. Surroundings:

Scattered buildings: XXXX

16. Threats to site:

None known: XXXX

17. Is the structure:

On its original site: XXXX

18. Related features: See attached index to features

SIGNIFICANCE

19. Historical and/or architectural importance:

This is one of the few remaining features of the Kaweah No. 1 Powerhouse system installed in 1899 by the Mt. Whitney Electric Power Company, the first hydroelectric project in the vicinity of Visalia. As such it is a particularly significant industrial artifact, despite the minor changes which it has undergone.

20. Main theme:

Economic/Industrial: XXXX

HISTORIC RESOURCES INVENTORY

Kaweah No. 1, Penstock, page 3 of 3

21. Sources:

BioSystems Analysis, Inc.

1989 Field notes.

Southern California Edison

n.d. Data Sheet. Kaweah #1 Flume and Penstock. On file in Miscellaneous Files, Requisitions and Reports, SCE Administration building, Kaweah Powerhouse No. 1.

1928 Map No. 516988. Existing Buildings and Topography in Vicinity of Proposed New Kaweah No. 1 Powerhouse and Penstock Extension. On file at SCE Administration building, Kaweah Powerhouse No. 1.

1967 General Work Order No. 9008. September 15. On file at SCE Administration building, Kaweah Powerhouse No. 1.

1972 Untitled general description of Kaweah River Project No. 298. June 19. On file in File 059, Historical Files, SCE Administration building, Kaweah Powerhouse No. 1.

1984 Specific Function/Plant Budget Item for Year 1985. May 1. Replace 51 Feet of Upper Penstock Pipe. On file in Requisitions and Reports, Storm Damage Work Orders File at SCE Administration building, Kaweah Powerhouse No. 1.

22. Date form prepared: August 15, 1989

**KAWEAH HYDROELECTRIC PROJECT
HISTORIC RESOURCES INVENTORY**



Penstock
Kaweah Powerhouse No. 1
View to WNW
Roll 2, Frame 31, 6-28-89



Penstock Intake
Kaweah Powerhouse No. 1
View to N
Roll 2, Frame 27, 6-28-89

APPENDIX B

**Historic Resources
Kaweah No. 2**

MAP 3. Kaweah Powerhouse No. 2 Vicinity

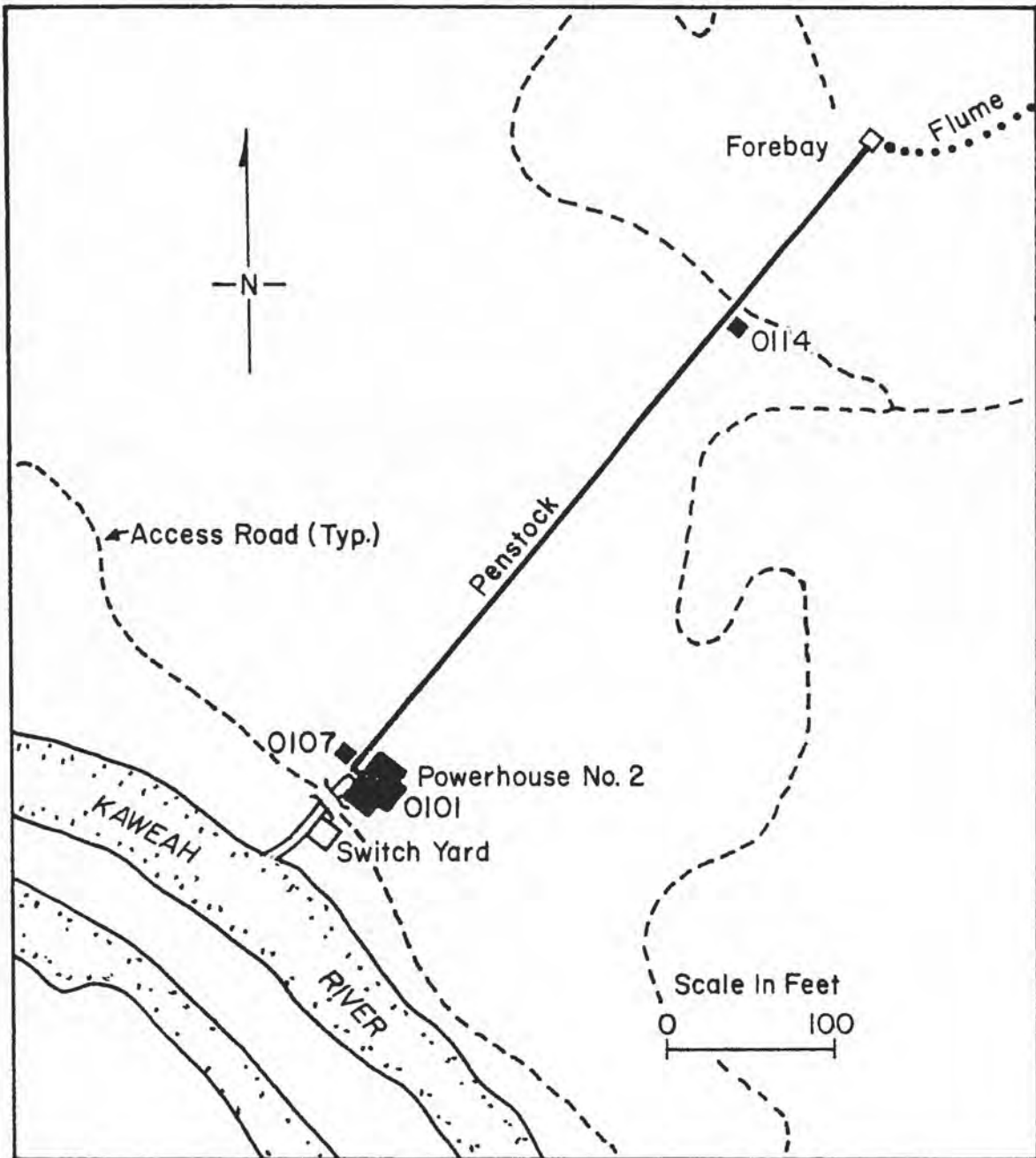

Prepared by BioSystems Analysis, Inc.

HISTORIC RESOURCES INVENTORY

IDENTIFICATION

1. **Common name:** Kaweah No. 2, Powerhouse, Structure 0101
2. **Historic name:** Kaweah No. 2, Powerhouse
3. **Street or rural address:** Off East Road north Kaweah River and of State Highway 198 west of Hammond
4. **Parcel number:** NA
5. **Present owner:** Southern California Edison Company
2204 Walnut Grove Avenue
Rosemead, CA 91770

Ownership is private: XXXX

6. **Present use:** Hydroelectric Powerhouse

Original use: Same

DESCRIPTION

- 7a. **Architectural style:** Industrial
- 7b. **Present physical appearance:**

This industrial Powerhouse is a wood frame structure covered with corrugated iron on a concrete floor. It is approximately 50 feet high at the peak of the clerestory which runs the length of the building. The front of the structure (west) is entered through a large double wood door with a corrugated sheathing on the outside. The entryway is flanked by large 6 over 6 pane double-hung sash windows, and identical windows are above them at the second story level. At the ground floor level, four similar windows are on the south side, and three are on the north side. Three are also on the east end with identical windows above them at the second story level. Two almost ribbon like sets of three windows appear at the second story level on the south side. A single story addition containing batteries and a 2.4 Kva bus is off the south side of the building with a flat roof slanting from the wall of the main structure. It has a window like the other main windows in the structure on its west end.

HISTORIC RESOURCES INVENTORY

Kaweah No. 2, Powerhouse, Structure 0101, page 2 of 4

8. **Construction date:** 1905

Factual: XXXX

9. **Architect:** unknown

10. **Builder:** Mount Whitney Power and Electric Company

11. **Approximate property size:** 22' x 26'

12. **Dates of enclosed photographs:** June 27, 1989

13. **Condition:**

Excellent: XXXX

14. **Alterations:**

The addition off the south side of the Powerhouse was added early in its life, probably before Southern California Edison acquired the property. A chain link fence was placed in front of the Powerhouse in 1935. A cooling duct was installed in the generator pit in 1950, with an extension to the duct in 1975. With the exception of closing in four windows on the center portion of the south wall, no other alterations appear to have been carried out to the building itself (BioSystems Analysis 1989; Southern California Edison n.d.a, 1928).

Originally the Powerhouse contained three main generating units, two of which had been removed before 1913 and replaced with a single, larger unit (Van Norden 1913:17). The third unit was replaced in 1929 by a larger unit. This generating unit, known as Unit No. 2 and comprising a Pelton horizontal shaft reaction turbine, Pelton Type 0-5 governor, and General Electric 2000 Kva generator has undergone regular maintenance and replacement of worn parts. Switches and other electrical equipment have been rewired or replaced over time, while the telephone equipment appears to be original. Generating Unit No. 1, which was installed in 1913, was removed for service in Santa Ana in the 1947 (BioSystems Analysis 1989; Southern California Edison n.d.b, n.d.c, n.d.d, n.d.e, 1984).

15. **Surroundings:**

Scattered buildings: XXXX

HISTORIC RESOURCES INVENTORY

Kaweah No. 2, Powerhouse - Structure 0101, page 3 of 4

16. Threats to site:

None known: XXXX

17. Is the structure:

On its original site: XXXX

18. Related features: See attached index to features

SIGNIFICANCE

19. Historical and/or architectural importance:

The industrial architectural style of this structure is practical, and reflects the limited financial backing which the Mount Whitney Company possessed in its early years. The construction materials are an interesting mix, with wood framing commonly used in industrial structures before 1900 and corrugated iron sheathing and roofing commonly used after 1900. It represents a transitional period in use of construction materials for industrial structures (Rifkind 1980:271-312).

The Powerhouse is constructed in the same style and very close to the same plan as the original Mount Whitney Power and Electric Company Kaweah Powerhouse No. 1, which was torn down in 1929. As such, it is an important remaining artifact of the original Mount Whitney Company system. It is in excellent condition and possesses real integrity, and one should wish to retain the structure for as long as is practicable.

20. Main theme:

Architecture: 1

Economic/Industrial: 2

21. Sources:

BioSystems Analysis, Inc.

1989 Field notes.

HISTORIC RESOURCES INVENTORY

Kaweah No. 2, Powerhouse - Structure 0101, page 4 of 4

Rifkind, Carole

1980 A Field Guide to American Architecture. New York: New American Library.

Southern California Edison

n.d.a Structural record form OD 9-3 200 5-54. Str. 0101 -Powerhouse. On file in Building File, SCE Administration building, Kaweah Powerhouse No. 1.

n.d.b Form OD 9-7 400 11-32. Unit No. 2, Kaweah No. 2. On file in Exciter Files, SCE Administration building, Kaweah Powerhouse No. 1.

n.d.c Form OD 9-7 400 11-32. Kaweah No. 2. On file in Turbine Files, SCE Administration building, Kaweah Powerhouse No. 1.

n.d.d Work Order Jacket No. 2325 for Work Order 5372-8010. Install 10 Position Annunciator Panel. On file in SCE Administration building, Kaweah Powerhouse No. 1.

n.d.e Index, Kaweah No. 2 - Work Orders. On file in General Information File, Requisitions and Reports, SCE Administration building, Kaweah Powerhouse No. 1.

1928 Property Data Book. March 1. On file SCE Headquarters, Rosemead.

1984 Specific Function/Plant Budget Item for Year 1985. Rewire Switch Board, Replace Switchboard Panels. March 7. On file in SCE Administration building, Kaweah Powerhouse No. 1.

Van Norden, Rudolph W.

1913 "System of the Mt. Whitney Power and Electric Company," Journal of Electricity, Power and Gas, 31 (December 27), 5-36.

22. **Date form prepared:** June 27, 1989

KAWEAH HYDROELECTRIC PROJECT HISTORIC RESOURCES INVENTORY



Bldg. 0101, Interior
Kaweah Powerhouse No. 2
View to NE
Roll 1, Frame 24, 6-27-89



Bldg. 0101, Generator Floor
Kaweah Powerhouse No. 2
View to W
Roll 1, Frame 26, 6-27-89



Bldg. 0101, Control Panel
Kaweah Powerhouse No. 2
View to NE
Roll 1, Frame 27, 6-27-89



Bldg. 0101
Kaweah Powerhouse No. 2
View to N
Roll 1, Frame 30, 6-27-89

HISTORIC RESOURCES INVENTORY

IDENTIFICATION

1. **Common name:** Kaweah No. 2, Substation
 2. **Historic name:** Kaweah No. 2, Substation
 3. **Street or rural address:** Off East Road north Kaweah River and of State Highway 198 west of Hammond
 4. **Parcel number:** NA
 5. **Present owner:** Southern California Edison Company
2204 Walnut Grove Avenue
Rosemead, CA 91770
- Ownership is private:** XXXX
6. **Present use:** Hydroelectric substation
- Original use:** Same

DESCRIPTION

- 7a. **Architectural style:** Industrial
 - 7b. **Present physical appearance:**

This outdoor substation contains the Kaweah Powerhouse No. 2 transformers. They rest on a concrete slab and are surrounded by a 8 foot galvanized cyclone fence.
 8. **Construction date:** 1925
- Factual:** XXXX
9. **Architect:** unknown
 10. **Builder:** Southern California Edison Company
 11. **Approximate property size:** 28' x 96'
 12. **Dates of enclosed photographs:** June 27, 1989

HISTORIC RESOURCES INVENTORY

Kaweah No. 2, Substation, page 2 of 3

13. Condition:

Excellent: XXXX

14. Alterations:

The main 750 Kva oil transformers were purchased in 1925 and placed into service at Kaweah No. 2 the same year. All underwent major maintenance in 1947, the core and tank flushed of oil and refilled, and bushings rebuilt or replaced. Swiches have also undergone regular maintenance and replacement in-kind as necessary. In 1947 the transformers were moved from their original location north of the Powerhouse to their present location in front of the Powerhouse. The 8 foot cyclone fence was installed in 1975, replacing a 6 foot fence (Southern California Edison n.d.a, n.d.b, n.d.c).

15. Surroundings:

Scattered buildings: XXXX

16. Threats to site:

None known: XXXX

17. Is the structure:

Moved: XXXX

18. Related features: See attached index to features

SIGNIFICANCE

19. Historical and/or architectural importance:

Although maintenance and replacement in-kind of equipment has altered the substation over time, the four main transformers have been in service at the Kaweah No. 2 Powerhouse since 1925.

20. Main theme:

Economic/Industrial: XXXX

HISTORIC RESOURCES INVENTORY

Kaweah No. 2, Substation, page 3 of 3

21. Sources:

Southern California Edison

- n.d.a Structural record form OD 9-3 1500 3-31. No Structure Letter, 66 Kv.-Substation. On file in Building File, Requisitions and Reports, SCE Administration building, Kaweah Powerhouse No. 1.
- n.d.b Transformers form OD 9-18 rev. 3M 11-32. Power, Main Transformer Bank, Kaweah # 2. Four separate data sheets identifying four transformers by serial number. On file in Kaweah 1 Overhaul Records binder, SCE Administration building, Kaweah Powerhouse No. 1.
- n.d.c Index, Kaweah No. 2 - Work Orders. On file in General Information File, Requisitions and Reports, SCE Administration building, Kaweah Powerhouse No. 1.

22. Date form prepared: August 15, 1989

**KAWEAH HYDROELECTRIC PROJECT
HISTORIC RESOURCES INVENTORY**



Substation
Kaweah Powerhouse No. 2
View to SW
Roll 1, Frame 31, 6-27-89

APPENDIX C

**Historic Resources
Kaweah No. 3**

MAP 4. Kaweah Powerhouse No. 3 Vicinity

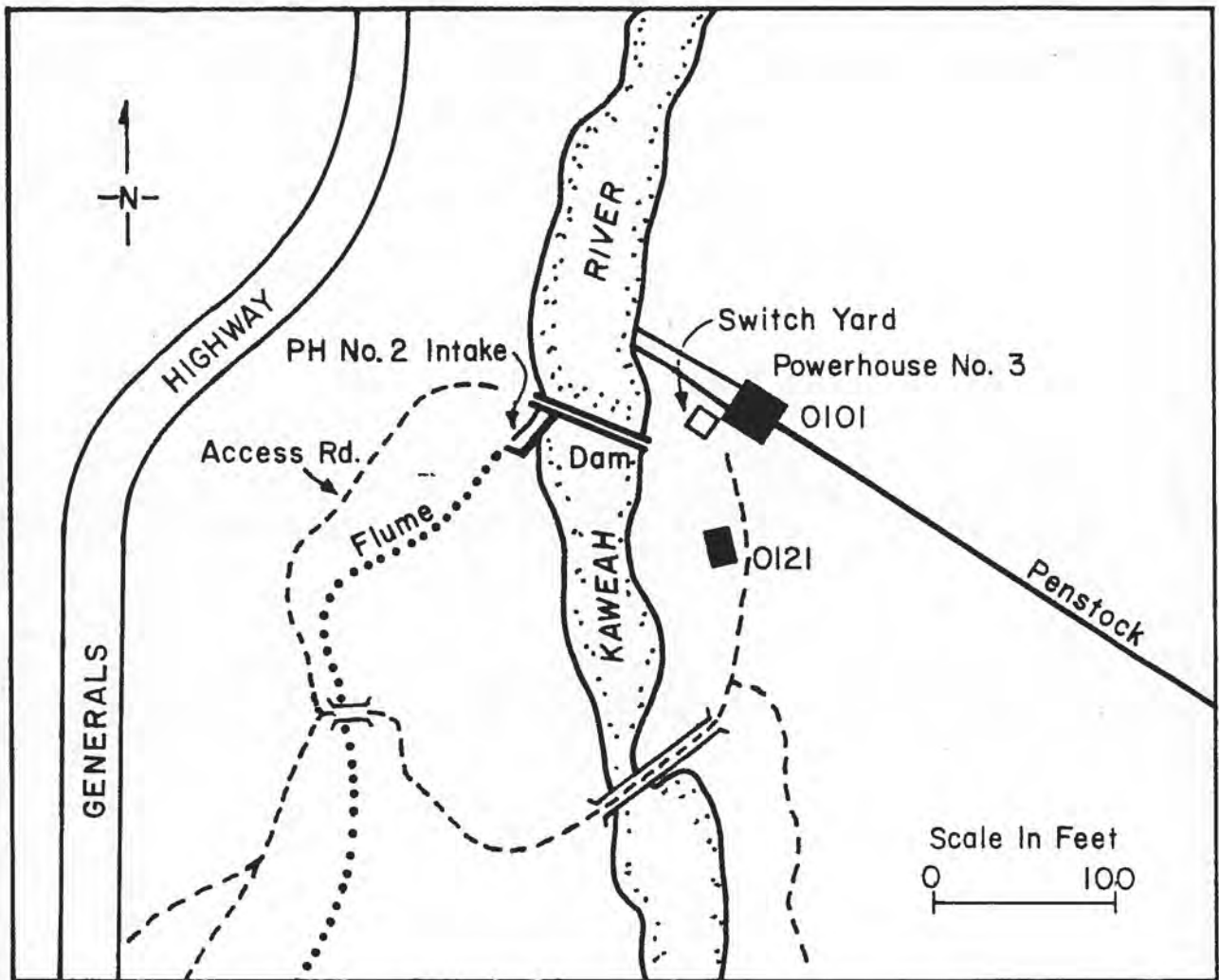

HISTORIC RESOURCES INVENTORY

IDENTIFICATION

1. **Common name:** Kaweah No. 3, Powerhouse, Structure 0101
2. **Historic name:** Kaweah No. 3, Powerhouse
3. **Street or rural address:** South of State Highway 198 and the Kaweah River east of Hammond
4. **Parcel number:** NA
5. **Present owner:** Southern California Edison Company
2204 Walnut Grove Avenue
Rosemead, CA 91770

Ownership is private: XXXX

6. **Present use:** Hydroelectric Powerhouse

Original use: Same

DESCRIPTION

- 7a. **Architectural style:** Industrial
- 7b. **Present physical appearance:**

This industrial Powerhouse is a reinforced concrete structure divided on the inside by a transverse wall into a main operating room and high tension section with an office space. The flat concrete roof overhangs the front of the building. Four pilasters, one on each corner and two spaced evenly across the front (west) facade rise from a belt line marking the floor level. This main facade has a 10 foot x 12 foot roll-up metal door with a chain link gate on the left side. An standard entryway door is in the center of the facade, flanked by large windows composed of 16 small panes surrounding an enclosed area where a larger one over one pane once existed. Two identical windows mounted side by side are on the right end of the facade. Just below the roof line are six smaller windows in sets of two. Similar industrial type fenestration is on all other sides of the building. The building is approximately 35 feet high.

8. **Construction date:** 1913

Factual: XXXX

HISTORIC RESOURCES INVENTORY

Kaweah No. 3, Powerhouse, Structure 0101, page 2 of 4

9. **Architect:** unknown
10. **Builder:** Mount Whitney Power and Electric Company
11. **Approximate property size:** 50' x 50'
12. **Dates of enclosed photographs:** June 27, 1989
13. **Condition:**

Excellent: XXXX

14. **Alterations:**

Virtually no alterations have been made to the powerhouse, with the exception of replacing the large one over one windows on the main facade with solid material (BioSystems Analysis 1989; Southern California Edison n.d.a).

The Powerhouse contains the original Pelton-Doble single overhung impulse water wheels and 1,750 Kva Westinghouse generators, all purchased for installation in 1912. The generator for Unit No. 1 has been rewound three times and has had coils replaced once, whereas the Unit No. 2 generator has had coils replaced several times but never been rewound. The Unit No. 1 water wheel has had the needle and nozzle replaced, buckets replaced, and had its Pelton governor replaced with an electrically operated needle valve load control. In 1958 a new wheel was installed in this unit. The Unit No. 2 water wheel has had similar repairs and replacement of parts; however, the Pelton Type 0-5 governor is still in place (BioSystems Analysis 1989; Southern California Edison n.d.b, n.d.c, 1928, 1958, 1986).

15. **Surroundings:**

Scattered buildings: XXXX

16. **Threats to site:**

None known: XXXX

17. **Is the structure:**

On its original site: XXXX

HISTORIC RESOURCES INVENTORY

Kaweah No. 3, Powerhouse - Structure 0101, page 3 of 4

18. Related features: See attached index to features

SIGNIFICANCE

19. Historical and/or architectural importance:

The industrial architectural style of this structure is attractive, and a good representation of early 20th century reinforced concrete construction. It represents increased prosperity for the Mount Whitney Power and Electric Company, when compared to the building materials and style used in Kaweah plants number one and two. The integrity of the structure is excellent and in fine condition, and for the most part it contains the original Powerhouse equipment. One should wish to retain the structure for as long as is practicable.

20. Main theme:

Architecture: 1

Economic/Industrial: 2

21. Sources:

BioSystems Analysis, Inc.

1989 Field notes.

Southern California Edison

n.d.a Structural record form OD 9-3 1500 3-31. Struct. 0101 - Powerhouse. On file in Building File, SCE Administration building, Kaweah Powerhouse No. 1.

n.d.b Form OD 9-19 rev. 250 11-32. Turbines, Impulse, Unit No. 1, Kaweah No. 3. On file in Turbine Files, SCE Administration building, Kaweah Powerhouse No. 1.

n.d.c Form OD 9-19 rev. 250 11-32. Turbines, Impulse, Unit No. 2, Kaweah No. 3. On file in Turbine Files, SCE Administration building, Kaweah Powerhouse No. 1.

HISTORIC RESOURCES INVENTORY

Kaweah No. 3, Powerhouse - Structure 0101, page 4 of 4

- 1928 Property Data Book. March 1. On file SCE Headquarters, Rosemead.
- 1958 General Work Order No. 2226. Purchase and install one cast steel integral water wheel for Unit No. 1. October 9. On file in SCE Administration building, Kaweah Powerhouse No. 1.
- 1986 Data sheet. Hydro Generation - Southern Division. Revised February 7. On file in Station Manager's Record Book in SCE Administration building, Kaweah Powerhouse No. 1.

22. Date form prepared: August 15, 1989

KAWEAH HYDROELECTRIC PROJECT HISTORIC RESOURCES INVENTORY



Bldg. 0101, Exterior
Kaweah Powerhouse No. 3
View to SE
Roll 2, Frame 2, 6-27-89



Bldg. 0101, Generator Floor
Kaweah Powerhouse No. 3
View to NNW
Roll 2, Frame 3, 6-27-89



Bldg. 0101, Generator Floor
Kaweah Powerhouse No. 3
View to N
Roll 2, Frame 4, 6-27-89



Bldg. 0101, Generator Floor
Kaweah Powerhouse No. 3
View to S
Roll 2, Frame 5, 6-27-89

KAWEAH HYDROELECTRIC PROJECT HISTORIC RESOURCES INVENTORY

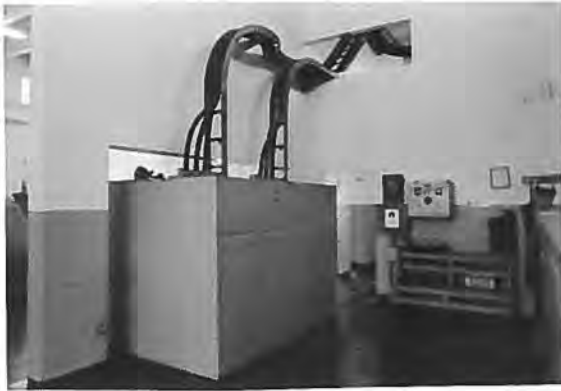

Bldg. 0101, Buss System
Kaweah Powerhouse No. 3
View to S
Roll 2, Frame 7, 6-27-89

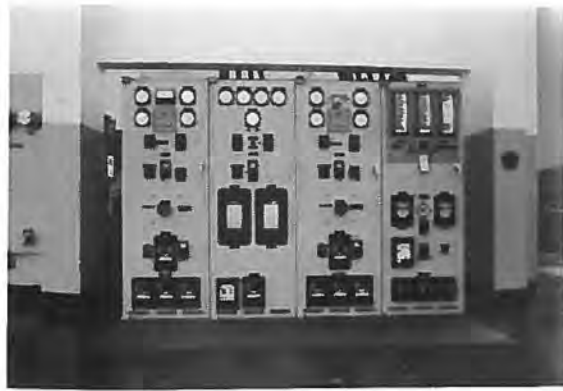

Bldg. 0101, Control Panel
Kaweah Powerhouse No. 3
View to SW
Roll 2, Frame 8, 6-27-89



Bldg. 0101, Tailrace and Substation
Kaweah Powerhouse No. 3
View to SW
Roll 2, Frame 9, 6-27-89



Bldg. 0101
Kaweah Powerhouse No. 3
View to E
Roll 2, Frame 13, 6-27-89

HISTORIC RESOURCES INVENTORY

IDENTIFICATION

1. **Common name:** Marble Fork Conduit, at Kaweah No. 3
2. **Historic name:** Kaweah No. 3, Marble Fork Conduit
3. **Street or rural address:** East of and parallel to Marble Creek Fork of the Kaweah River east of Hammond
4. **Parcel number:** NA
5. **Present owner:** Southern California Edison Company
2204 Walnut Grove Avenue
Rosemead, CA 91770

Ownership is private: XXXX

6. **Present use:** Water conduit

Original use: Same

DESCRIPTION

- 7a. **Architectural style:** Cement lined ditch, reinforced slab conduit, and inverted siphon
- 7b. **Present physical appearance:**

This 5,000 foot conduit is comprised of a cement lined ditch, slab construction, and an inverted siphon. It stretches from a small cement diversion dam on Marble Fork which diverts water into a simple masonry intake on the east side of Marble Fork. Some of the early portion of the conduit is of slab construction, like that of the Middle Fork conduit. Thence water flows 3,015 feet through the conduit, terminating in a sandbox and reinforced concrete overflow siphon. This terminus also acts as the head-box for the inverted siphon. The 1,085 foot siphon is made of 48 inch riveted steel pipe. It has a static head of 125 feet. The siphon crosses the bed of the Middle Fork of the Kaweah River and terminates at the Middle Fork Conduit. A concrete bed is laid over the siphon where it crosses the river to permit the river water to flow smoothly over the pipe without damaging it.

8. **Construction date:** 1912-1913

Factual: XXXX

HISTORIC RESOURCES INVENTORY

Kaweah No. 3, Marble Fork Conduit, page 2 of 3

9. **Architect:** unknown
10. **Builder:** Mount Whitney Power and Electric Company
11. **Approximate property size:** 5,000' x 10'
12. **Dates of enclosed photographs:** June 27, 1989

13. **Condition:**

Excellent: XXXX

14. **Alterations:**

Virtually no alterations have been made to the conduit or siphon since its construction, although regular repairs to washed out and leaking sections have been made. At the intake the dam and intake structures underwent repairs in 1968 (BioSystems Analysis 1989; Southern California Edison n.d.a, 1968).

15. **Surroundings:**

Open land: XXXX

16. **Threats to site:**

None known: XXXX

17. **Is the structure:**

On its original site: XXXX

18. **Related features:** See attached index to features

SIGNIFICANCE

19. **Historical and/or architectural importance:**

This conduit possesses particular technological and historical importance partly because of the few sections of slab construction in it and its siphon section, and because it is an integral part of the distinctive Kaweah No. 3 Middle Fork conduit. The construction techniques and materials used in the overall Kaweah No. 3 hydroelectric power conduit system truly are unique. This investigator knows of no

HISTORIC RESOURCES INVENTORY

Kaweah No. 3, Marble Fork Conduit, page 3 of 3

other such concrete slab construction in California. That the conduit still is serviceable and in excellent condition is a tribute to its designers and builders. The entire system, comprising the Marble Fork conduit and siphon and the Middle Fork conduit should be nominated for the National Register of Historic Places.

20. Main theme:

Economic/Industrial: XXXX

21. Sources:

BioSystems Analysis, Inc.

1989 Field notes.

Southern California Edison

n.d. Data sheet. Water Conduits-Kaweah No. 3. On file in Water Conduits, Requisitions and Reports, SCE Administration building, Kaweah Powerhouse No. 1.

U.S. Geological Survey

1923 Hydroelectric Power Systems of California and Their Extensions into Oregon and Nevada, by Frederick Hall Fowler. Water Supply Paper 493. Washington D.C.: Government Printing Office.

Van Norden, Rudolph W.

1913 "System of the Mt. Whitney Power and Electric Company," Journal of Electricity, Power and Gas, 31 (December 27), 5-36.

22. Date form prepared: August 15, 1989

KAWEAH HYDROELECTRIC PROJECT HISTORIC RESOURCES INVENTORY



Marble Fork Flume
Kaweah Powerhouse No. 3
View to NNW
Roll 2, Frame 16, 6-27-89



Marble Fork Diversion and Flume
Kaweah Powerhouse No. 3
View to NE
Roll 2, Frame 20, 6-27-89

HISTORIC RESOURCES INVENTORY

IDENTIFICATION

1. **Common name:** Middle Fork Conduit, at Kaweah No. 3
2. **Historic name:** Kaweah No. 3, Middle Fork Conduit
3. **Street or rural address:** South of and parallel to the Middle Fork of the Kaweah River east of Hammond
4. **Parcel number:** NA
5. **Present owner:** Southern California Edison Company
2204 Walnut Grove Avenue
Rosemead, CA 91770

Ownership is private: XXXX

6. **Present use:** Water conduit

Original use: Same

DESCRIPTION

- 7a. **Architectural style:** Intake, reinforced cement slab, cement ditch, forebay, and penstock
- 7b. **Present physical appearance:**

This 20,000 foot conduit is comprised of single and double slab reinforced concrete canal. It stretches from a small cement diversion dam which diverts water into a simple masonry intake on the south side of the Middle Fork of the Kaweah River. Thence water flows through the conduit of which 15,700 feet are constructed of concrete slab.

Portions of the conduit are concrete lined ditch. Slabs are "L" shaped, the longer leg of the slab forming the side while the shorter leg is an unfinished section of the bottom of the canal. Each slab is 12 feet long and approximately 5 feet high with a width of 4 inches at the bottom, tapering to 3 inches at the top. Slabs are reinforced with wire fabric and two 5/16 inch twisted iron bars running lengthwise. Where possible the bottom of the conduit is a slab poured directly on an earthen base; however, portions of the conduit's bottom is comprised of independent slabs supported by masonry and rubble buttresses.

HISTORIC RESOURCES INVENTORY

Kaweah No. 3, Middle Fork Conduit, page 2 of 5

The conduit receives additional water from an inverted siphon across the Kaweah River valley which is fed by water from the Marble Fork conduit. A reinforced concrete overflow siphon is located at the Kaweah No. 3 forebay reservoir. The forebay is 315 foot long by 15 to 70 foot wide, excavated on the point of a hill which was first leveled off. It has a capacity of of 11 acre feet of water.

From the forebay water flows through in a 3,151 foot penstock or pressure pipe comprised of riveted steel ranging from 42 to 36 inches in diameter and 3/16 to 1/2 inches thick. It has a static head of about 775 feet.

8. **Construction date:** 1912-1913

Factual: XXXX

9. **Architect:** unknown

10. **Builder:** Mount Whitney Power and Electric Company

11. **Approximate property size:** 20,000' x 10'

12. **Dates of enclosed photographs:** June 28, 1989

13. **Condition:**

Excellent: XXXX

14. **Alterations:**

A few alterations have been made to the conduit since its construction, including regular repairs to washed out and leaking sections. The canals were lined with 1/2" gunite and reinforced in 1947. The flumes were lined with an 1/2" layer of reinforced gunite on the walls and bottom in 1946. At the intake the dam and intake structures underwent repairs in 1968, and at the same time retaining walls along the penstock were repaired (BioSystems Analysis 1989; Southern California Edison n.d.a, 1968).

15. **Surroundings:**

Open land: XXXX

HISTORIC RESOURCES INVENTORY

Kaweah No. 3, Middle Fork Conduit, page 3 of 5

16. Threats to site:

None known: XXXX

17. Is the structure:

On its original site: XXXX

18. Related features: See attached index to features

SIGNIFICANCE

19. Historical and/or architectural importance:

This single and double slab reinforced conduit is of particular technological and historical importance. When it was built, Rudolph Van Norden described it in The Journal of Electricity, Power and Gas, the west coast's principal electrical industry technical journal, as having "a number of points of interest to engineers, as it is quite unique in its design and method of construction" (Van Norden 1913: 8-9; U.S. Geological Survey, 1923:657-658).

The conduit was excavated by hand and with the aid of a steam shovel. Wherever a ditch could be used without slabs to build the walls up, a berm was left, and these sections were lined with 3 inch thick concrete. The first 3,300 feet of the canal is 6 feet wide inside and 3 feet deep and ends at the junction with the Marble Fork Siphon. It is built of side slabs with a reinforced concrete bottom slab supported at the joints (every 12 feet) by masonry piers. On the remainder of the conduit, wherever the ground surface offered good support on the inner side, the inner side and earth bottom were lined with concrete and single slab construction was used to form the outer wall. Where the ground surface did not offer support, an inner wall slab was also used.

Throughout the conduit slabs were preformed at a space between Marble Fork and the Middle Fork of the Kaweah. Gravel and sand were obtained from the stream beds nearby and crushed in a plant erected for the purpose. Slabs were poured into wooden forms. The "L" shaped slabs were then transported to the site on a rail track from the slab yard to the conduit and then along the conduit floor. A gasoline engine pulled slabs loaded 2 each on small double truck cars and were unloaded at the installation site by a portable derrick mounted on a car pulled behind the slab car.

HISTORIC RESOURCES INVENTORY

Kaweah No. 3, Middle Fork Conduit, page 4 of 5

When the slabs were set in place the bottom was filled in between the "L" branches of the slabs and finished. Slabs were placed end to end, and the protruding portion of the two longitudinal iron reinforcing bars in each slab were bent outward and twisted together. The joints were completed by pouring a concrete pilaster on to a prepared 2 foot square foundation. Pilasters were poured into a metal form which went over the joint and reinforcing bars. All bends in the conduit were made at slab joining points, and the pilaster was poured so as to take up any angle between the slab ends.

The construction techniques and materials used in this hydroelectric power conduit system truly are distinctive. This investigator knows of no other such concrete slab construction in California. That the conduit still is serviceable and in excellent condition is a tribute to its designers and builders. It is an engineer site which should be nominated for the National Register of Historic Places.

20. Main theme:

Economic/Industrial: XXXX

21. Sources:

BioSystems Analysis, Inc.

1989 Field notes.

Southern California Edison

n.d. Data sheet. Water Conduits-Kaweah No. 3. On file in Water Conduits, Requisitions and Reports, SCE Administration building, Kaweah Powerhouse No. 1.

1968 Report of Completion of General Work Order No. 9004. Repair Middle Fork Diversion Dam and Sandbox. On file at SCE Administration building, Kaweah Powerhouse No. 1.

U.S. Geological Survey

1923 Hydroelectric Power Systems of California and Their Extensions into Oregon and Nevada, by Frederick Hall Fowler. Water Supply Paper 493. Washington D.C.: Govt. Printing Office.

HISTORIC RESOURCES INVENTORY

Kaweah No. 3, Middle Fork Conduit, page 5 of 5

Van Norden, Rudolph W.

1913 "System of the Mt. Whitney Power and Electric Company," Journal of Electricity, Power and Gas, 31 (December 27), 5-36.

22. Date form prepared: August 15, 1989

KAWEAH HYDROELECTRIC PROJECT HISTORIC RESOURCES INVENTORY



Middle Fork Flume
Kaweah Powerhouse No. 3
View to NE
Roll 2, Frame 17, 6-27-89



Middle Fork Diversion
Kaweah Powerhouse No. 3
View to SSE
Roll 2, Frame 23, 6-28-89



Penstock
Kaweah Powerhouse No. 3
View to SE
Roll 2, Frame 25, 6-28-89

APPENDIX D

Eagle, Franklin, Monarch and Crystal Lakes

HISTORIC RESOURCES INVENTORY

IDENTIFICATION

1. **Common name:** Eagle Lake
2. **Historic name:** Eagle Lake
3. **Street or rural address:** Eagle Creek, a tributary to the east fork of the Kaweah River
4. **Parcel number:** NA
5. **Present owner:** Southern California Edison Company
2204 Walnut Grove Avenue
Rosemead, CA 91770

Ownership is private: XXXX

6. **Present use:** Water storage

Original use: Same

DESCRIPTION

- 7a. **Architectural style:** Gravity dam, rubble/masonry type
- 7b. **Present physical appearance:**

This simple dam remains as originally constructed in 1904. It is built up of stone set in cement mortar and capped with stone set in concrete. The dam is 286 feet long and 5 feet wide, and has an additional 10" wide concrete wall on the upstream side of the dam which rises vertically to a levee 2 1/2 feet below the dam's top edge. This concrete wall, however, only covers approximately 2/3 of the dam face. A rock pier 12'x13'x14' high anchors an 8" outlet and valve near the middle of the dam's upstream face. There are three spillways located on the dam. The lowest at elevation 9995.82 feet is 14 feet wide. The two other spillways are at elevations 9996.32 feet and 9998.62 feet, and are 12 and 14 feet wide respectively. Much of this dam is less than 3 feet above the local topography and the dam's crest elevation of 10,000 feet is only 14.25 feet above its 8 inch gate valve. The dam produces a reservoir covering 21 acres and stores 256 acre feet at maximum capacity.

HISTORIC RESOURCES INVENTORY

Eagle Lake page 2 of 3

8. Construction date: 1904

Factual: XXXX

9. Architect: unknown

10. Builder: Mt. Whitney Power Company

11. Approximate property size: 2300' x 900'

12. Dates of enclosed photographs: August 4, 1943; 1985

13. Condition:

Excellent: XXXX

14. Alterations:

This dam, subject to yearly inspections, has been maintained with the same techniques and materials as were used in its original construction. These repairs were undertaken as they are today on an "as needed" basis. Typically, as with all high altitude dams of this type, most of the maintenance has been the removal and replacement of loose mortar on the dam's upstream face.

15. Surroundings:

No structures: XXXX

16. Threats to site:

None known: XXXX

17. Is the structure:

On its original site: XXXX

18. Related features: See attached index to features

HISTORIC RESOURCES INVENTORY

Eagle Lake page 3 of 3

SIGNIFICANCE

19. Historical and/or architectural importance:

The Eagle Lake Dam is one of the original remaining elements of the Kaweah No. 1 / 3 generation project. The dam has been little modified since construction in 1904 and has been maintained generally with in kind materials. The simple construction of the dam is functional although it is not distinctive either from an architectural or engineering perspective.

20. Main theme:

Economic/Industrial: XXXX

21. Sources:

BioSystems Analysis, Inc.

1989 Field notes. Personal Communications with Dan Morgan

Southern California Edison

n.d. Kaweah No. 1 Misc. File #5-A-1. On file in Requisitions and Reports, SCE Admin. Bldg., Kaweah Powerhouse No. 1.

1909 Stipulation for Judgement, Jan. 19, 1909, In the Superior Court of the County of Tulare, State of California. On file in Historical File 700, SCE Admin. Office, Kaweah Powerhouse No. 1.

1930 Plan, Elevation and Sections of Eagle Lake Dam. SCE drawing 112534-2, File 700. On file in Historical files, SCE Admin. Office, Kaweah Powerhouse No. 1.

1951 Mineral Lakes Hydraulic Data, File 700. On file in Historical Files, SCE Admin. Office, Kaweah Powerhouse No. 1.

1975 Exhibit K, Kaweah Project No. 298, SCE Drawing 5150184. On file at SCE Admin. Office, Kaweah Powerhouse No. 1.

1975 Exhibit L, Kaweah No. 1, Mineral King Area Dams Project No. 298, SCE Drawing 5148898. On file at Kaweah Powerhouse No. 1.

22. Date form prepared: August 15, 1989

KAWEAH HYDROELECTRIC PROJECT HISTORIC RESOURCES INVENTORY



Eagle Lake Dam
SCE Historical Photo Album
View to W
8-4-43



Eagle Lake Dam
SCE Historical Photo Album
View to S
7-21-33



Eagle Lake Dam
Kaweah Powerhouse No. 1
View to SW
Courtesy, Dan Morgan, ca. 1985

**KAWEAH HYDROELECTRIC PROJECT
HISTORIC RESOURCES INVENTORY**



Eagle Lake Dam
Kaweah Powerhouse No. 1
View to W
Courtesy, Dan Morgan, ca. 1985

HISTORIC RESOURCES INVENTORY

IDENTIFICATION

1. **Common name:** Franklin Lake
2. **Historic name:** Lady Franklin Lakes
3. **Street or rural address:** Franklin Creek, a tributary of the east fork of the Kaweah River
4. **Parcel number:**
5. **Present owner:** Southern California Edison Company
2204 Walnut Grove Avenue
Rosemead, CA 91770

Ownership is private: XXXX

6. **Present use:** Reservoir
Original use: Same

DESCRIPTION

- 7a. **Architectural style:** Gravity dam, rubble/masonry type
- 7b. **Present physical appearance:**

The Franklin Lake Dam is a buttressed dam 393.65 feet long having a main wall 4 feet thick. Both buttressed and main dam are layed up of native rock with mortar, and capped with concrete. Loose rock till is placed between the buttresses. The dams crest elevation is 10,316.1 feet and its 8" gate valves' outlet pipe is at 10,295.1 feet elevation. The spillway is 25 feet wide, at 10,316 feet elevation, giving the dam a storage capacity of 1186 acre feet and covering 30 acres. The dam's maximum height is 20.9 feet at a point over its 8" gate valve.

8. **Construction date:** 1905
Factual: XXXX
9. **Architect:** unknown
10. **Builder:** Mt. Whitney Power Company

HISTORIC RESOURCES INVENTORY

Franklin Lake, page 2 of 3

11. **Approximate property size:** 900' x 2400'
12. **Dates of enclosed photographs:** August 4, 1943; 1985

13. **Condition:**

Excellent: XXXX

14. **Alterations:**

This dam, subject to yearly inspections, has been repaired with the same techniques and materials as were used in its original construction in 1905 until about 1955. In 1955 the upstream face was repaired with a coating of Asbestile and perforated asphalt impregnated paper between layers. In 1948 the 8" outlet pipe was extended on the Gate Stems. As is typical on high altitude type dams repairs to the dam mortar is done on an "as needed" basis.

15. **Surroundings:**

No structures present: XXXX

16. **Threats to site:**

None known: XXXX

17. **Is the structure:**

On its original site: XXXX

18. **Related features:** See attached index to features

SIGNIFICANCE

19. **Historical and/or architectural importance:**

The Franklin Lake Dam is one of the original remaining elements of the Kaweah No. 3 generation project. The dam has been little modified since construction in 1905 and has been maintained generally with in kind materials. The simple construction of the dam is functional although it is not distinctive either from an architectural or engineering perspective

HISTORIC RESOURCES INVENTORY

Franklin Lake, page 3 of 3

20. Main theme:
Economic/Industrial: XXXX

21. Sources:

BioSystems Analysis, Inc.

1989 Field notes. Personal communications with Dan Morgan.

Southern California Edison

n.d. Kaweah No. 1 Misc. On file in File 5-A-1, Requisitions and Reports, SCE Admin. Bldg., Kaweah No. 1 Powerhouse.

1909 Stipulation for Judgement, Jan 19, 1909, Superior Court of the County of Tulare, State of California, SCE File 700. On file in Historical Files, SCE Admin. Office, Kaweah Powerhouse No. 1.

1930 Plan, Elevation and Section of Franklin Lake Dam, SCE Drawing 1103461, File 700. On file in Historical Files, SCE Admin. Office, Kaweah Powerhouse No. 1.

1951 Mineral King Lakes Hydraulic Data, SCE File 700. Filed in Historical Files, SCE Admin. Office, Kaweah Powerhouse No. 1.

1957 Northern Hydro Division - Inspection of Franklin Lake Dam, Kaweah No. 1 Project File 700. On file in Historical Files, SCE Admin. Office, Kaweah Powerhouse No. 1.

1975 Exhibit K, Kaweah Project No. 298, SCE Drawing 5150184. On file at SCE Admin. Office, Kaweah Powerhouse No. 1.

1975 Exhibit L, Kaweah No. 1 Mineral King Dams, Project 298, SCE Drawing 5148898. On file at SCE Admin. Office, Kaweah Powerhouse No. 1.

22. Date form prepared: August 15, 1989

KAWEAH HYDROELECTRIC PROJECT HISTORIC RESOURCES INVENTORY



Franklin Lake Dam
SCE Historical Photo Album
View to NE
8-4-43



Franklin Lake Dam
Kaweah Powerhouse No. 1
View to SSW
Courtesy, Dan Morgan, ca. 1985



Franklin Lake Dam
Kaweah Powerhouse No. 1
View to NNE
Courtesy, Dan Morgan, ca. 1985

HISTORIC RESOURCES INVENTORY

IDENTIFICATION

1. **Common name:** Monarch Lake
2. **Historic name:** Upper Monarch Lake
3. **Street or rural address:** Monarch Creek, a tributary of the east fork of the Kaweah River
4. **Parcel number:** NA
5. **Present owner:** Southern California Edison Company
2204 Walnut Grove Avenue
Rosemead, CA 91770

Ownership is private: XXXX

6. **Present use:** Storage reservoir

Original use: Same

DESCRIPTION

- 7a. **Architectural style:** Gravity dam, rubble/masonry type

- 7b. **Present physical appearance:**

The Monarch Lake Dam is a buttressed dam 263 feet in length. The dam wall and buttresses (both approximately 2 feet thick) are laid up from native rock with mortar, and capped with concrete. Loose rock fill is placed between the buttresses on the downstream dam face. The dam crest elevation is 10,635 feet and its spillway (10 feet wide at the north end) elevation is 10,634 feet. An 8 inch valve outlet (21.8 feet below spillway) is at elevation 10,613 feet. A second 6 inch outlet and gate valve is 9.1 feet below the spillway. Maximum capacity is 794 acre feet covering an area of 17 acres.

8. **Construction date:** 1905

Factual: XXXX

9. **Architect:** unknown

HISTORIC RESOURCES INVENTORY

Monarch Lake page 2 of 3

10. **Builder:** Mt. Whitney Power Company
11. **Approximate property size:** 1200' x 900'
12. **Dates of enclosed photographs:** July 22, 1933; 1985
13. **Condition:**

Good: XXXX

14. **Alterations:**

This dam, being subject to yearly inspections, is maintained on an "as needed" basis and using the same techniques and materials used for its original construction in 1905. Typically, as with other dams of this type at higher elevations, mortar on the upstream dam face requires the most maintenance. In 1963 the 6 inch outlet and gate valve was plugged with concrete.

15. **Surroundings:**

No buildings: XXXX

16. **Threats to site:**

None known: XXXX

17. **Is the structure:**

On its original site: XXXX

18. **Related features:** See attached index to features

SIGNIFICANCE

19. **Historical and/or architectural importance:**

The Monarch Lake Dam is one of the original remaining elements of the Kaweah No. 3 generation project. The dam has been little modified since construction in 1905 and has been maintained generally with in kind materials. The simple construction of the dam is functional although it is not distinctive either from an architectural or engineering perspective.

HISTORIC RESOURCES INVENTORY

Monarch Lake page 3 of 3

20. Main theme:

Economic/Industrial: XXXX

21. Sources:

BioSystems Analysis, Inc.

1989 Field notes. Personal communications with Dan Morgan

Southern California Edison

n.d. Kaweah No. 1 Miscellaneous File 5-A-1. On file in Requisitions and Reports, SCE Admin. Office, Kaweah Powerhouse No. 1.

1909 Stipulation for Judgement, Superior Court of the County of Tulare, State of California, File 700. On file in SCE Admin. Office, Kaweah Powerhouse No. 1.

1951 Mineral King Lakes Hydraulic Data, SCE File 700. Filed in Historical Files, SCE Admin. Office, Kaweah Powerhouse No. 1.

1963 1963 Dam Inspection, Plan, Elevation and Section of Monarch Lake Dam, SCE Drawing 110640-2, File 700. On file in Historical Files, SCE Admin. Office, Kaweah Powerhouse No. 1.

1975 Exhibit K, Kaweah Project No. 298, SCE Drawing 5150185. On file at SCE Admin. Office, Kaweah Powerhouse No. 1.

1975 Exhibit L, Kaweah No. 1 Mineral King Dams, Project 298, SCE Drawing 5148898. On file at SCE Admin. Office, Kaweah Powerhouse No. 1.

22. Date form prepared: August 15, 1989

**KAWEAH HYDROELECTRIC PROJECT
HISTORIC RESOURCES INVENTORY**



Monarch Lake Dam
SCE Historical Photo Album
View to NE
7-22-33



Monarch Lake Dam
Kaweah Powerhouse No. 1
View to SW
Courtesy, Dan Morgan, ca. 1985

HISTORIC RESOURCES INVENTORY

IDENTIFICATION

1. **Common name:** Crystal Lake
2. **Historic name:** Silver Lake
3. **Street or rural address:** Crystal Creek, a tributary of the East Fork of the Kaweah River
4. **Parcel number:** NA
5. **Present owner:** Southern California Edison Company
2204 Walnut Grove Avenue
Rosemead, CA 91770

Ownership is private: XXXX

6. **Present use:** Water storage reservoir
Original use: Same

DESCRIPTION

- 7a. **Architectural style:** Gravity dam, rubble/masonry type
- 7b. **Present physical appearance:**

Crystal Lake Dam is a buttressed dam 93 feet long and approximately 17 feet high. The dam is constructed of native rock mortared together 2 feet thick and capped with concrete along its crest. Loose rock rubble is placed between the buttresses on the downstream dam face. The dam spillway, at the north end, is 9.7 feet wide at an elevation of 10,786 feet. Maximum pool covers 12 acres and impounds 553 acre feet. There is an 8" outlet pipe and gate valve 16.8 feet below the spillway crest.

8. **Construction date:** 1903
Factual: XXXX
9. **Architect:** unknown
10. **Builder:** Mt. Whitney Power Co.

HISTORIC RESOURCES INVENTORY

Crystal Lake, page 2 of 3

11. **Approximate property size:** 1000' x 900'
12. **Dates of enclosed photographs:** July 22, 1933; August 4, 1943; 1985

13. **Condition:**

Good: XXXX

14. **Alterations:**

This dam, being subject to annual inspections has been maintained with the same techniques and materials as were used in its original construction. Maintenance has been undertaken on an "as needed" basis. In 1948 the outlet pipe was extended. As is typical with high elevation dams of this type most of the maintenance has been the removal and replacement of loose mortar between the rocks on its upstream face.

15. **Surroundings:**

No buildings: XXXX

16. **Threats to site:**

None known: XXXX

17. **Is the structure:**

On its original site: XXXX

18. **Related features:** See attached index to features

SIGNIFICANCE

19. **Historical and/or architectural importance:**

The Crystal Lake Dam is one of the original remaining elements of the Kaweah No. 3 generation project. The dam has been little modified since construction in 1903 and has been maintained generally with in kind materials. The simple construction of the dam is functional although it is not distinctive either from an architectural or engineering perspective

HISTORIC RESOURCES INVENTORY

Crystal Lake, page 3 of 3

20. Main theme:

Economic/Industrial: XXXX

21. Sources:

BioSystems Analysis, Inc.

1989 Field notes. Personal communications with Dan Morgan

Southern California Edison

n.d. Kaweah No. 1 Miscellaneous File 5-A-1. On file in Requisitions and Reports, SCE Admin. Office, Kaweah Powerhouse No. 1.

1909 Stipulation for Judgement, Superior Court of the County of Tulare, State of California, File 700. On file in SCE Admin. Office, Kaweah Powerhouse No. 1.

1963 1963 Dam Inspection, Plan Profile and Section of Crystal Lake Dam, SCE Drawing 113689-2, File 700. On file in Historical Files, SCE Admin. Office, Kaweah Powerhouse No. 1.

1975 Exhibit K, Kaweah Project No. 298, SCE Drawing 5150185. On file at SCE Admin. Office, Kaweah Powerhouse No. 1.

1975 Exhibit L, Kaweah No. 1 Mineral King Dams, Project 298, SCE Drawing 5148898. On file at SCE Admin. Office, Kaweah Powerhouse No. 1.

22. Date form prepared: August 15, 1989

**KAWEAH HYDROELECTRIC PROJECT
HISTORIC RESOURCES INVENTORY**



Crystal Lake Dam
SCE Historical Photo Album
View to SW
8-4-43



Crystal Lake Dam
SCE Historical Photo Album
View to SW
7-22-33



Crystal Lake Dam
Kaweah Powerhouse No. 1
View to S
Courtesy, Dan Morgan, ca. 1985

**KAWEAH HYDROELECTRIC PROJECT
HISTORIC RESOURCES INVENTORY**



Crystal Lake Dam
Kaweah Powerhouse No. 1
View to S
Courtesy, Dan Morgan, ca. 1985

APPENDIX E

**Project Area Maps
Kaweah No. 3**

SEQUOIA

NATIONAL

PARK

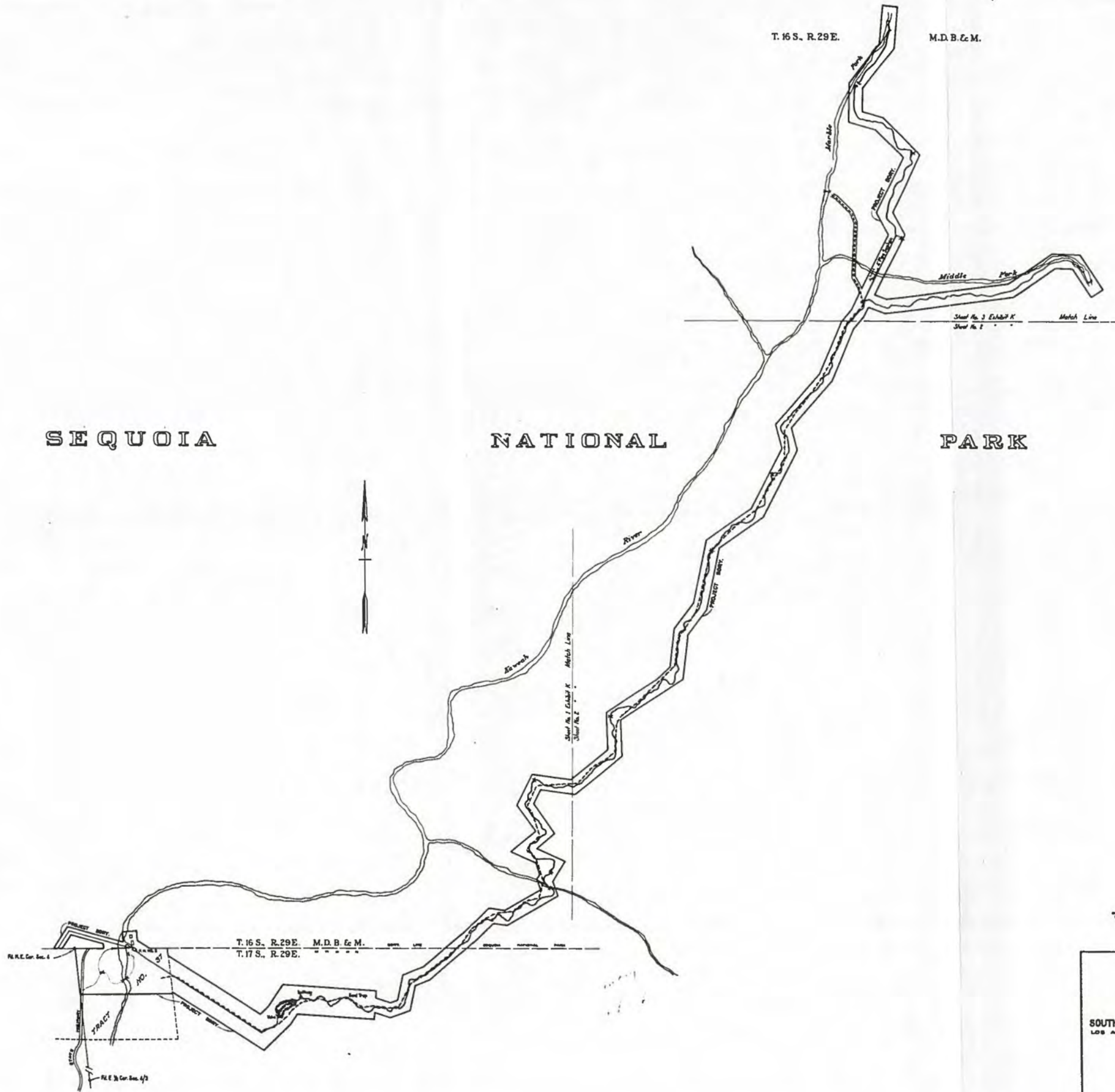

APPENDIX E, MAP 1

SCE Exhibit J, Kaweah No. 3
Map No. 521298

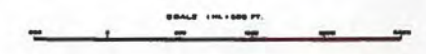

EXHIBIT - J
KEY MAP
OF
KAWEAH NO. 3 PROJECT

SOUTHERN CALIFORNIA EDISON COMPANY LTD.
LOS ANGELES CALIFORNIA

SEQUOIA

NATIONAL

PARK

APPENDIX E, MAP 2

SCE Exhibit K, Kaweah No. 3
Map No. 521299

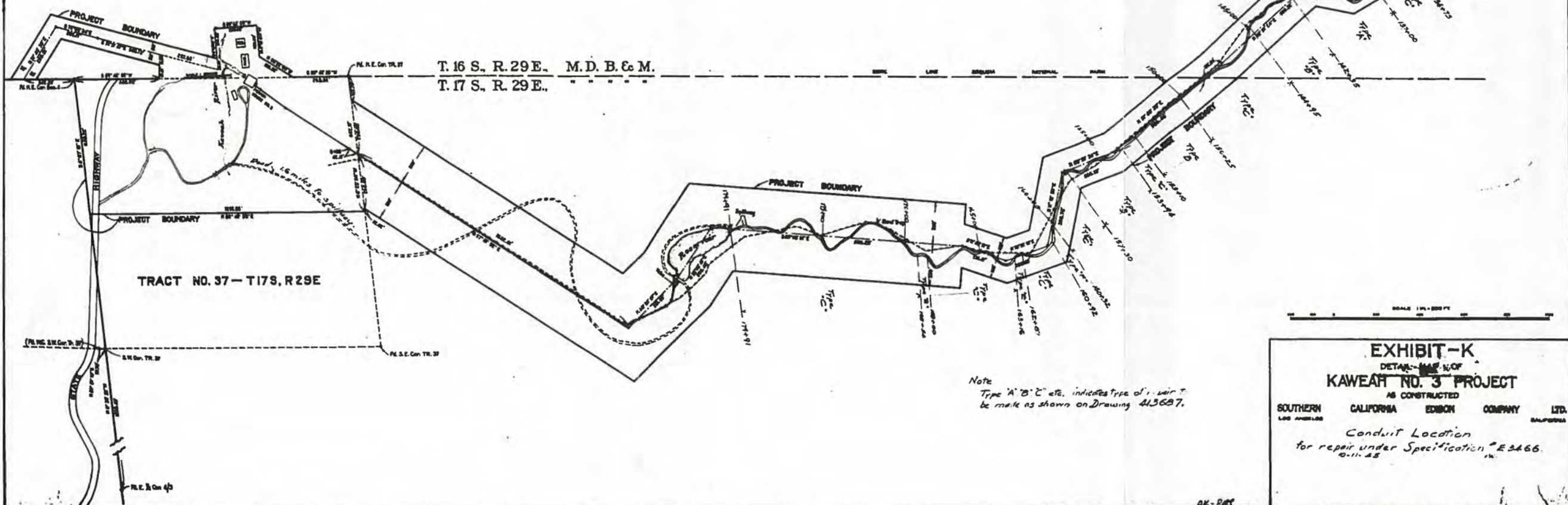

Note
Type 'A' 'B' 'C' etc. indicates type of wire to
be made as shown on Drawing 413687.

EXHIBIT-K
DETAIL - MAP NO. 3 OF
KAWEAH NO. 3 PROJECT
AS CONSTRUCTED
SOUTHERN CALIFORNIA EDISON COMPANY LTD.
LOS ANGELES CALIFORNIA
Conduit Location
for repair under Specification E 3466
11-1-28

521299

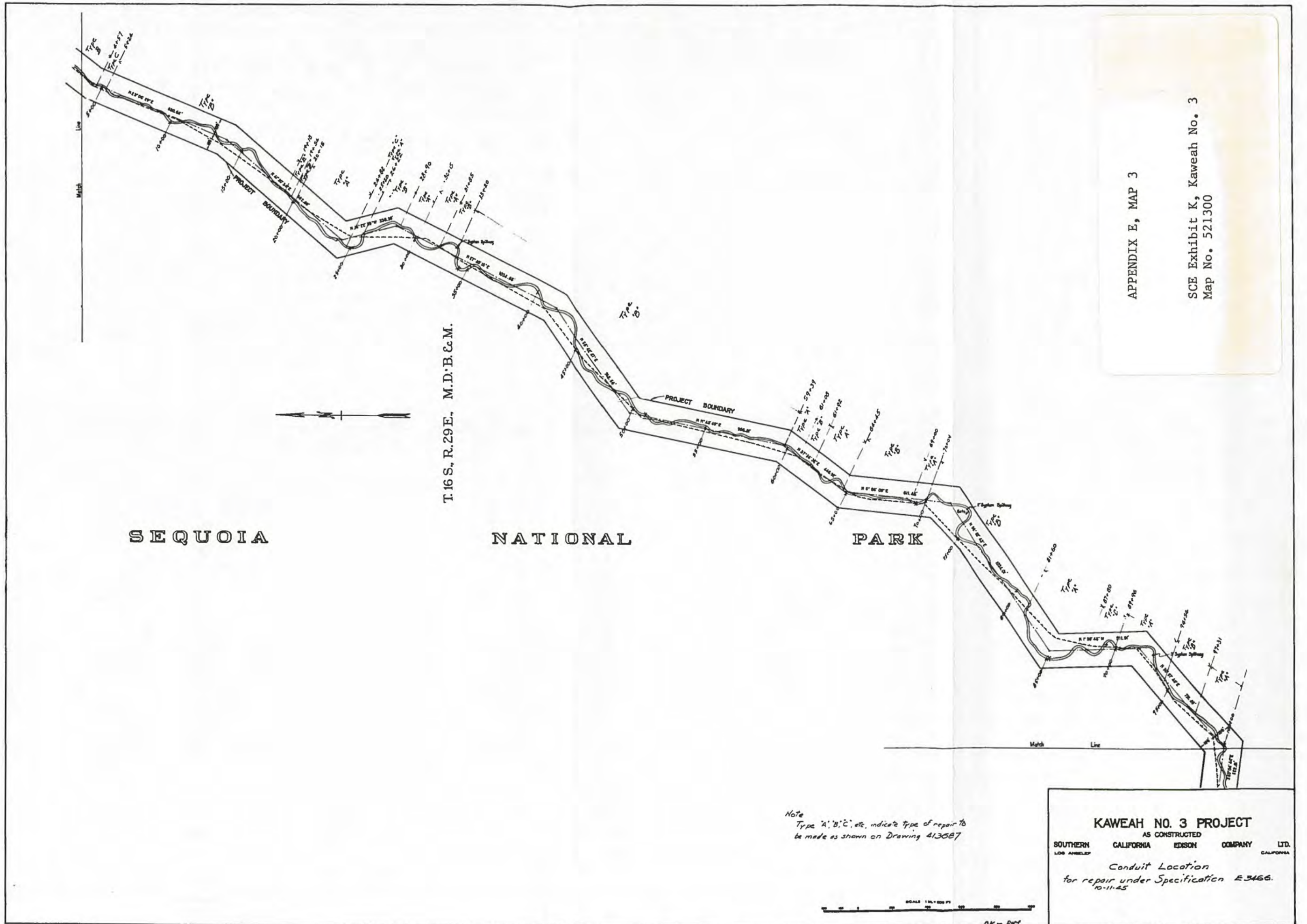

APPENDIX E, MAP 3

SCE Exhibit K, Kaweah No. 3
Map No. 521300

SEQUOIA

NATIONAL

PARK

T. 16 S., R. 29 E., M. D. B. & M.

Note
Type "A", "B", "C", etc. indicate type of repair to
be made as shown on Drawing 413087

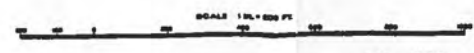

OK-PR1

KAWEAH NO. 3 PROJECT
AS CONSTRUCTED
SOUTHERN CALIFORNIA EDISON COMPANY LTD.
LOS ANGELES CALIFORNIA
Conduit Location
for repair under Specification E-3466.
10-11-45

521300

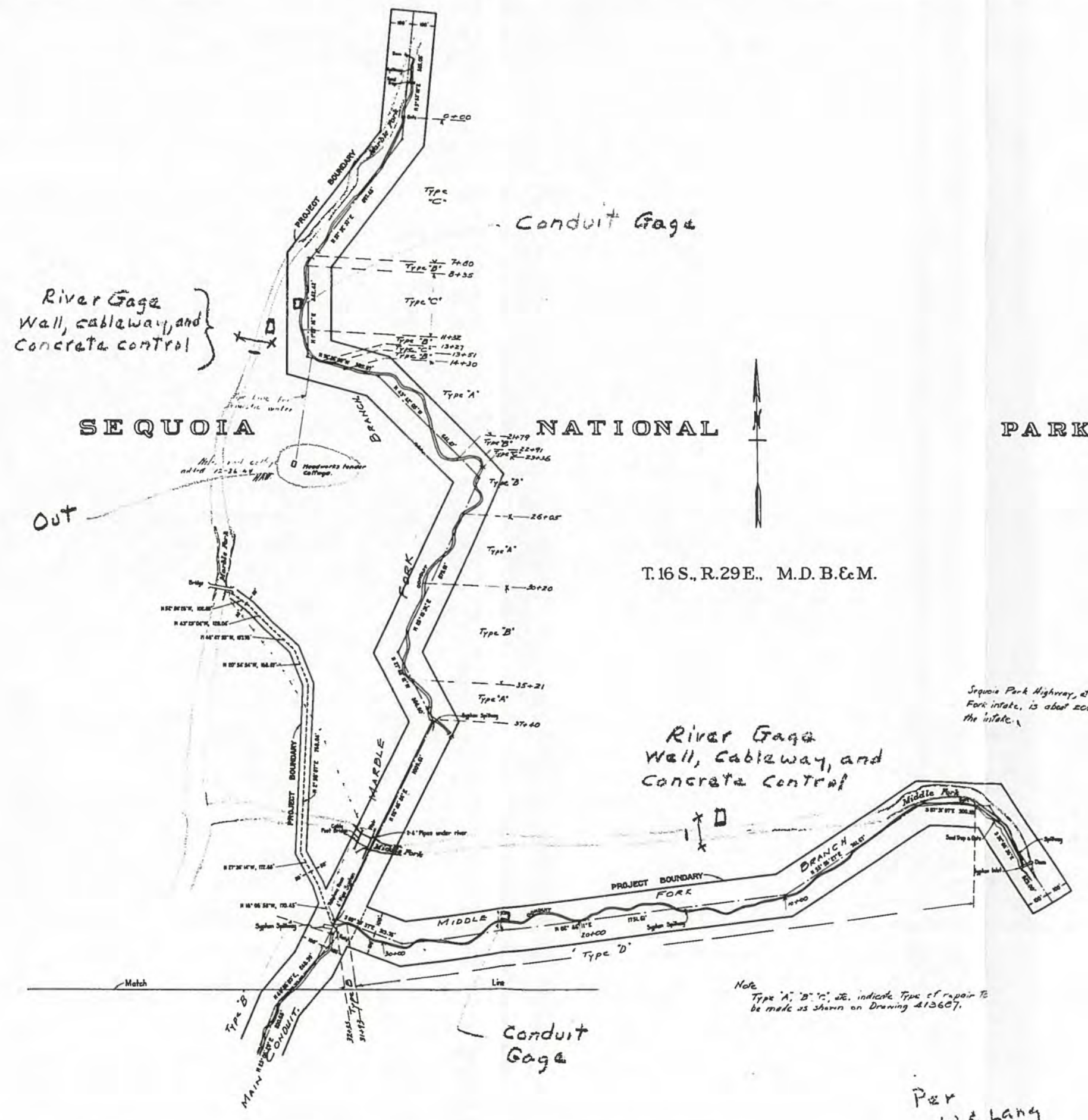

River Gage
Wall, cableway, and
concrete control

Conduit Gage

SEQUOIA NATIONAL PARK

T. 16 S., R. 29 E., M. D. B. & M.

River Gage
Wall, cableway, and
concrete control

Sequoia Park Highway, at a point opposite the Middle
Fork intake, is about 200 ft higher elevation than
the intake.

Conduit
Gage

Note
Type 'A', 'B', 'C', etc. indicate type of repair to
be made as shown on Drawing #13607.

Per
W. J. Lang

APPENDIX E, MAP 4

SCE Exhibit K, Kaweah No. 3
Map No. 521301

SCALE 1" = 200' FE

KAWEAH NO. 3 PROJECT
AS CONSTRUCTED
SOUTHERN CALIFORNIA EDISON COMPANY LTD.
LOS ANGELES CALIFORNIA

Conduit Location
for repair under Specification #E3465
10-11-25

APPENDIX D

Archival Drawings and Plans

Additional drawings and plans of Kaweah Project Facilities are included in Exhibit F of the License Application. They are being withheld from public disclosure in accordance with applicable regulations as they contain specific engineering and design information that relates to the generation and transmission of electric energy and qualifies as Critical Energy/Electric Infrastructure Information (CEII) under 18 CFR §388.113. To further understand FERC's regulations regarding CEII filings visit: <https://www.ferc.gov/legal/ceii-foia/ceii.asp>.

This Page Intentionally Left Blank

Kaweah No. 1 Powerhouse and Penstock

Note: Additional Drawings Included in Exhibit F

Kaweah No. 1 Diversion Dam

Note: Drawings Included in Exhibit F

Kaweah No. 1 Flowline

517397 D264

MT. WHITNEY POWER AND ELECTRIC CO. MAP OF

CONDUIT LINE AND PRESSURE PIPE LINE LOCATED IN THE SEQUOIA NATIONAL FOREST

Drawn by A.B.S., L.H.G. and N.C.W.
February 1911
Scale, 1 inch = 1000 feet

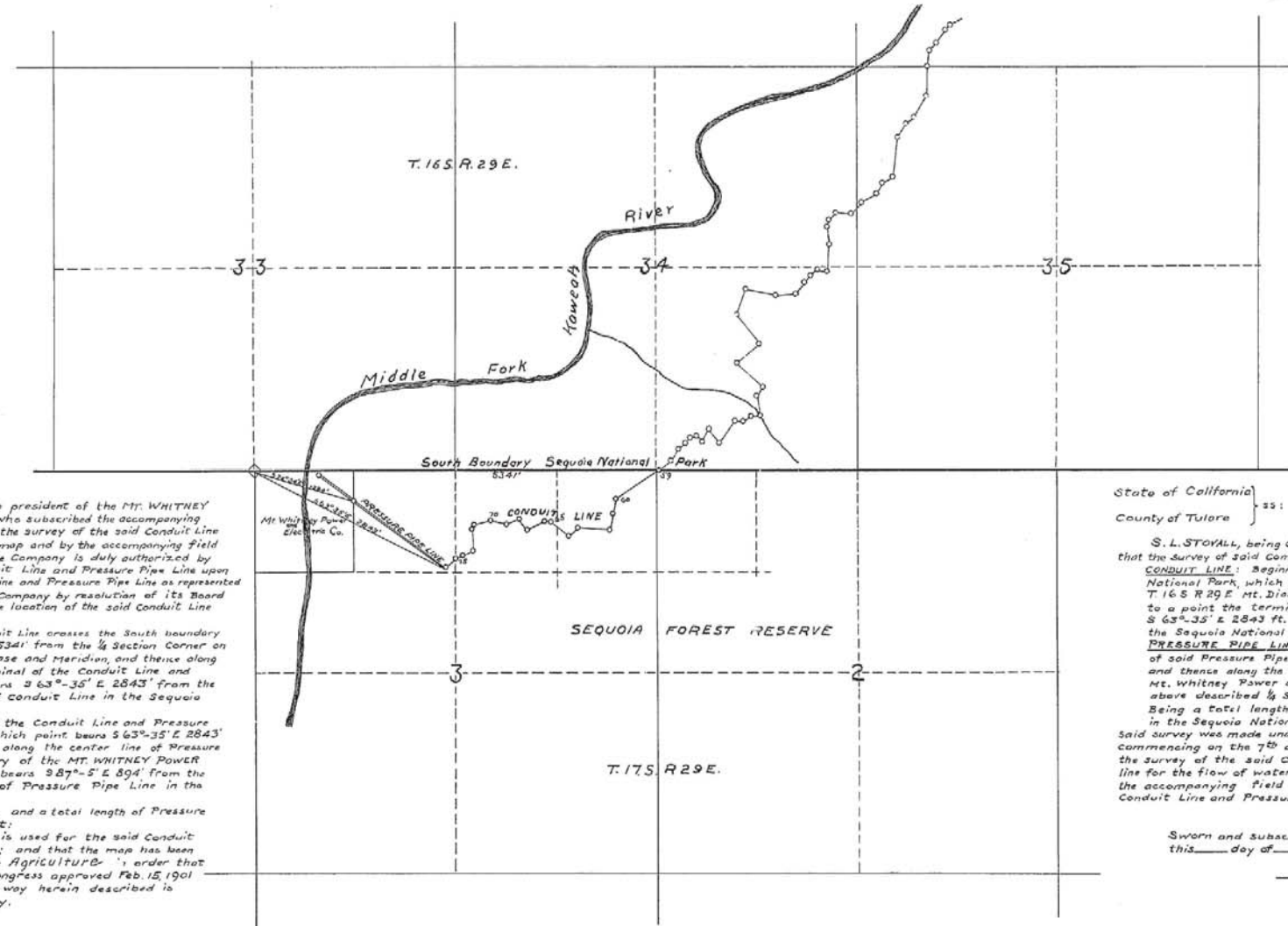

I, JOHN COFFEE HAYS, do hereby certify that I am president of the MT. WHITNEY POWER AND ELECTRIC COMPANY; that S. L. STOVALL, who subscribed the accompanying affidavit is the Chief Engineer of the said Company; that the survey of the said Conduit Line and Pressure Pipe Line as accurately represented on this map and by the accompanying field notes was made under authority of the Company; that the Company is duly authorized by its articles of incorporation to construct the said Conduit Line and Pressure Pipe Line upon the location shown upon this map; that the said Conduit Line and Pressure Pipe Line as represented on this map and by said field notes was adopted by the Company by resolution of its Board of Directors on the _____ day of _____ 1911, as the definite location of the said Conduit Line and Pressure Pipe Line, described as follows:

CONDUIT LINE: Beginning at a point where the Conduit Line crosses the South boundary line of the Sequoia National Park, which point bears East 5341' from the 1/4 Section Corner on the South line of Section 33, T. 16 S. R. 29 E. Mt. Diablo Base and Meridian, and thence along the center line of said Conduit Line to a point the terminal of the Conduit Line and junction with the Pressure Pipe Line, which point bears S 63°-35' E 2843' from the above described 1/4 Section Corner. Total length of Conduit Line in the Sequoia National Forest .735 mile.

PRESSURE PIPE LINE: Beginning at the junction of the Conduit Line and Pressure Pipe Line, the initial point of said Pressure Pipe Line, which point bears S 63°-35' E 2843' from the above described 1/4 Section Corner, and thence along the center line of Pressure Pipe Line to a point where it crosses the East boundary of the MT. WHITNEY POWER AND ELECTRIC COMPANY'S patented land, which point bears S 87°-5' E 894' from the above described 1/4 Section Corner. Total length of Pressure Pipe Line in the Sequoia National Forest, 1505 ft.

Being a total length of Conduit Line of .735 mile, and a total length of Pressure Pipe Line of .285 mile in the Sequoia National Forest; and that no lake or lake bed, stream or stream bed is used for the said Conduit Line and Pressure Pipe Line except as shown on this map; and that the map has been prepared to be filed for the approval of the Secretary AGRICULTURE; in order that the Company may obtain the benefits of the act of Congress approved Feb. 15, 1901 (31 Stat. 792) and I further certify that the right-of-way herein described is desired for the purpose of generating electrical energy.

ATTEST: _____
Secretary

President of the MT. WHITNEY POWER AND ELECTRIC COMPANY

State of California } 35:
County of Tulare }

S. L. STOVALL, being duly sworn, says he is the Chief Engineer of the MT. WHITNEY POWER AND ELECTRIC COMPANY, that the survey of said Company's Conduit Line and Pressure Pipe Line, described as follows:

CONDUIT LINE: Beginning at a point where the Conduit Line crosses the South boundary line of the Sequoia National Park, which point bears East 5341' from the 1/4 Section Corner on the South line of Section 33, T. 16 S. R. 29 E. Mt. Diablo Base and Meridian, and thence along the center line of said Conduit Line to a point the terminal of the Conduit Line and junction with the Pressure Pipe Line, which point bears S 63°-35' E 2843' from the above described 1/4 Section Corner. Total length of Conduit Line in the Sequoia National Forest .735 mile.

PRESSURE PIPE LINE: Beginning at the junction of the Conduit Line and Pressure Pipe Line, the initial point of said Pressure Pipe Line, which point bears S 63°-35' E 2843' from the above described 1/4 Section Corner and thence along the center line of Pressure Pipe Line to a point where it crosses the East boundary of the Mt. Whitney Power and Electric Company's patented land, which point bears S 87°-5' E 894' from the above described 1/4 Section Corner. Total length of Pressure Pipe Line in the Sequoia National Forest, 1505 ft. Being a total length of Conduit Line of .735 mile and a total length of Pressure Pipe Line of .285 mile in the Sequoia National Forest;

Said survey was made under his direction as Chief Engineer of the Company and under its authority, commencing on the 7th day of January 1911 and ending on the 12th day of January 1911, and that the survey of the said Conduit Line and Pressure Pipe Line accurately represents a proper grade line for the flow of water, and that such survey is accurately represented upon this map and by the accompanying field notes, and no lake or lake bed, stream or stream bed is used for the said Conduit Line and Pressure Pipe Line except as shown on this map.

Sworn and subscribed to before me
this _____ day of _____ 1911.

Chief Engineer

Notary Public

517397 D264

KAMICAN

Kaweah No. 1 Forebay

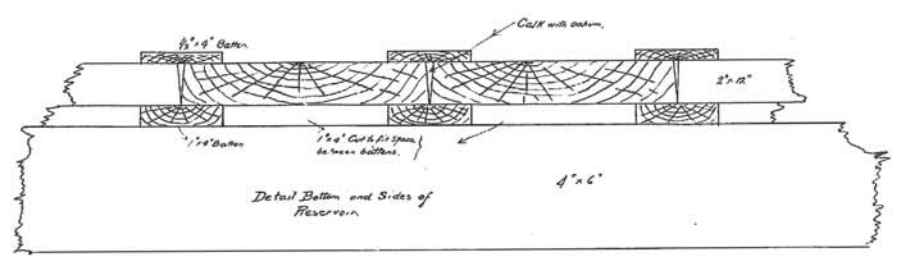
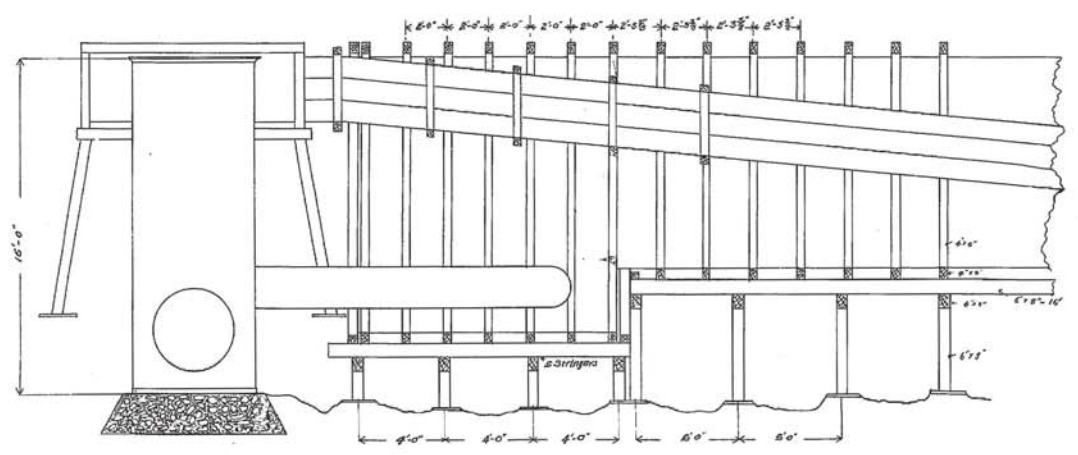
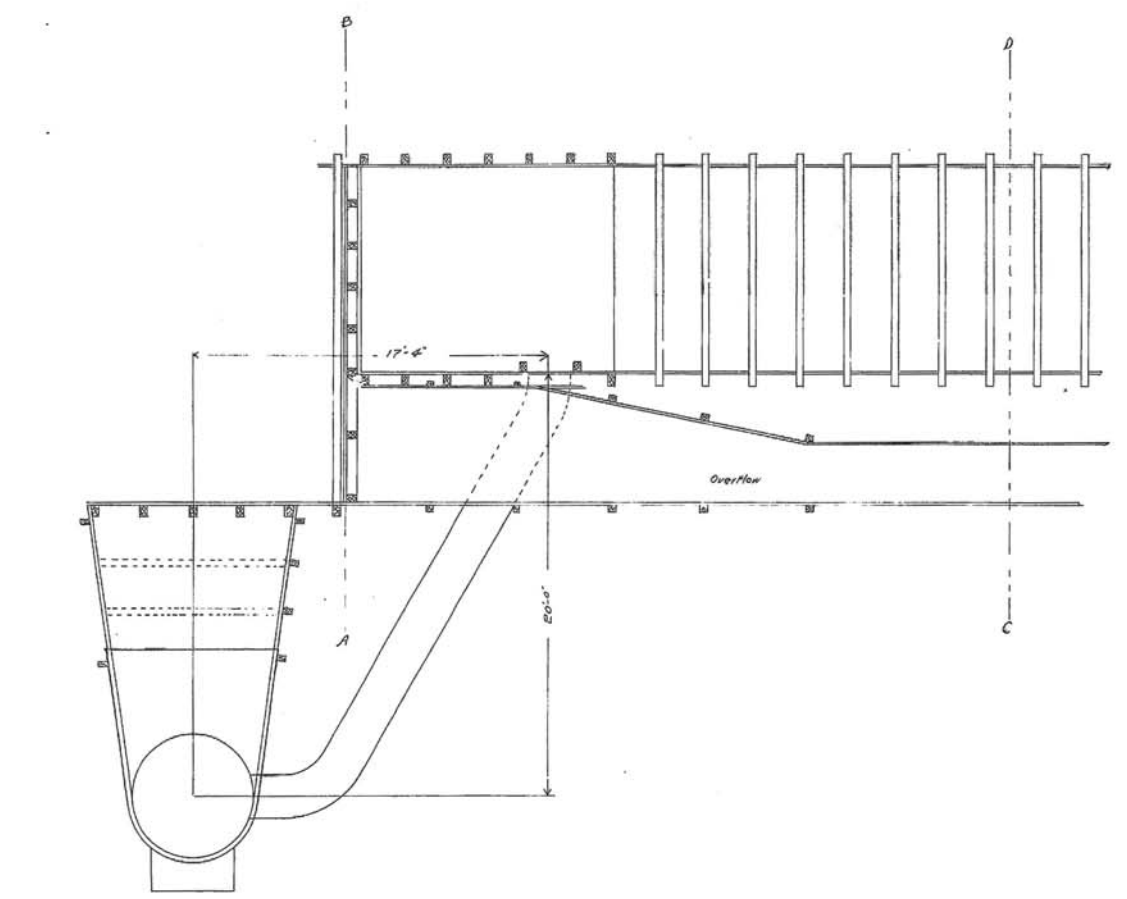

Regulating Reservoir for Penstock
 PLANT NO. 1
 Utility Power Co.
 Visalia, Calif.
 Date: 4-23-06
 Drawn by:

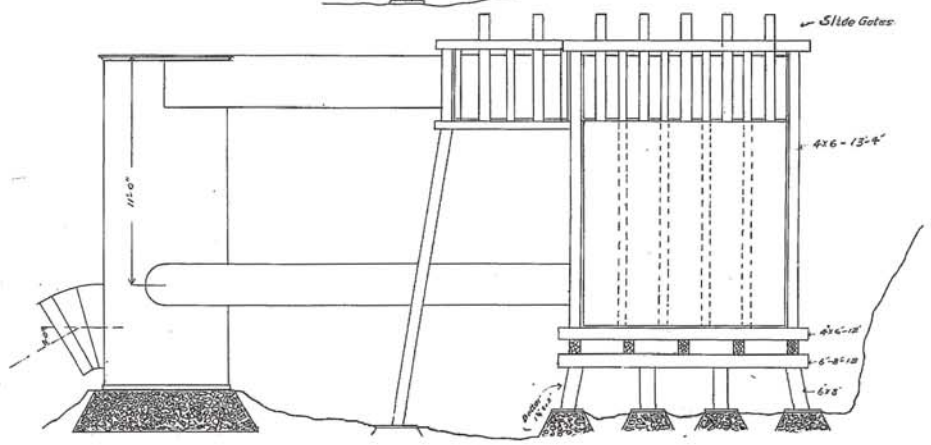
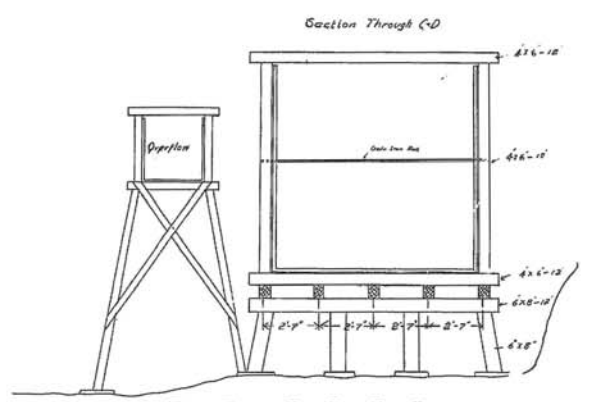

Kaweah No. 1 Powerhouse Campus

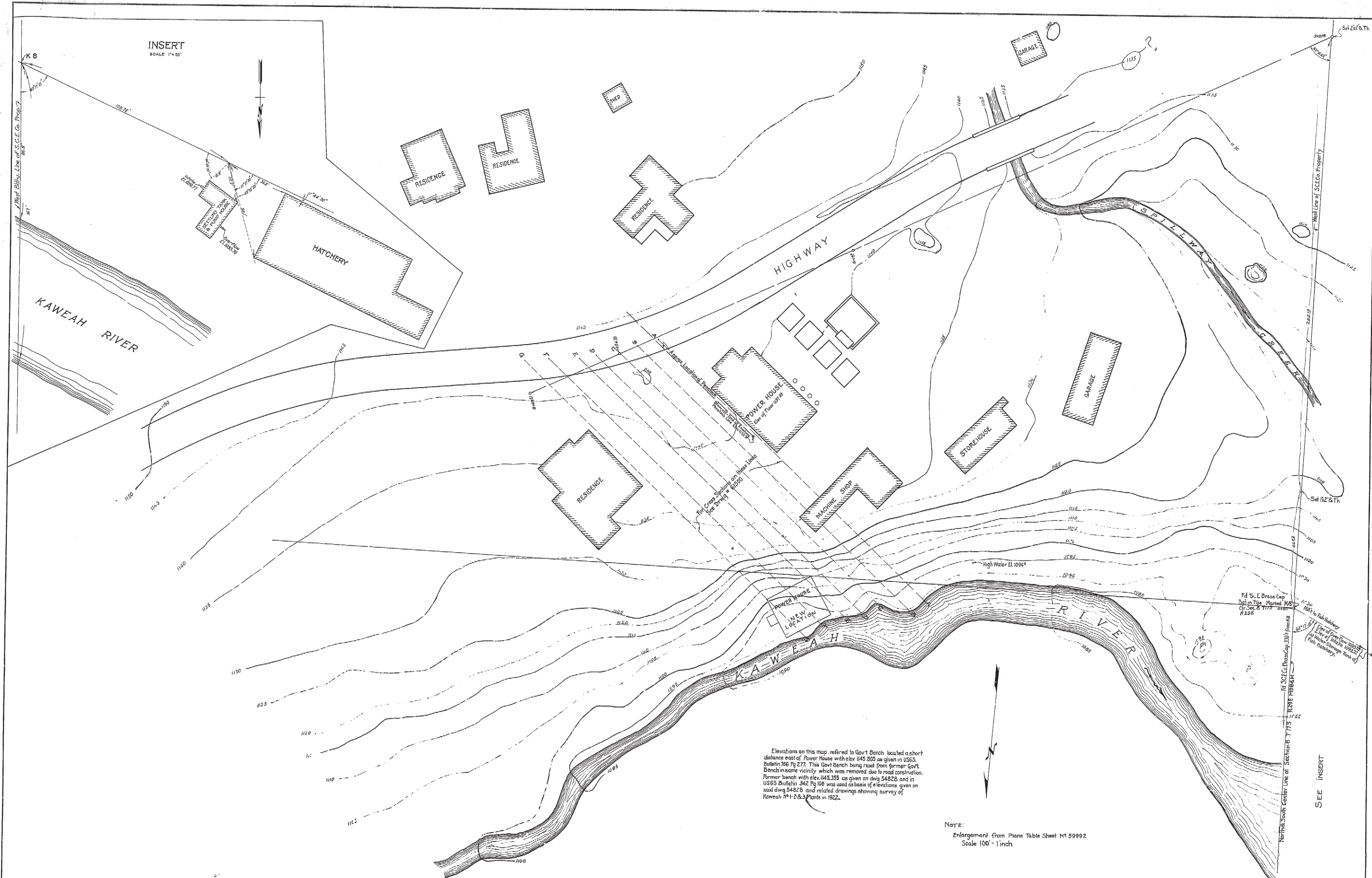

Elevations on this map referred to Govt Bench located a short distance east of Power House with elev. 1145.805 as given in USGS Bulletin 766 Pg 277. This Govt bench being used from former Govt Bench in same vicinity which was removed due to road construction. Former bench with elev. 1145.359 as given on dwg 54828 and in USGS Bulletin 342 Pg 106 was used as basis of elevations given on said dwg 54828 and related drawings showing survey of Kaweah No. 1-2 & 3 plants in 1922.

NOTE:
Enlargement from Plane Table Sheet No 59992
Scale 100' = 1" inch

MAP SIZE 130-74

REVISIONS	DATE	REVISIONS	DATE	CROSS REFERENCES	CALCULATIONS	FIELD BOOK	PAGES	SURVEY BY	APPROVED
		Fish hatchery added.	3-15-29	Plane Table Sheet # 59992 Dwg 61300 519994 Location new RH.	MAP SIZE PAGE SERIAL NUMBERS	4455	8-22 18419	Wilson Fuller Fuller Fuller Guld	APPROVED <i>James H. Fuller</i>
								SCALE 1" = 20'	GENERAL
								DATE 8-3-28	J.D. 636

SOUTHERN CALIFORNIA EDISON CO.
ENGINEERING DEPARTMENT LOS ANGELES, CALIFORNIA
LOCATION KAWEAH No 1
EXISTING BUILDINGS AND TOPOGRAPHY IN VICINITY OF PROPOSED NEW KAWEAH No 1 POWER HOUSE AND PENSTOCK EXTENSION

Mineral King Dams

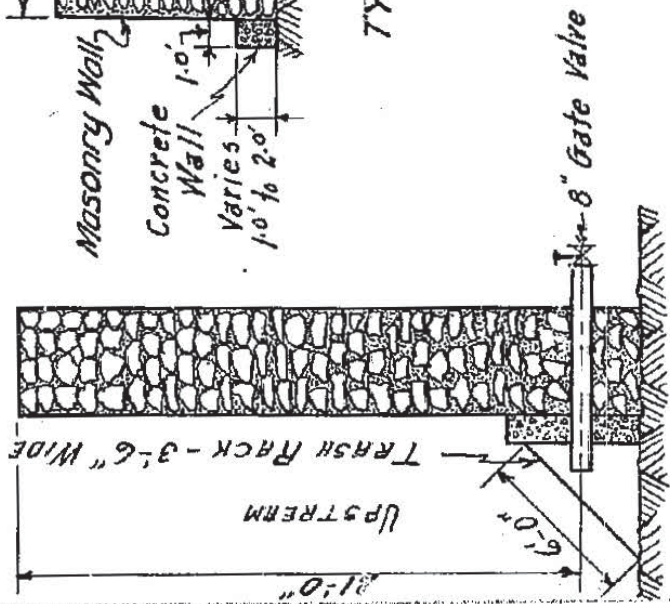
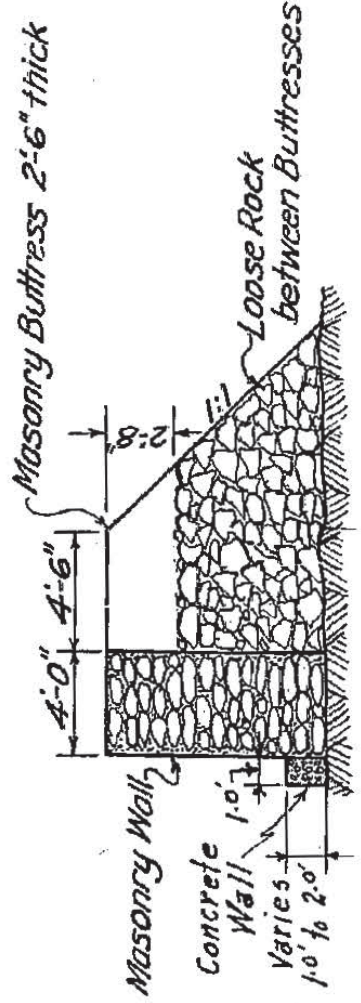
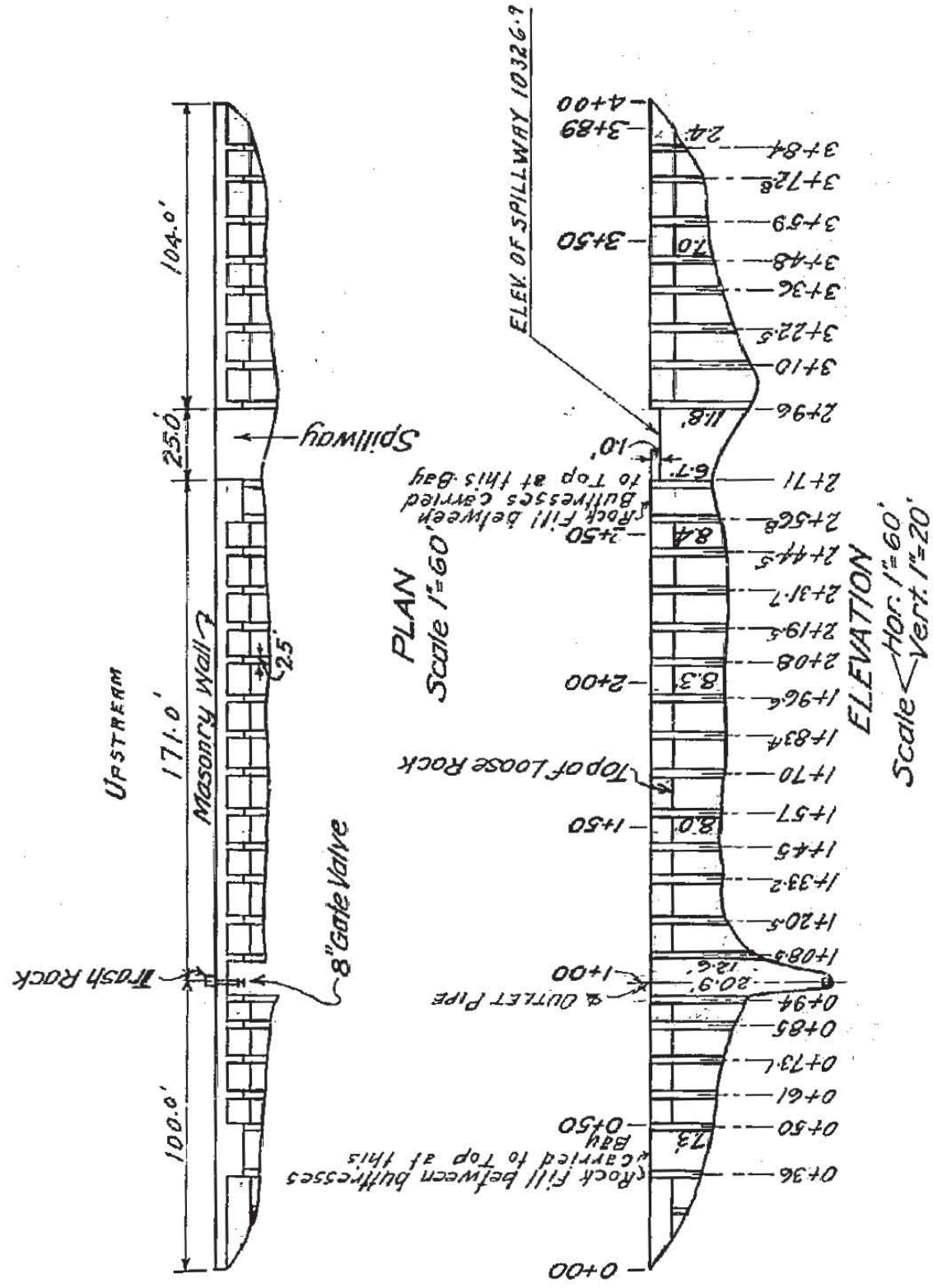

1500 c.y.
 Drainage Area: 1.3 Sq. miles
 Area of Reservoir: 30.4 Acres
 Capacity of Reservoir: 467.2 Ac. Ft.
 Discharge for valve wide open - water surface at Spillway level: 9.4 C.F.S.

Completed - Sept., 1905.

KAWAHEAN RIVER	
C.L.R.	VARIOUS
C.L.R.	9-23-30
W.G.P.	
PLAN, ELEVATION & SECTION OF FRANKLIN LAKE DAM	

9-25-30 A.W.D.

Changes and additions J.E.M. from notes made by Mr. Morrison of State Dept. of Public Works 10-25-32
 Div. of Water Resources

110346-1

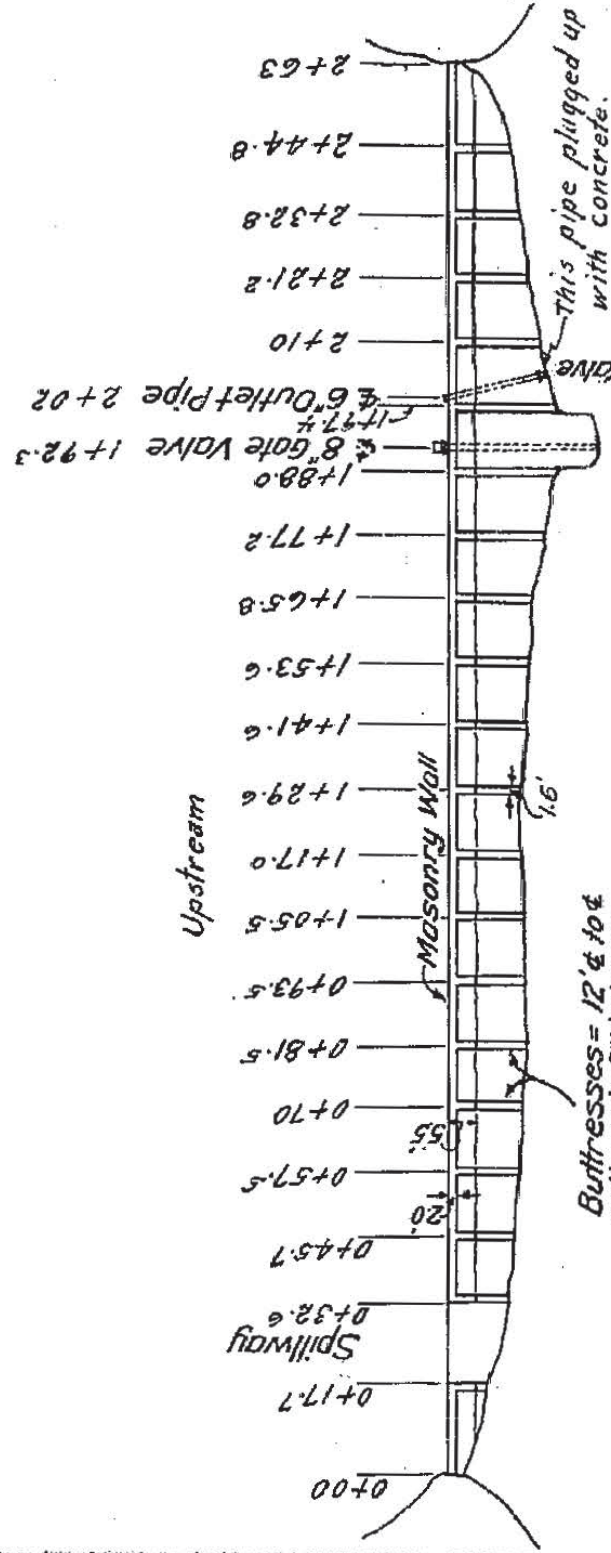

PLAN

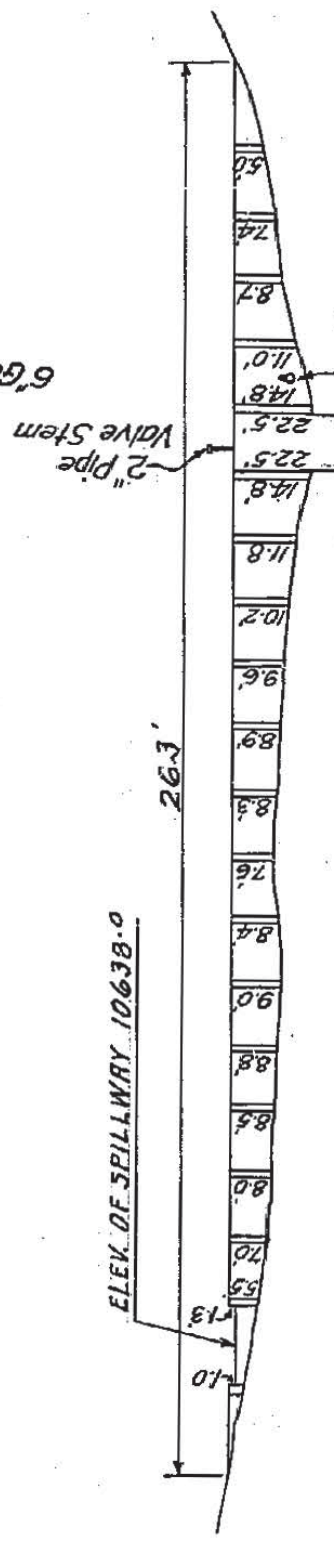

ELEVATION
Scale 1"=40'

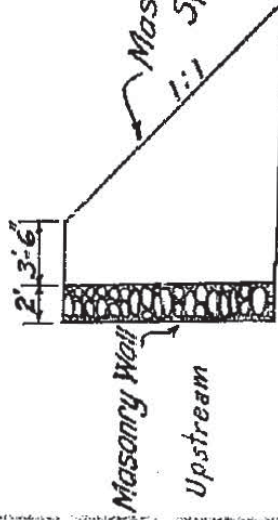

TYPICAL CROSS-SECTION

Scale 1"=12'

Discharge for 8" Pipe - valve wide open - water surface at Spillway level 9.0 C.F.S.

Capacity of Reservoir 314 Ac. Ft., Area of Reservoir 17.1 Acres, Drainage Area 0.3 Sq. miles
Completed Sept., 1905

FB. 3925
KAWEAH RIVER
PLAN, ELEVATION & SECTION
OF MONARCH LAKE DAM

9/30/35	PLUG IN 6" PIPE NOTED	9-2530	W.C.M.	C.L.R.	1"=12'	1"=40'
12/19/04	Changes and			C.L.R.	9-16-30	
	J.E.W. Additions *			W.G.P.		

* From notes made by Mr. Morrison of State Dept. of Public Works - Div. of Water Resources - 10-26-32.

110640-2

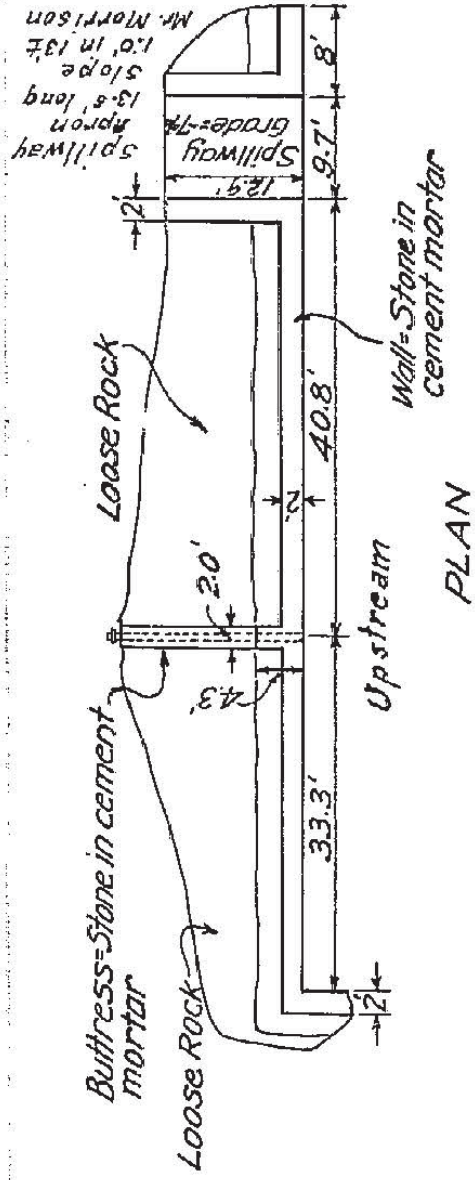

PLAN

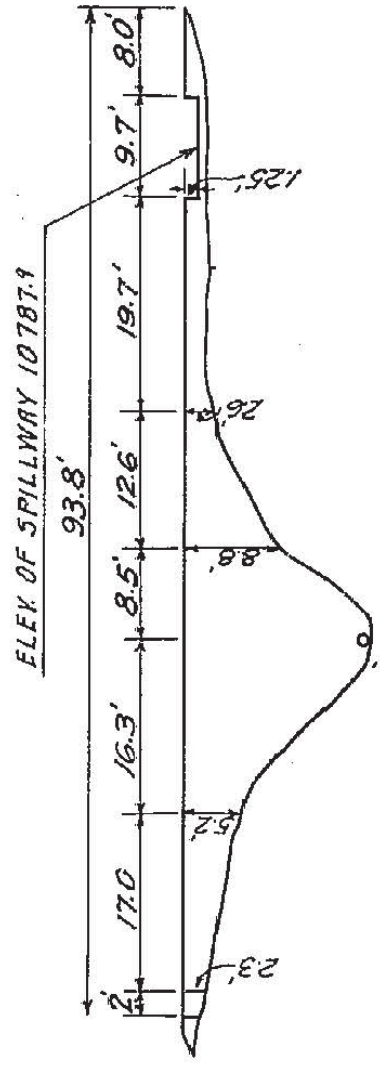

PROFILE AT UPSTREAM FACE
Scale 1"=20'

Area of Reservoir 12.5 Acres
Drainage Area 0.25 Sq. miles

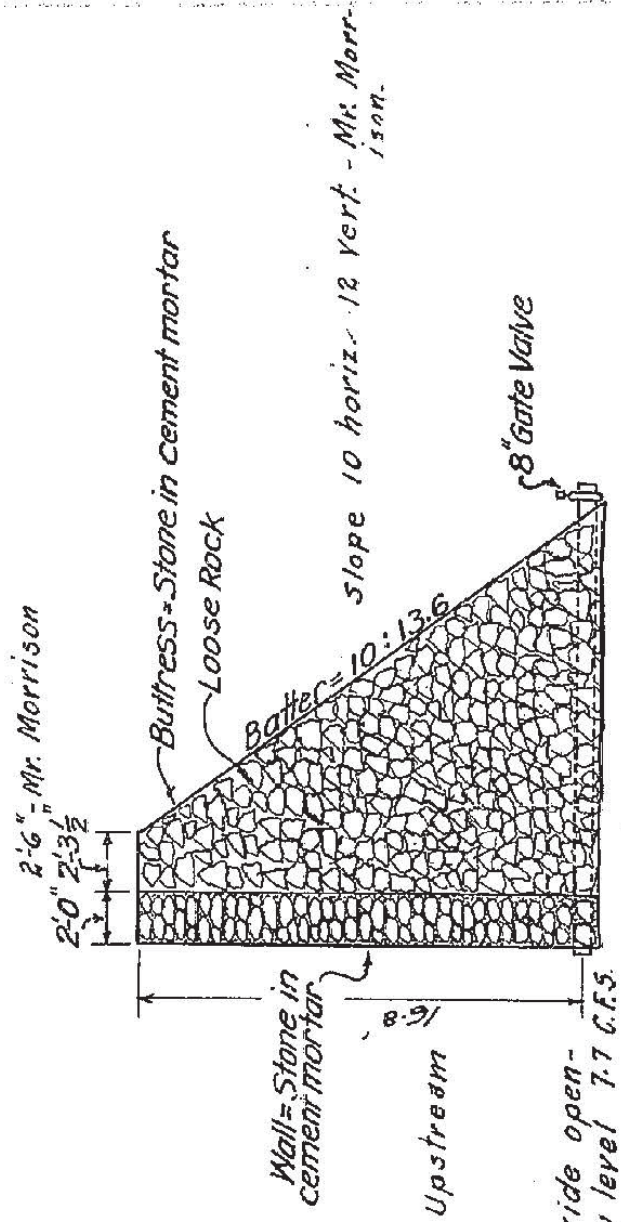

SECTION NEAR BUTTRESS FOR OUTLET PIPE
Scale 1"=8'

F.B. 3925

Completed 1903. * NOTE: CALLED SILVER LAKE IN OUR RECORDS AND SURVEY DATA

KAWEAH RIVER
PLAN PROFILE AND SECTION
OF CRYSTAL LAKE DAM

9-25-30 A.C.W.D.
7/23/35 CHANGED NAME FROM SILVER LAKE TO CRYSTAL LAKE (U.S.G.S NAME)

C.L.R. 1"=8'
C.L.R. 1"=20'
W.G.P. 9-18-30

notes made by Mr. Morrison of State Dept. of Public Works -
Div of Water Resources 10-26-32

113689 - 2

Kaweah No. 2 Powerhouse

25

517252

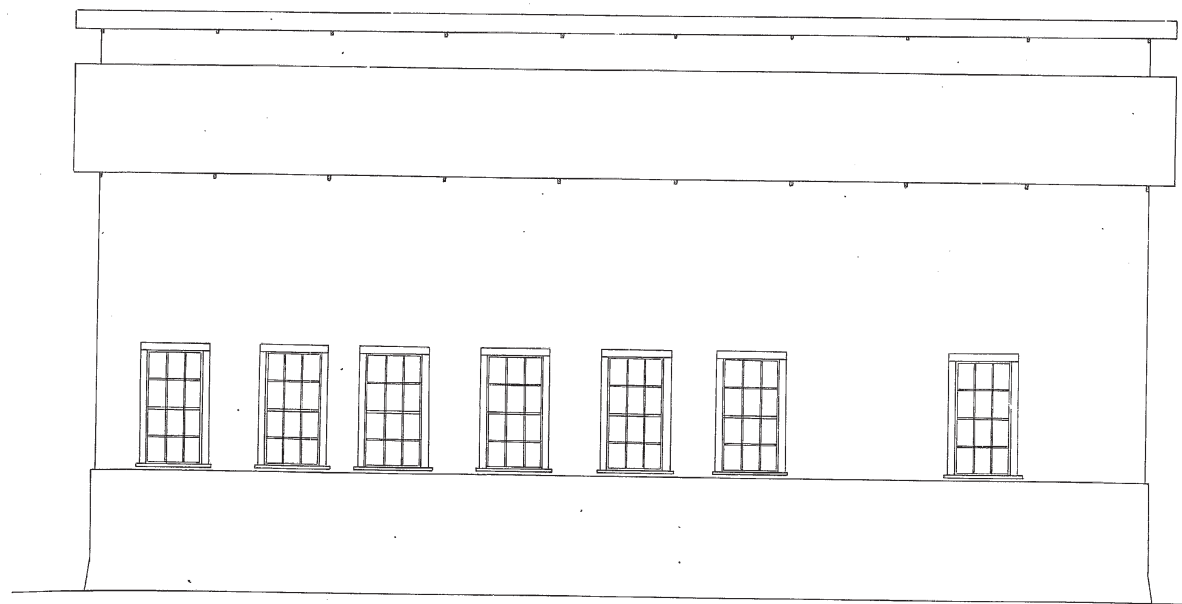
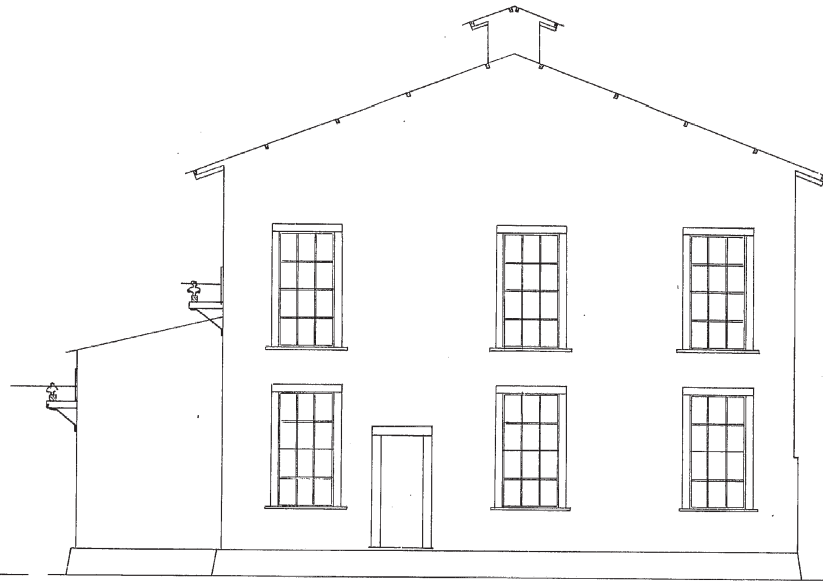
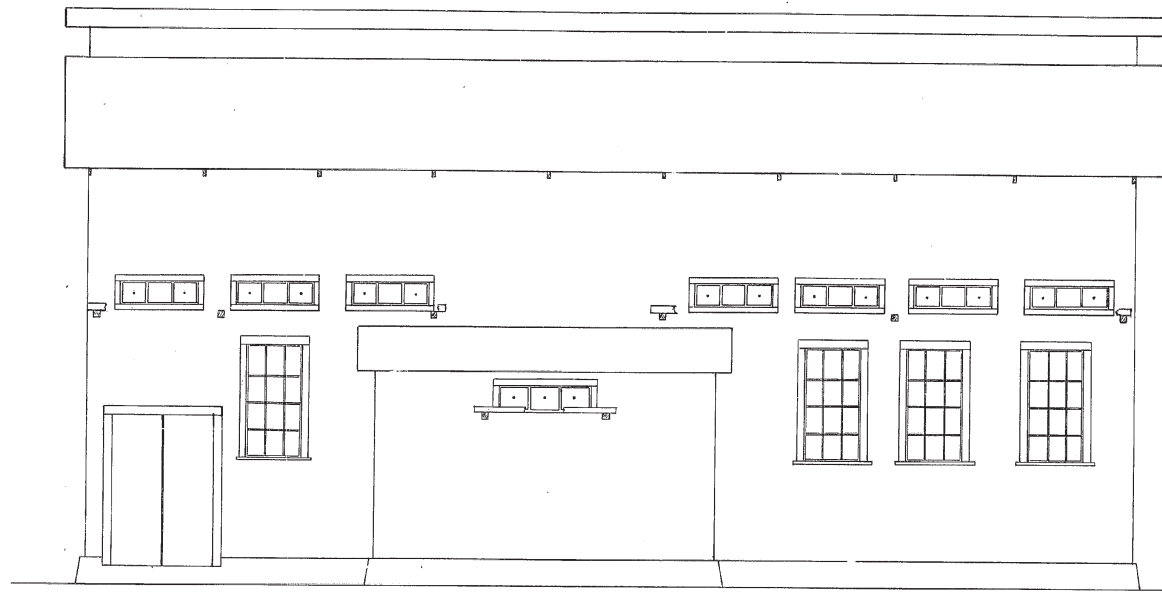

POWER HOUSE No. 2

517252

Scale 3/8"=1'

4/27/04

Drawn by H.H.H.

INVENTORY 1059

31-29

RAWLINS #2

2'x

Kaweah No. 2 Diversion Dam

Note: Additional Drawings Included in Exhibit F

517249

KPOWER #2
3-29

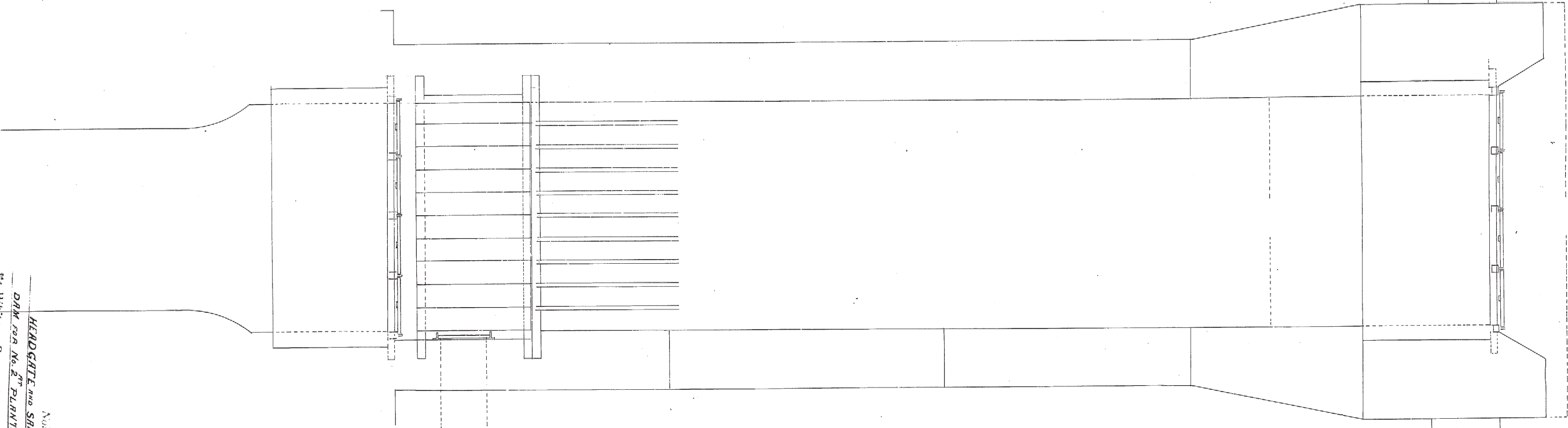
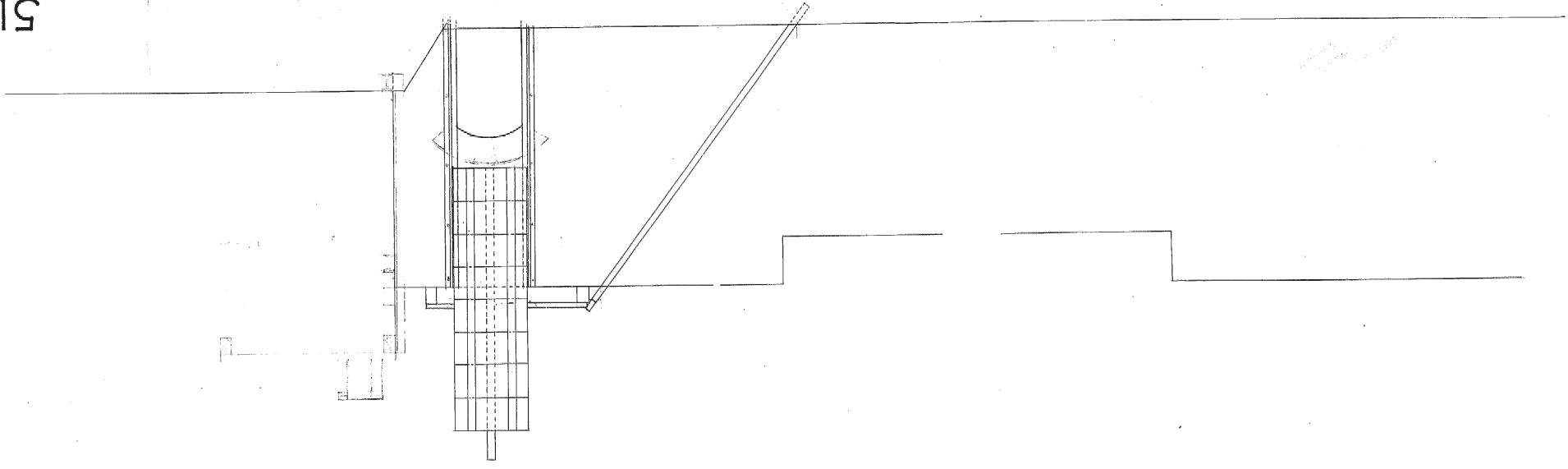

N. H. S.
 HEADGATE and SAND BARR.
 DAM FOR No. 2 PLANT. 11-1-50
 Mt. Whitney Power Co.
 Visalia, Calif.
 Date

517249



MICROFILMED FROM

Kaweah No. 2 Flowline

Note: Additional Drawings Included in Exhibit F

~~776~~

Mt Whitney Power Company
By *[Signature]* Manager

517248
copy from original

Mt. WHITNEY POWER CO.

[Signature]

DETAIL OF FLUME

No. 2 PLANT.

Scale 1/2 inches = one foot
Jan 8th 1904 L.E. McCabe C.E.

Detail Section of Flume
Scale 1/2" to foot

Copy from the original drawing Dec. 6, 1904.
MMH

Detail Side View of Flume

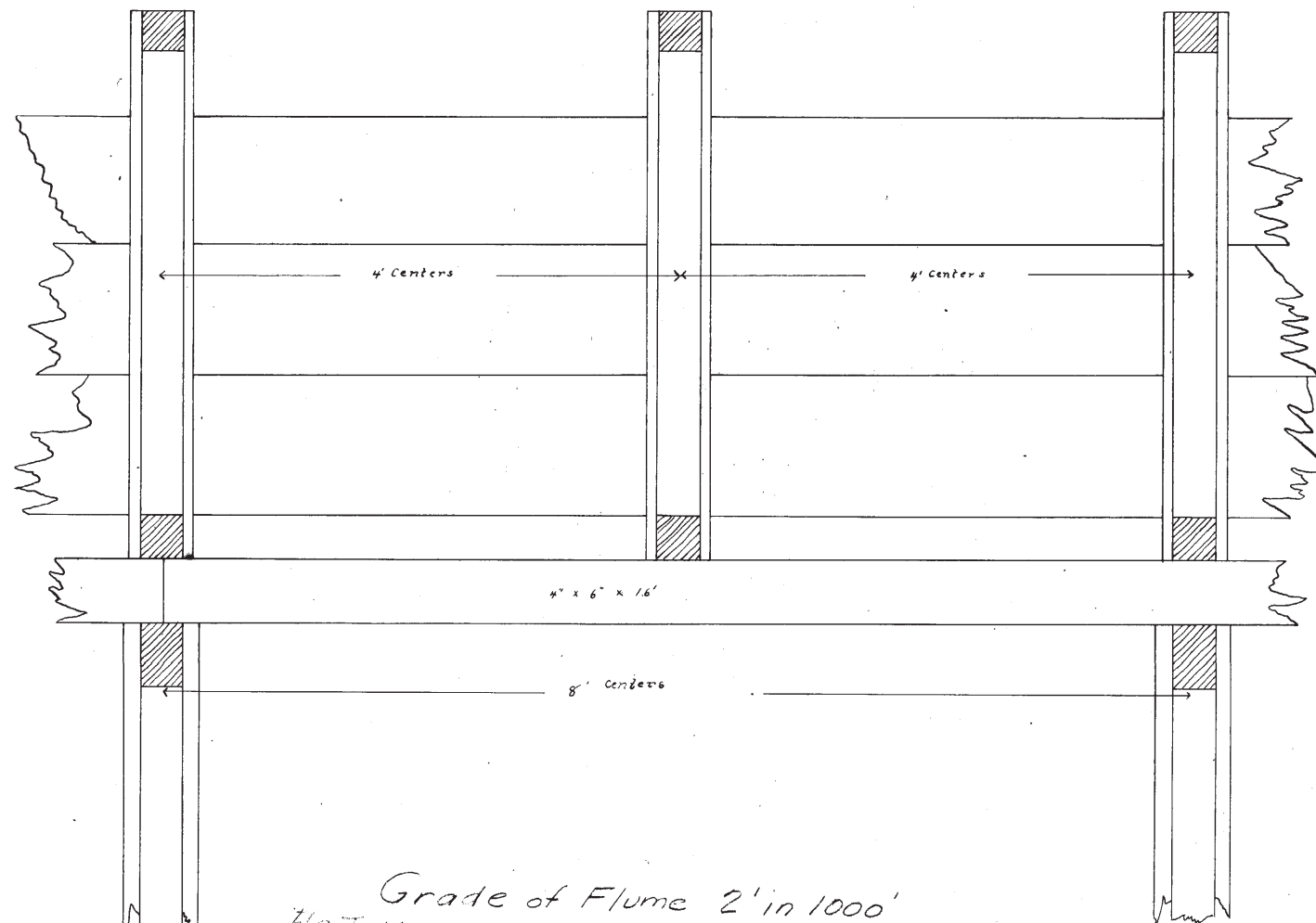
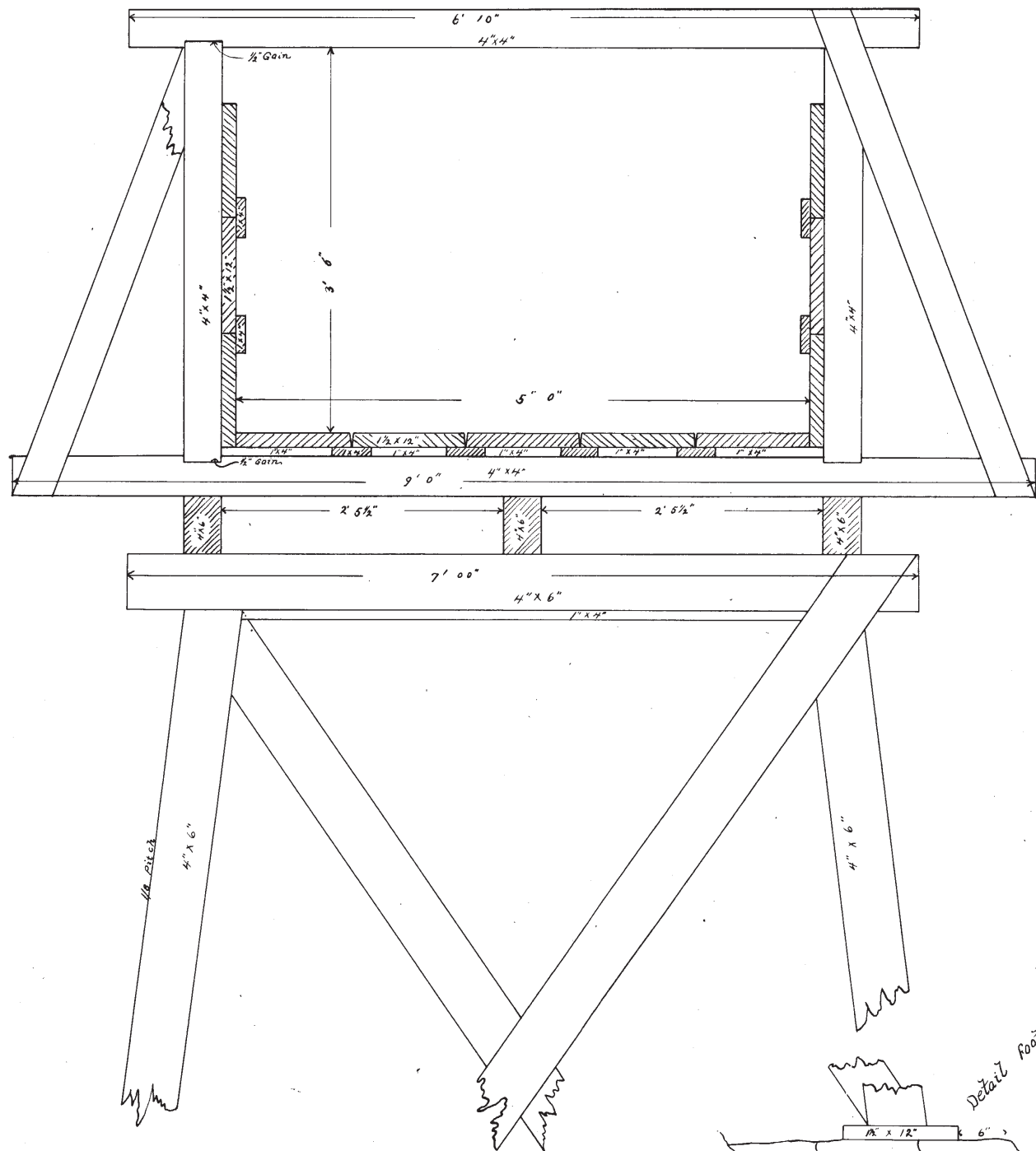

Grade of Flume 2' in 1000'
H.C.T. Max Capacity of Flume 75 Sec Ft. KAWAOKA Power House No. 2.

Detail Foot of Bend

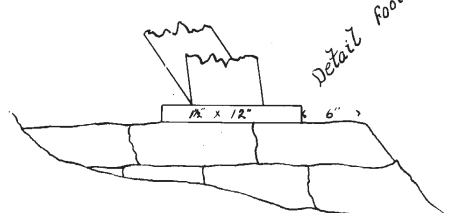

Detail Foot of Bend

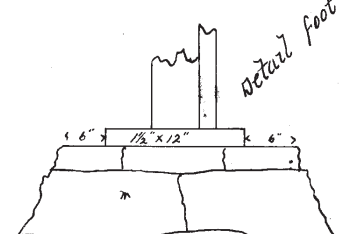

~~517~~
Mt Whitney Power Co.
~~J.F. 13~~ Visalia, Calif.
Scale
Drawn

Kaweah #2

517248

INVENTOR ~~517~~

Kaweah No. 2 Forebay

Note: Drawings Included in Exhibit F

Kaweah No. 3 Powerhouse and Penstock

Note: Additional Drawings Included in Exhibit F



SOUTH ELEVATION

Note:-
 All wall reinforcing to be $\frac{3}{8}$ " Sq. rods, unless otherwise noted, placed about 24" on centers each way; 2 rods to be placed where noted.
 See drawings E-385 for roof girders and cornice reinforcing.
 "E-386" - beams and roof slab.

POWER HOUSE - SOUTH ELEVATION.
1/8" = 1'-0"

S. H. Howard
 B.W.
 R.R.W. 8/2/12
 E-376
John C. ...

31-29

Marble Fork Diversion Dam

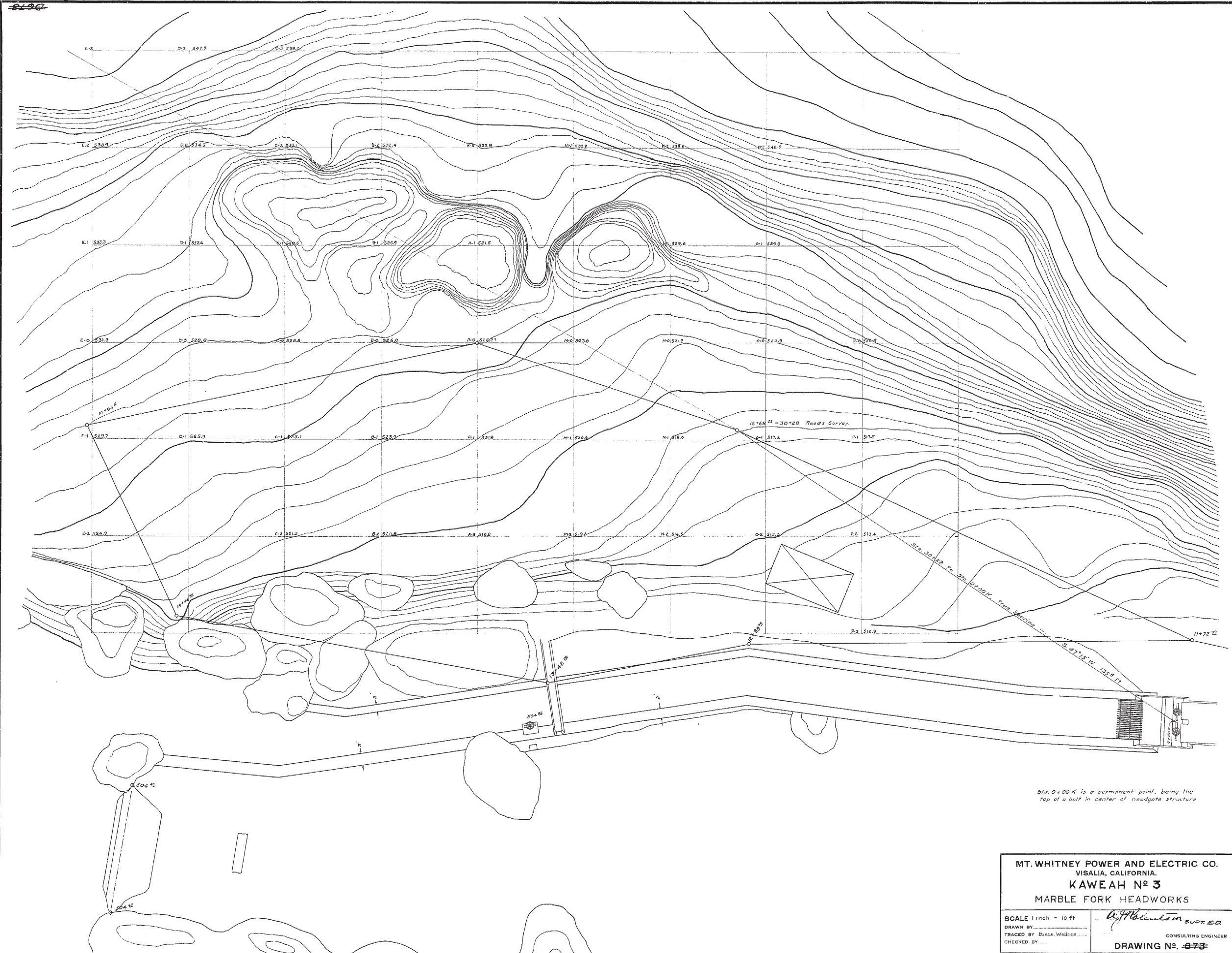

Sta. 0+00 K is a permanent point, being the top of a bolt in center of headgate structure

MT. WHITNEY POWER AND ELECTRIC CO. VISALIA, CALIFORNIA. KAWEAH No 3 MARBLE FORK HEADWORKS	
SCALE 1 inch = 10 ft DRAWN BY _____ TRACED BY Bruce Wallace CHECKED BY _____	<i>D. J. Williams</i> Supt. E.O. CONSULTING ENGINEER DRAWING No. 673

Middle Fork Diversion Dam

0629

Kaweah No 3

Middle Fork Dam

Scale 1/2"

JAM^{CD} 9/14/12

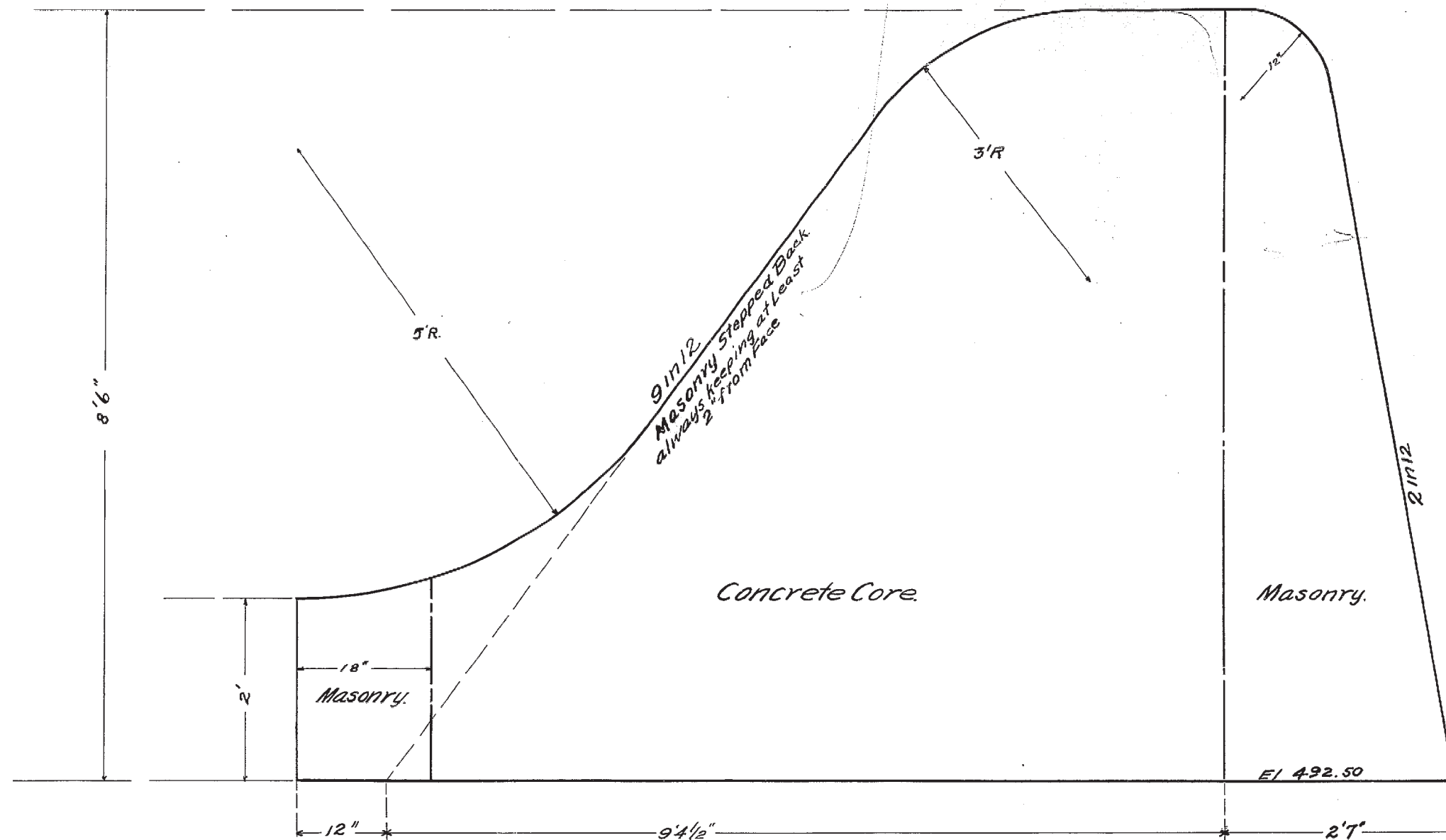

32040

0629
32040

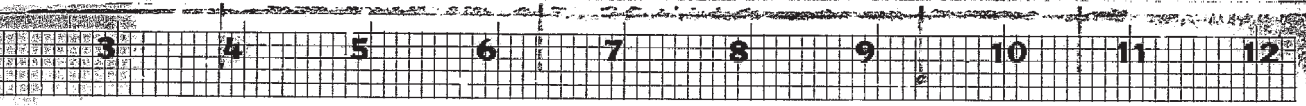

MICROFILMED FROM

Middle Fork Flowline/
Kaweah No. 3 Flowline

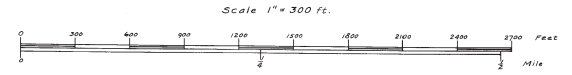
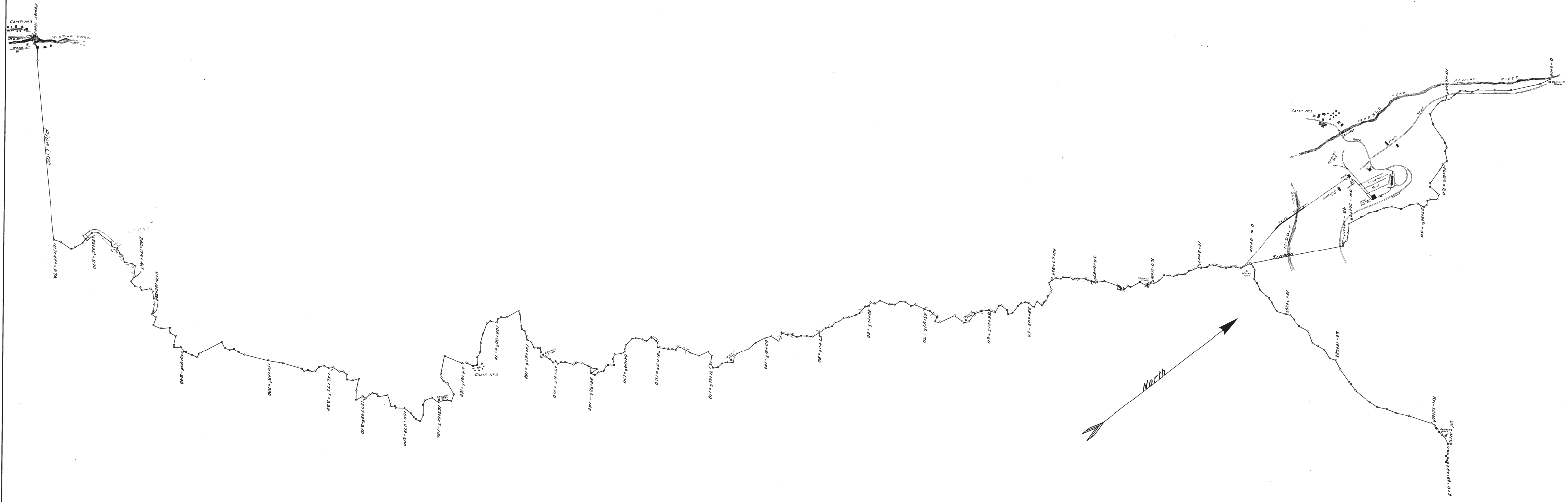

State of California ss.
 County of Tulare ss.
 I, JOHN COFFEY HAYS, Consulting Engineer
 of the Mt. Whitney Power and Electric Co., do hereby
 certify that this is a true and correct copy of
 Draw. NRE-318 as filed in the Company's office in
 Visalia.

 Consulting Engineer

MT. WHITNEY POWER AND ELECTRIC CO.
 KAWAHEE No 3
 Conduit Line. Scale 1" = 300 ft.

APPROVED:	ENGINEER
DRAWN BY: J. COFFEY HAYS	DATE
CHECKED BY:	NUMBER: E-318
APPROVED:	CONSULTING ENGINEER

17993

Bearings to be placed on top of flume

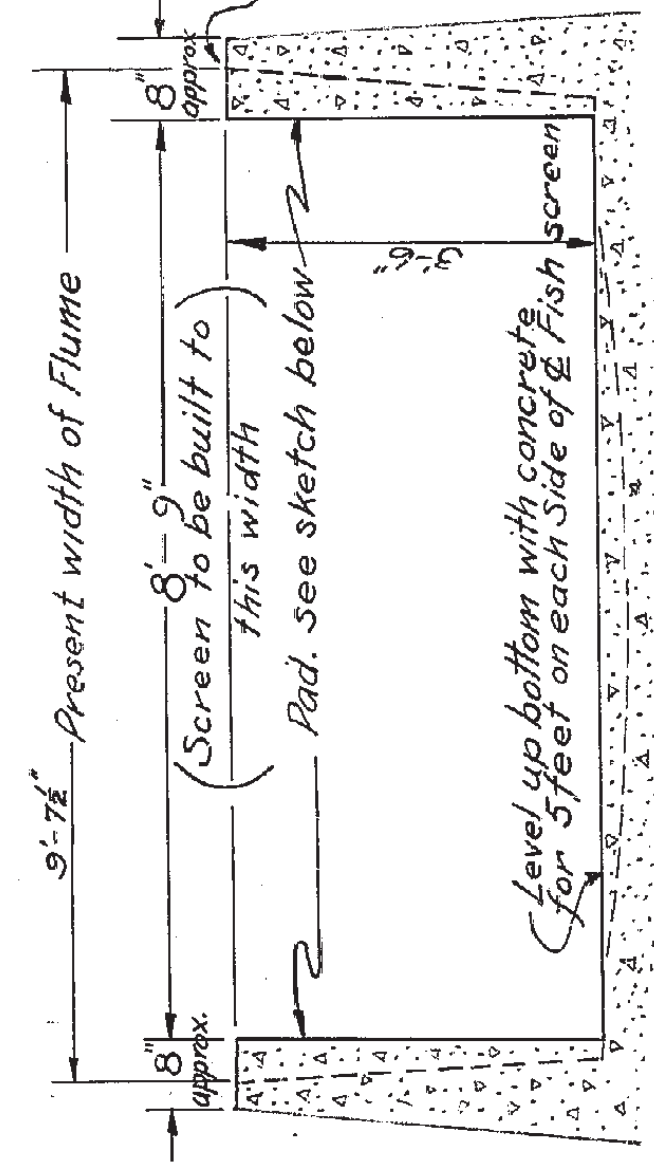

Level up bottom with concrete for 5 feet on each side of Fish screen

CROSS SECTION OF MARBLE FORK FLUME

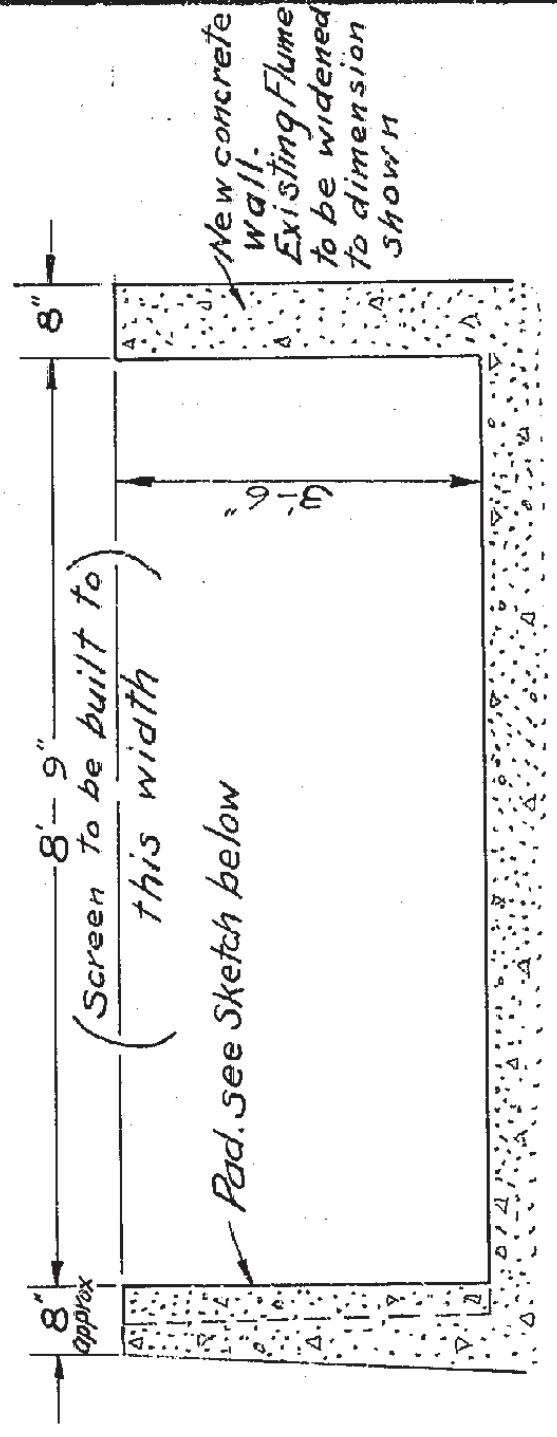

Pad. see sketch below

New concrete wall. Existing flume to be widened to dimension shown

CROSS SECTION OF MIDDLE FORK FLUME

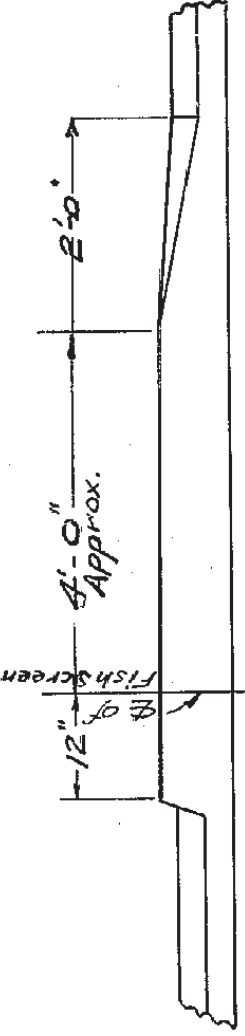

Sketch showing concrete pad on side of flume to straighten batter. This applies to both flumes

B.M. 30255-1-1

APPROVED	NO.	DATE	REVISIONS	BY	DRAWN	WMB	APPROVED	LOCATION:
					TRACED	RWH	<i>[Signature]</i>	KAWEAH NO 3
					CHECKED	SFC	<i>[Signature]</i>	SOUTHERN CALIFORNIA EDISON CO.
					DATE	11-2-23	<i>[Signature]</i>	DETAILS OF MARBLE FORK AND MIDDLE FORK FLUMES FOR INSTALLING FISH SCREEN
					SCALE	1" = 1 FT.		

17993

30255-1103

DATE	CHARGE NO.	CONSTRUCTION DEPARTMENT	OPERATING DEPT.	TEST DEPT.	PROTECT. ENGR.	SHOP	ENGR. INSP.	REQ.	ELEC.	MECH.	STRUCT.
1-29		Letter									
REMARKS:-											

FORMERLY NUMBERED 30255-1103

30255-1103

517340

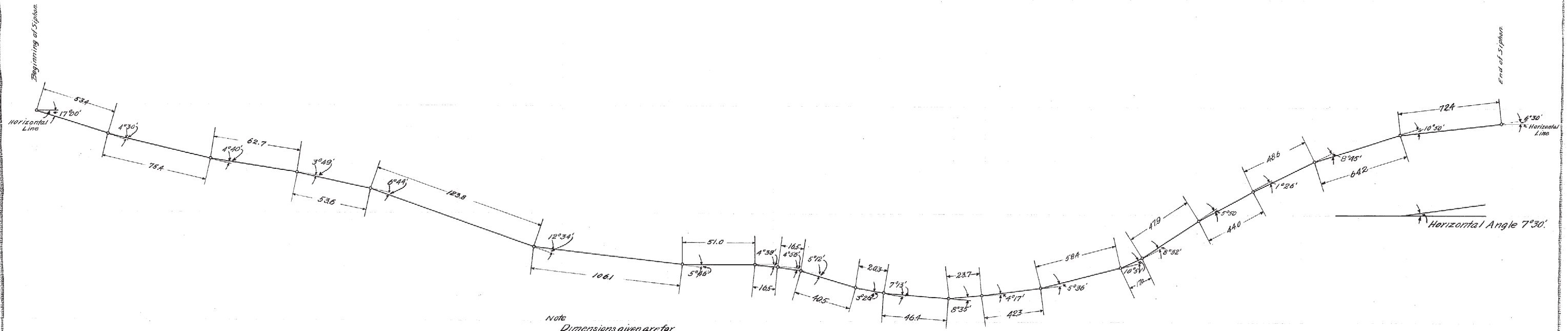

Note
 Dimensions given are for
 Bottom of Trench.
 1085-48" 1/4" Thick Pipe.

THIS DRAWING
 SUPERSEDES
 DRWG. No. 517339

MT. WHITNEY POWER AND ELECTRIC CO.
KAWAHAH N° 3
 Profile of Siphon Pipe Line
 Scale H.V. 30'

APPROVED: *S. L. Stovall*
 ENGINEER

DRAWN BY: *JAMES W. HARRIS* DATE 4/12/12

CHECKED BY: _____ NUMBER *D-324*

APPROVED: *John C. Harris*
 CONSULTING ENGINEER

DATE 4/12/12

This Dwg Supersedes # D-317

517340

D-324

Kaweah No. 3 Forebay

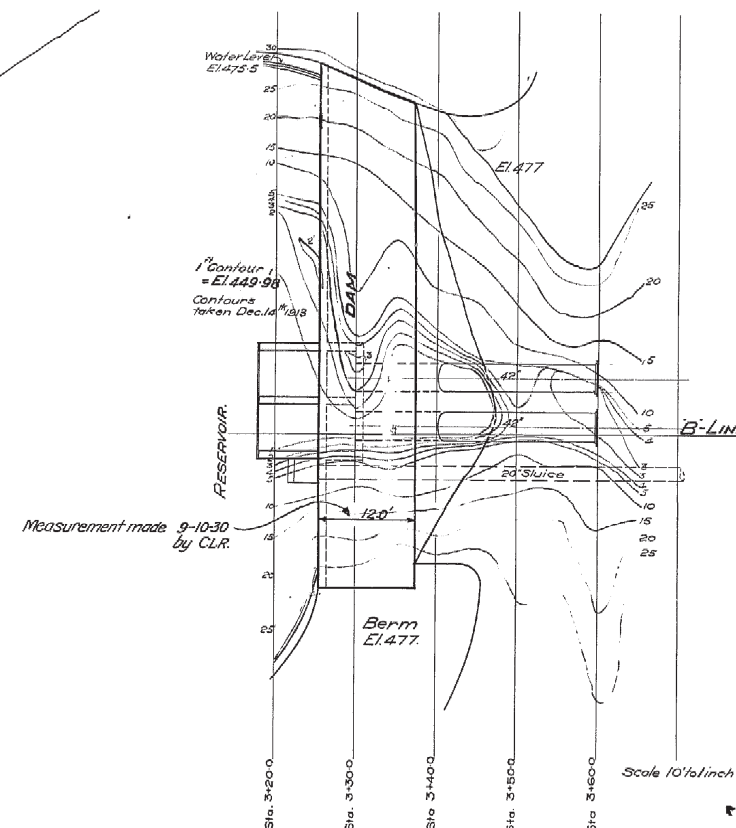
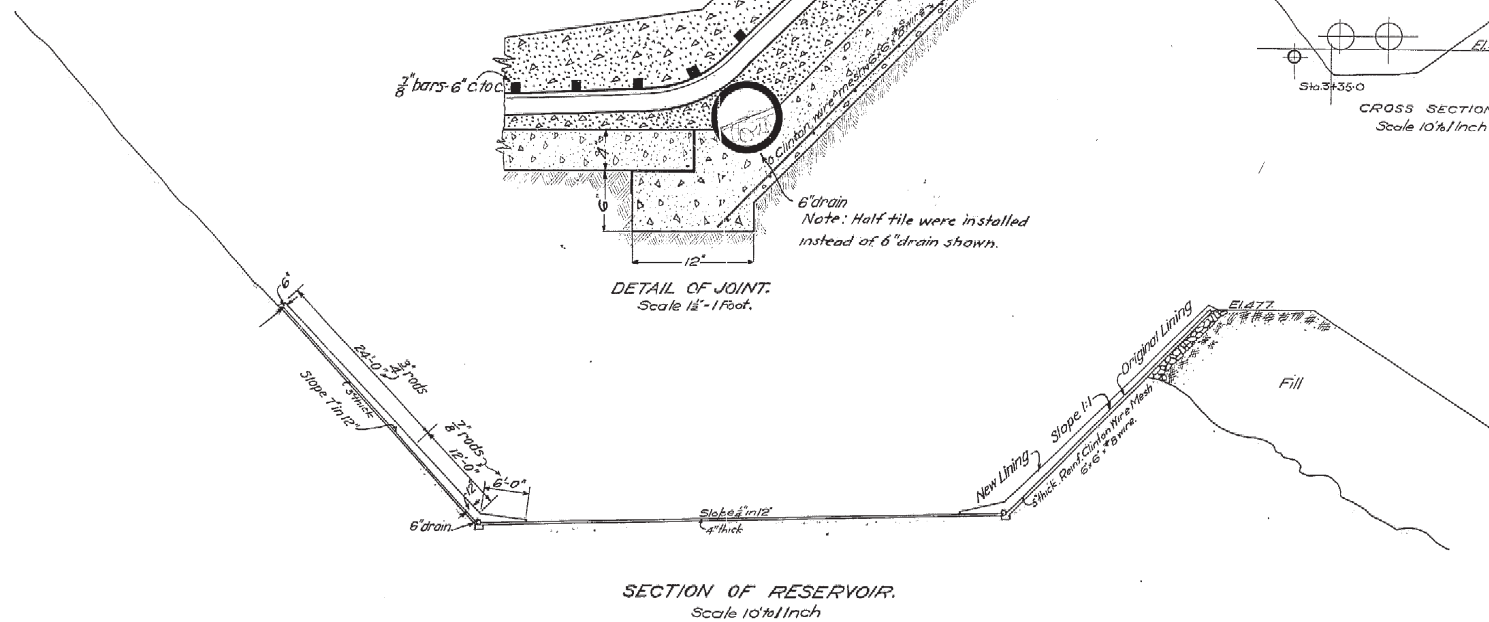
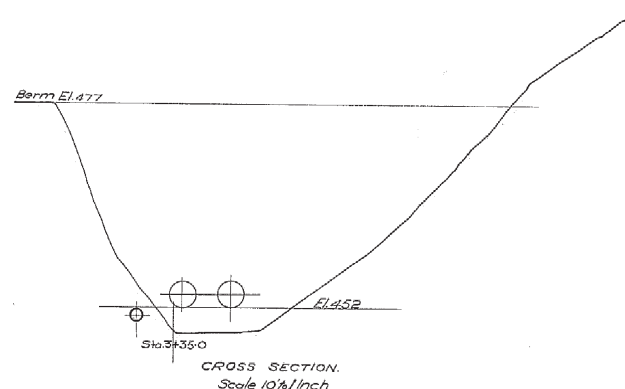
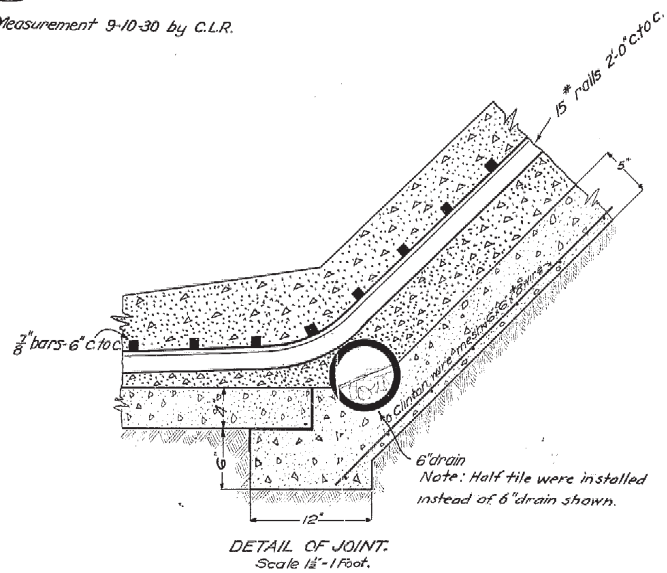
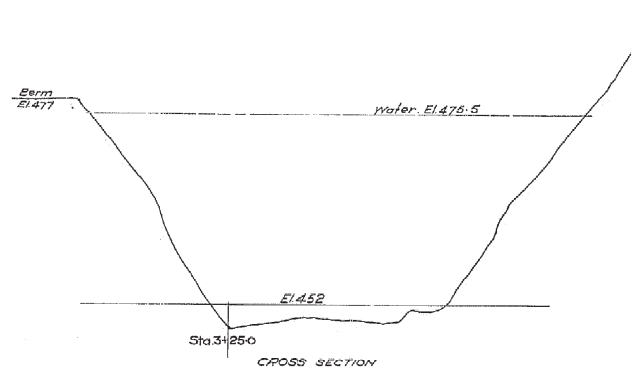
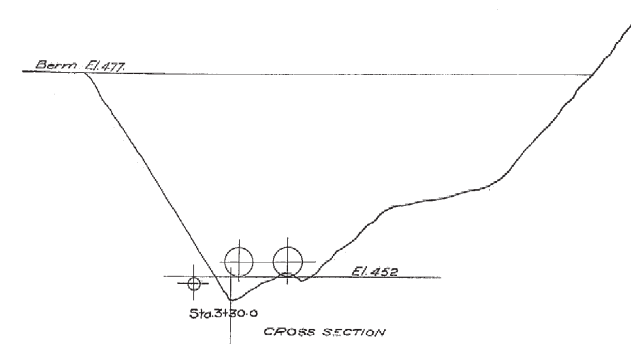
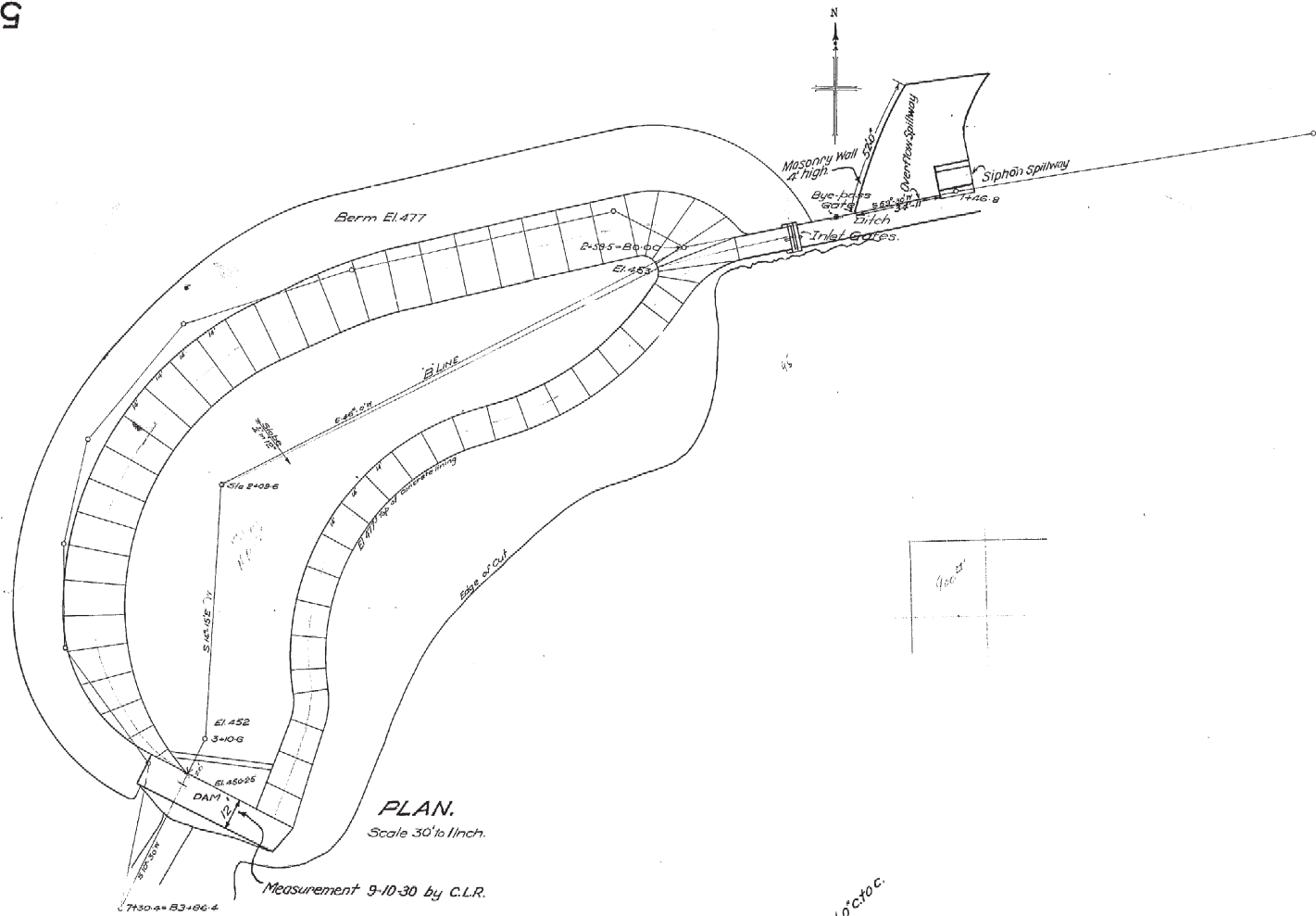

REVISED 9-3-31
This drawing shows structure as built.
J. H. Johnson

517344

MT. WHITNEY POWER AND ELECTRIC CO. VISALIA, CALIFORNIA. KAWEAH NO. 3 REGULATING RESERVOIR.	
SCALE as noted DRAWN BY I. B. H. Jan. 2, 1934 TRACED BY I. B. H. Jan. 2, 1934 CHECKED BY	CHIEF ENGINEER CONSULTING ENGINEER DRAWING NO. D-2500



